

FACTORY X-6³ Setup sheet

Arm0 - V1.1

Driver: Alexis Dufau Cazenave Date: 03/11/2013
 Event: course Amicale Bosdaros
 Track: Bosdaros carpet

Track Condition

Composition: Astroturf Blue Groove Carpet Clay Dirt Grass Other: _____
 Layout: Open Tight Surface: Bumpy Smooth Grip: Low Medium High

Front Suspension

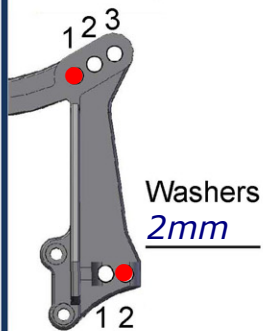

Toe: _____ 0° Axles: Trailing Inline
 Camber: _____ 0° Caster Block: 20° 25° 30°
 Ride Height: 16 Ackermann: Forward Back

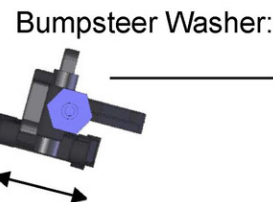
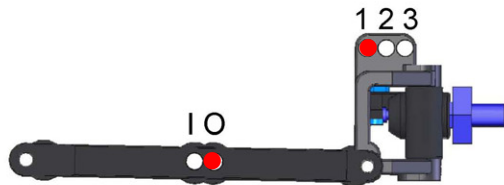

Forward Hub Position Back

Front Shocks

Brand: Durango slim
 Spring: dark green
 Piston: 2X1.4
 Oil: 35 Emulsion: Yes No
 Limiters: _____

Front Tires

Tire: Stagger cut low profile
 Insert: no
 Wheels: asso

Rear Suspension

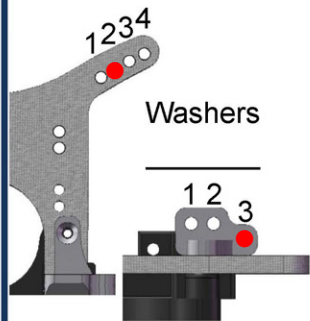

Camber: _____ 1°
 Ride Height: 16,5
 Transmission Height: 0
 Swaybar: none

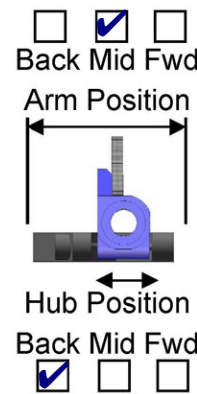
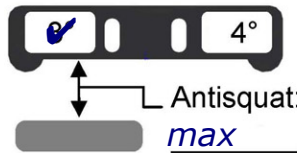
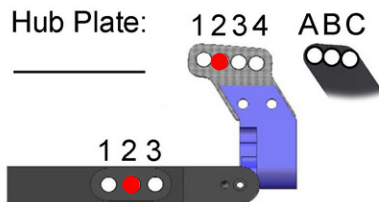

Rear Shocks

Brand: Durango slim
 Spring: light green
 Piston: 3X1.3
 Oil: 30 Emulsion: Yes No
 Limiters: _____

Rear Tires

Tire: mini pin
 Insert: proline foam
 Wheels: avid

Weighs:

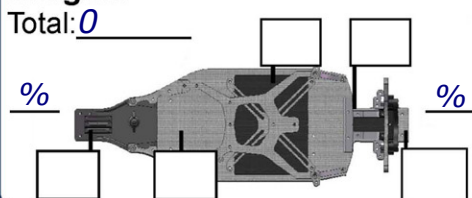

Comments:

the car is lazy forward, i think about testing 25° caster block, insert sweep in the rear tire, rear brand more right and inline axles for more aggressive car !

Body & wing: x factory

Battery: saddle orion
 Motor: savox 7.5T
 Gearing: 23x78
 ESC: orion
 ESC Settings: soft