

DRIVER, TRACK AND RESULTS

DRIVER _____ COUNTRY _____ WEATHER AIR TEMP _____ TRACK TEMP _____ DRY INTERMEDIATE WET

RACE _____ DATE _____ QUALY POS. _____ STARTING POS. _____ FINAL POS. _____ FASTEST LAP _____

TRACK _____ TYPE INDOOR OUTDOOR STYLE TIGHT MEDIUM OPEN

SURFACE GRIP LOW MEDIUM HIGH _____ CONDITION SMOOTH ROUGH

TYPE HARD PACKED CLAY CARPET MULTI/SURFACE GRASS BLUE GROOVE DIRT ASTRO-TURF

FRONT	SHOCK ABSORBERS	REAR
	cst OIL	cst
SPRINGS		
mm	REBOUND	mm
mm	LIMITERS	mm
N° HOLES	∅ mm PISTONS	N° HOLES ∅ mm
PISTONS TYPE <input type="checkbox"/> STOCK <input type="checkbox"/> CONICAL <input type="checkbox"/> SQUARE		
<input type="checkbox"/> SHORT <input type="checkbox"/> LONG SPRING BUCKETS <input type="checkbox"/> SHORT <input type="checkbox"/> LONG		
<input type="checkbox"/> BLADDER	SEAL TYPE	<input type="checkbox"/> BLADDER <input type="checkbox"/> EMULSION

ANTI-ROLL BARS	
<input type="checkbox"/> FRONT	<input type="checkbox"/> REAR
FRONT ANTI-ROLL BAR _____ mm	REAR ANTI-ROLL BAR _____ mm

FRONT	DIFFERENTIAL	REAR
<input type="checkbox"/> BALL DIFFERENTIAL	<input type="checkbox"/> BALL DIFFERENTIAL	<input type="checkbox"/> BALL DIFFERENTIAL
<input type="checkbox"/> GEAR DIFF	cst	<input type="checkbox"/> GEAR DIFF
cst		cst
FR DIFF HEIGHT		RR DIFF HEIGHT

GEARING	
PINION _____ Teeth	SPUR GEAR _____ Teeth

ELECTRONICS	
BATTERY	
BRAND _____	CAPACITY _____ mAh
MOTOR	
BRAND _____	TYPE _____ TIMING _____
ESC	
BRAND _____	TYPE _____

AERODYNAMIC CONFIGURATION	
BODY BRAND _____	TYPE _____
REAR WING BRAND _____	TYPE _____
REAR WING WIDTH _____	REAR WING LIP _____ mm
RR WING ANGLE <input type="checkbox"/> 0° <input type="checkbox"/> 2° <input type="checkbox"/> 4° <input type="checkbox"/> 6° <input type="checkbox"/> 8°	MOUNT <input type="checkbox"/> STD <input type="checkbox"/> LOW
FRONT WING <input type="checkbox"/> YES <input type="checkbox"/> NO	TYPE _____

FRONT TIRES	Controlled Tire	REAR
MAKE _____	<input type="checkbox"/>	
TYPE _____		
COMPOUND _____		
INSERTS _____		
WHEELS _____		
ADDITIVE _____		

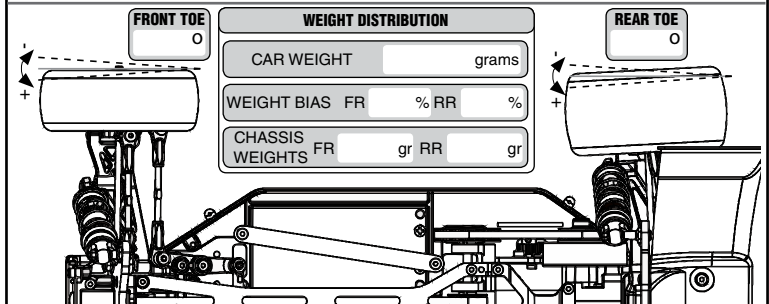
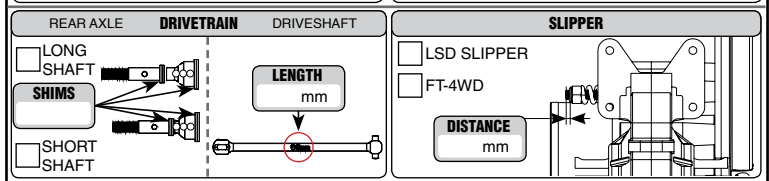
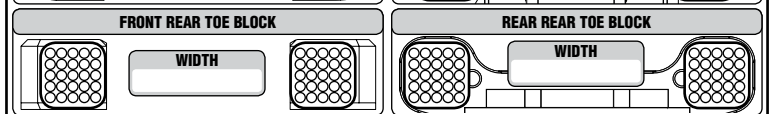
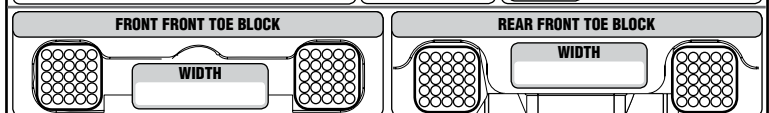
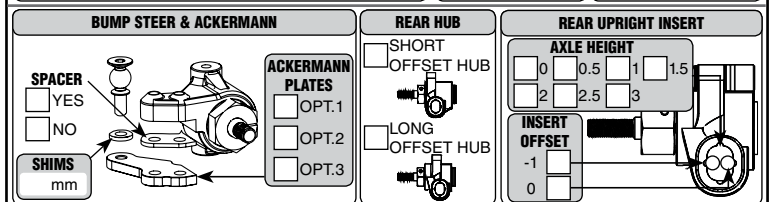
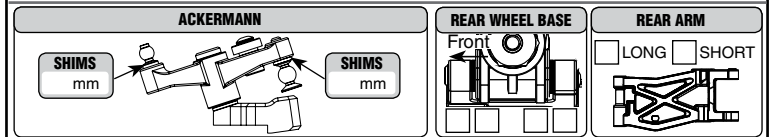
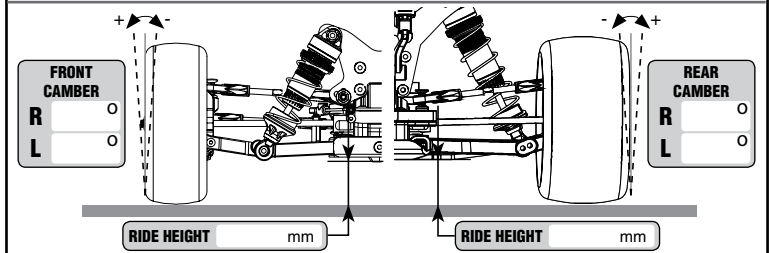
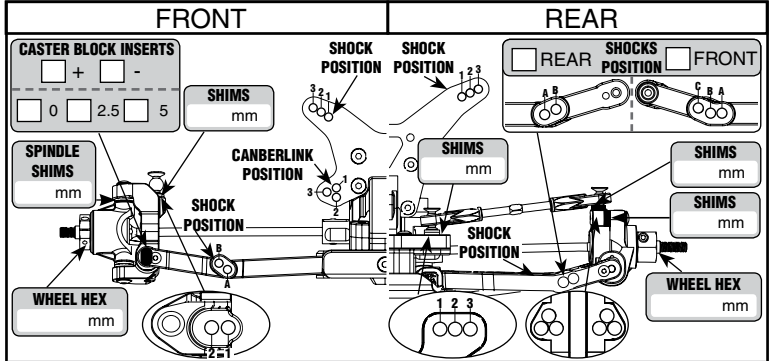

REMARKS _____