

DRIVER, TRACK AND RESULTS

DRIVER _____ COUNTRY _____ WEATHER AIR TEMP _____ TRACK TEMP _____ DRY INTERMEDIATE WET

RACE _____ DATE _____ QUALY POS. _____ STARTING POS. _____ FINAL POS. _____ FASTEST LAP _____

TRACK _____ TYPE INDOOR OUTDOOR STYLE TIGHT MEDIUM OPEN

SURFACE GRIP LOW MEDIUM HIGH _____ CONDITION SMOOTH ROUGH

TYPE HARD PACKED CLAY CARPET MULTI/SURFACE GRASS BLUE GROOVE DIRT ASTRO-TURF

FRONT SHOCK ABSORBERS REAR

cst OIL _____ cst

SPRINGS _____

mm REBOUND _____ mm

mm LIMITERS _____ mm

N° HOLES _____ mm PISTONS N° HOLES _____ mm

PISTONS TYPE STOCK CONICAL SQUARE

SHORT LONG SPRING BUCKETS SHORT LONG

BLADDER SEAL BLADDER
 EMULSION TYPE EMULSION



FRONT **ANTI-ROLL BARS** REAR

FRONT ANTI-ROLL BAR _____ mm REAR ANTI-ROLL BAR _____ mm

FRONT DIFFERENTIAL REAR

BALL DIFFERENTIAL BALL DIFFERENTIAL

GEAR DIFF _____ cst GEAR DIFF _____ cst

FR DIFF HEIGHT  REAR DIFF HEIGHT 

GEARING

PINION _____ Teeth SPUR GEAR _____ Teeth

ELECTRONICS

BATTERY

BRAND _____ CAPACITY _____ mAh

MOTOR

BRAND _____ TYPE _____ TIMING _____

ESC

BRAND _____ TYPE _____

AERODYNAMIC CONFIGURATION

BODY BRAND _____ TYPE _____

REAR WING BRAND _____ TYPE _____

REAR WING WIDTH _____ REAR WING LIP _____ mm

RR WING ANGLE 0° 2° 4° 6° 8° MOUNT STD LOW

FRONT WING YES NO TYPE _____

FRONT TIRES Controlled Tire REAR

MAKE _____

TYPE _____

COMPOUND _____

INSERTS _____

WHEELS _____

ADDITIVE _____

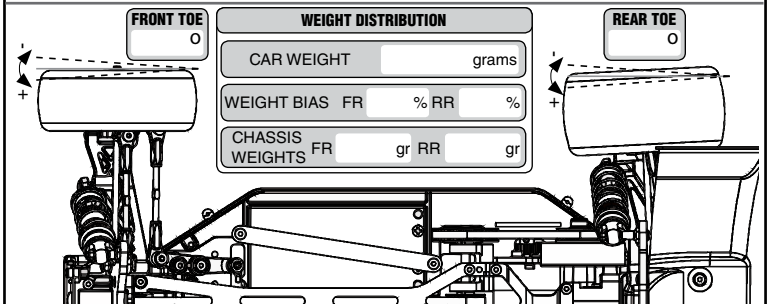
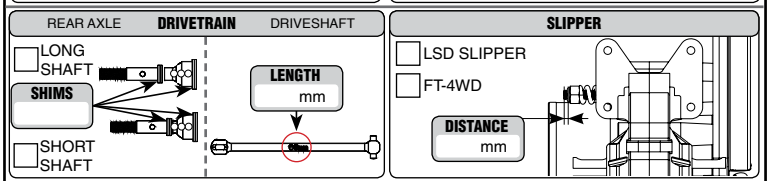
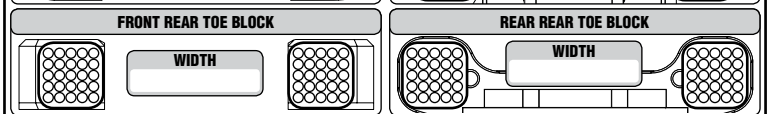
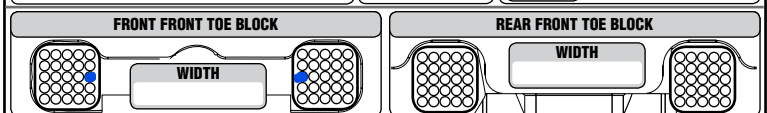
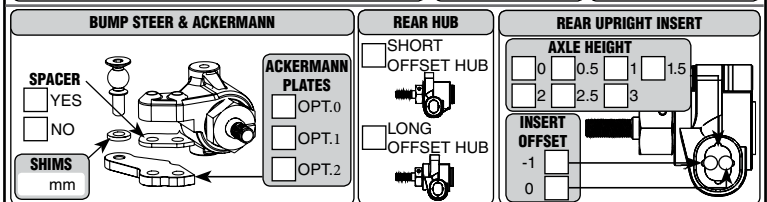
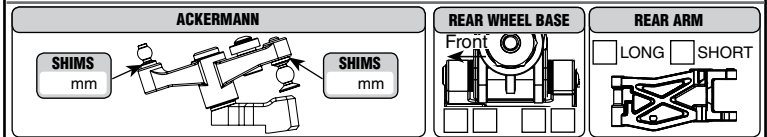
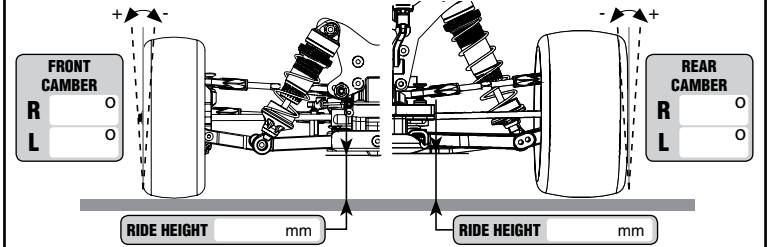
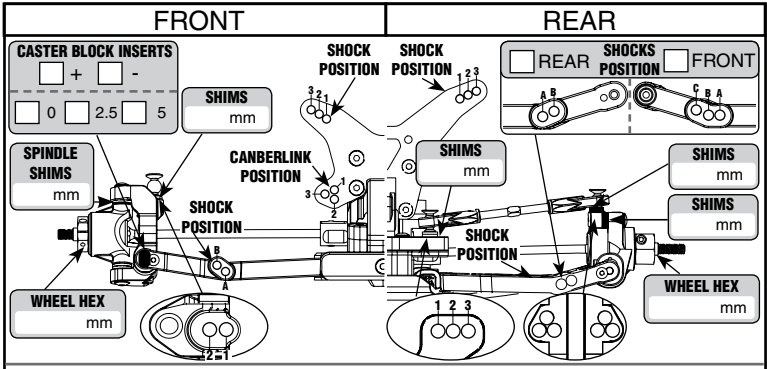

REMARKS _____