

InfernoMP10E SETUP SHEET

ver.1.00



Driver Reno Savoya		Date 25/02/23		Track DNC Indoor Condition: 5°C loamy, bumpy		Event Dirt Nitro Challenge		Spur Gear <input checked="" type="checkbox"/> 46T(Std.) <input type="checkbox"/> 47T <input type="checkbox"/> 48T		Pinion Gear 15 T	
Motor Konect 2100kv	Battery 8200 Gens Ace	ESC Hobbywing 140 SCT	Tires AKA Grid Iron Compound: US			Tire Insert AKA	Wheel AKA	Body TKI2			

● Diff. Gear Set-Up

	Front	Center	Rear
Diff. Gear	<input checked="" type="checkbox"/> Std. <input type="checkbox"/> LSD	<input checked="" type="checkbox"/> Std. <input type="checkbox"/> LSD	<input checked="" type="checkbox"/> Std. <input type="checkbox"/> LSD
	<input type="checkbox"/> IFW621	<input type="checkbox"/> IFW622	<input type="checkbox"/> IFW621
	Ring Gear <input checked="" type="checkbox"/> 43/13 <input type="checkbox"/> 42/12	# 7 000	# 5 000
			Ring Gear <input checked="" type="checkbox"/> 43/13 <input type="checkbox"/> 42/12

● Shock Set-Up

	Front	Rear
Shock Type	P: w/Diaphragm A: Aeration 50 - P	58 - P
Shock Piston	B: Black W: White T: Taper T: 8x1,2	W: 8x1,3
Shock Oil	# 500	# 600
Shock Spring	Length 70mm grey	Length 81mm red

● Ride Height

Front	Rear
25 mm	29 mm

● Rebound

Front	Rear
107 mm	123 mm

● Camber Angle

Front	Rear
+ -2°	+ -3°

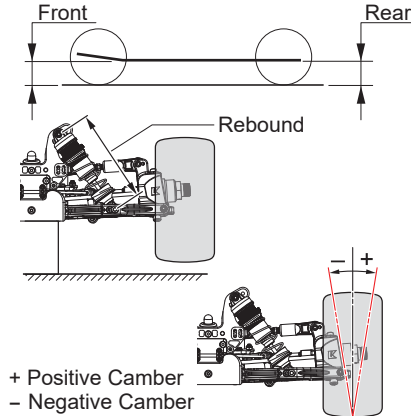

● Toe Angle

Front	Rear
+ -2°	<input type="checkbox"/> 2.5° <input checked="" type="checkbox"/> 3° <input type="checkbox"/> 3.5°

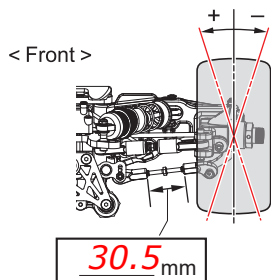

● Wheelbase

Collar of Rear Hub	Front Side 5 mm
	Rear Side 0 mm

● Shock Mount Position

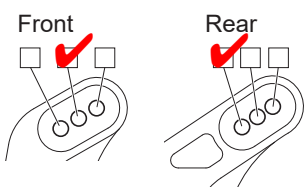

Shock Stay	
Front	<input type="checkbox"/> Std. <input checked="" type="checkbox"/> Long
Rear	<input type="checkbox"/> Std. <input checked="" type="checkbox"/> Long
Rear Upper Shock Bush	
	<input checked="" type="checkbox"/> Std. <input checked="" type="checkbox"/> Long
Sus. Arm	
Front	<input type="checkbox"/> In <input checked="" type="checkbox"/> Out
Rear	<input type="checkbox"/> In <input checked="" type="checkbox"/> Out

● Rear Upper Arm Position

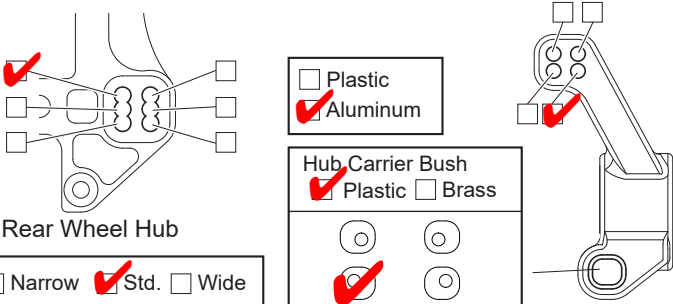

<input type="checkbox"/> Plastic	<input checked="" type="checkbox"/> Aluminum
Hub Carrier Bush	
<input checked="" type="checkbox"/> Plastic	<input type="checkbox"/> Brass

● Rear Wheel Hub

<input type="checkbox"/> Narrow	<input checked="" type="checkbox"/> Std.	<input type="checkbox"/> Wide
---------------------------------	--	-------------------------------

● Front Sus. Arm

<input checked="" type="checkbox"/> Soft (Std.)	<input type="checkbox"/> Hard
---	-------------------------------

● Front Hub Carrier

<input type="checkbox"/> Plastic	<input checked="" type="checkbox"/> Aluminum
<input type="checkbox"/> 13°	<input type="checkbox"/> 16° <input type="checkbox"/> 17.5° <input checked="" type="checkbox"/> 19°

● Front Sus. Bush

Rear Side	<input checked="" type="checkbox"/>
-----------	-------------------------------------

● Front Upper Arm Position

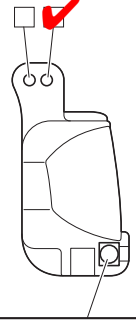
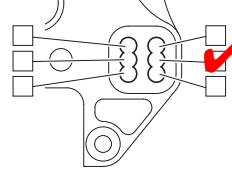

● Front Wheel Hub

<input type="checkbox"/> Narrow	<input checked="" type="checkbox"/> Std.	<input type="checkbox"/> Wide
---------------------------------	--	-------------------------------

Lower Bush	<input type="checkbox"/> Plastic	<input type="checkbox"/> Brass
	-1° <input checked="" type="checkbox"/>	0° <input type="checkbox"/> +1° <input type="checkbox"/>

● Rear Sus. Bush

Front Side	<input type="checkbox"/>	<input type="checkbox"/>	<input type="checkbox"/>	<input checked="" type="checkbox"/>
Rear Side	<input type="checkbox"/>	<input type="checkbox"/>	<input checked="" type="checkbox"/>	<input checked="" type="checkbox"/>

● Rear Sus. Arm

<input type="checkbox"/> Soft (Std.)	<input checked="" type="checkbox"/> Hard
Rear Sus. Bush	
Short	<input type="checkbox"/>
Medium	<input type="checkbox"/>
Long	<input checked="" type="checkbox"/>

● Servo Horn

Steering	Throttle
<input type="checkbox"/> Plastic	<input type="checkbox"/> Plastic
<input type="checkbox"/> Alum. Long	<input type="checkbox"/> Aluminium
<input checked="" type="checkbox"/> Alum. Short	

● Steering Plate

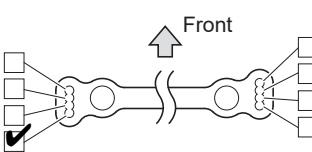

● Sway Bar

Front	Rear
\varnothing 2,4mm	\varnothing 2,7mm
0 mm	2 mm

● Weight

Front	Rear
<input checked="" type="checkbox"/> None	<input type="checkbox"/> None
<input type="checkbox"/> IFW604-10	<input type="checkbox"/> IFW605-10
<input type="checkbox"/> IFW604-20	<input checked="" type="checkbox"/> IFW605-20
<input type="checkbox"/> other	<input type="checkbox"/> other

● Wing

<input checked="" type="checkbox"/> IF491(TK14)	Flap <input type="checkbox"/> None
	<input type="checkbox"/> 5mm
	<input type="checkbox"/> 8mm
	<input checked="" type="checkbox"/> Holes

IFW631 and IFW632 carbon shock towers
FINO-42 RSRC 10mm wing spacer

Notes