

Front Suspension

Ride Height: _____
 Camber: _____
 Toe: _____
 Arm Type: _____
 Tower Type: _____
 Caster Block Insert: _____
 Bulkhead Type: _____
 Kick-Up Angle: _____
 Wheel Hex: _____

Anti Roll Bar:
 None
 White (0.8mm)
 Gray (0.9mm)
 Blue (1.0mm)
 Other: _____

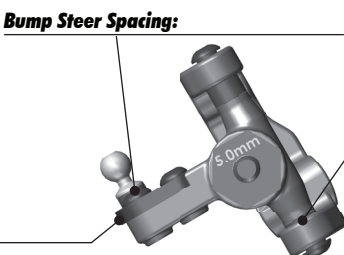

Axle Height:
 +3
 +2
 +1
 0
 SCH1256

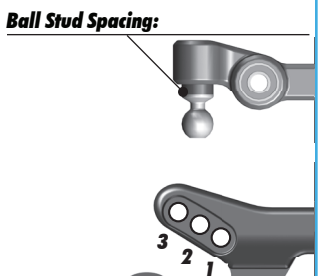

Steering Plate: _____

Steering Stop Spacing: _____

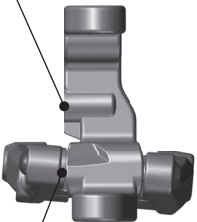

Ball Stud Spacing: _____

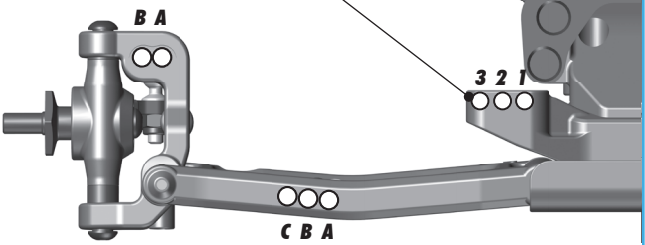

Caster Block Spacing: _____

Notes

Rear Suspension

Ride Height: _____
 Camber: _____
 Wheel Hex: _____
 CVA Pin Location: _____
Hub Spacing:
 Forward Middle Back
Shock Mounting Position:
 Front of Arm Rear of Arm

Anti Roll Bar:
 None
 White (1.2mm)
 Gray (1.3mm)
 Blue (1.4mm)
 Other: _____

C Mount Inserts: 1° 0.5°
 Aluminum Brass

D Mount Inserts: 1° 0.5°
 Aluminum Brass

Rear Hub Link Setting:
 Plastic Hub Aluminum Hub



Ball Stud Spacing:

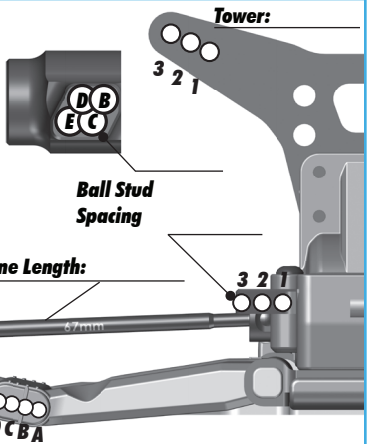

Hub Insert:
 0 (0/3↑)
 +1 (1/2↑)
 +2 (1/2↓)
 +3 (0/3↓)

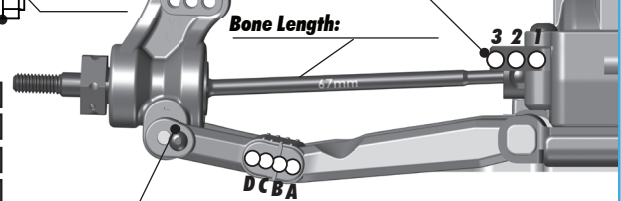

Notes

Electronics, Drivetrain & Shocks

Radio: _____ **Servo:** _____
EPA: Throttle: _____ % Brake: _____ %
ESC: _____
ESC Settings: _____
Motor: _____ **Timing:** _____
Pinion: _____ **Spur:** _____
Battery: _____
Battery Position: _____

Drivetrain: _____ **Height:** _____
Transmission:
 3 Gear 4 Gear
 Stand Up Layback
 Ball Diff:
 Gear Diff:
Slipper Clutch: _____
of Pads: _____

Shocks:	Front	Rear
Piston:		
Fluid:		
Spring:		
Limiters:		
Stroke:		
Eyelet Length:		
Cup Offset:		
Notes:		

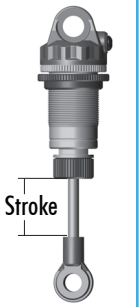

Size: Small Medium Large Extra Large
Surface: Dirt Carpet Astroturf Multi Surface
Traction: Low Medium High Very High
Moisture: Dry Damp Wet
Condition: Indoor Outdoor Dusty Hard Packed
 Bumpy Grooved Smooth Loamy
Temperature: Ambient: _____ Humidity: _____
Notes: _____

Front Tires: _____
Front Compound: _____
Front Insert: _____
Rear Tires: _____
Rear Compound: _____
Rear Insert: _____
Wheel (F/R): _____
Notes: _____

Body: _____
Wing: _____
Wing Angle: 0° 3° 6°
Servo Weights: _____
 None Aluminum Steel Other
Electronic Weights: _____
 None Aluminum Steel Other
Total Vehicle Weight: _____

Comments
