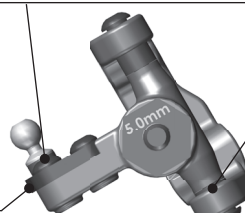

Front Suspension

Ride Height: _____
Camber: _____
Toe: _____
Arm Type: _____
Tower Type: _____
Caster Block Insert: _____
Bulkhead Type: _____
Kick-Up Angle: _____
Wheel Hex: _____

Anti Roll Bar:
None
White (0.8mm)
Gray (0.9mm)
Blue (1.0mm)
Other: _____

Bump Steer Spacing: _____

Axle Height:
+3
+2
+1
0
SCH1256

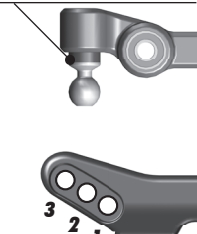
Ball Stud Spacing: _____

Steering Plate: _____

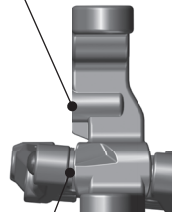
Steering Stop Spacing: _____

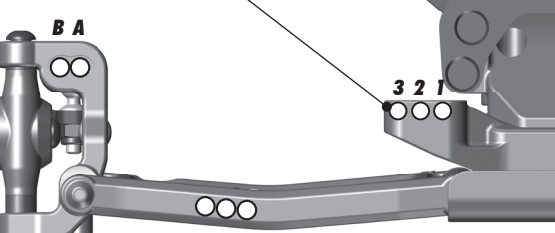
Ball Stud Spacing: _____

Notes

Caster Block Spacing: _____



Rear Suspension

Ride Height: _____
Camber: _____
Wheel Hex: _____
Hub Spacing:
Forward Middle Back
Shock Mounting Position:
Front of Arm Rear of Arm

Anti Roll Bar:
None
White (1.2mm)
Gray (1.3mm)
Blue (1.4mm)
Other: _____

C Mount Inserts: 1° 0.5°
Aluminum Brass

D Mount Inserts: 1° 0.5°
Aluminum Brass

Rear Hub Link Setting:
Plastic Hub Aluminum Hub
Up  Down 

Spacing: _____

Hub Insert:
0 (0/3↑)
+1 (1/2↑)
+2 (1/2↓)
+3 (0/3↓)

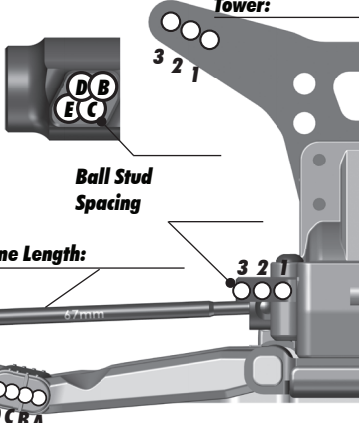
Tower: _____

Ball Stud Spacing: _____
Bone Length: _____

Notes

Track Info, Tires & Aero

Radio: _____ **Servo:** _____
EPA: Throttle: _____ % Brake: _____ %
ESC: _____
ESC Settings: _____
Motor: _____ **Timing:** _____
Pinion: _____ **Spur:** _____
Battery: _____
Battery Position: _____

Drivetrain: _____ **Height:** _____
Transmission:
 3 Gear 4 Gear
 Stand Up Layback
 Ball Diff:
 Gear Diff:
Slipper Clutch: _____
of Pads: _____

Shocks:	Front	Rear
Piston:		
Fluid:		
Spring:		
Limiters:		
Stroke:		
Eyelet Length:		
Cup Offset:		
Notes:		



Size: Small Medium Large Extra Large
Surface: Dirt Carpet Astroturf Multi Surface
Traction: Low Medium High Very High
Moisture: Dry Damp Wet
Condition: Indoor Outdoor Dusty Hard Packed
Bumpy Grooved Smooth Loamy
Temperature: Ambient: _____ Humidity: _____
Notes: _____

Front Tires: _____
Front Compound: _____
Front Insert: _____
Rear Tires: _____
Rear Compound: _____
Rear Insert: _____
Wheel (F/R): _____
Notes: _____

Body: _____
Wing: _____
Wing Angle: 0° 3° 6°
Servo Weights: _____
None Aluminum Steel Other
Electronic Weights: _____
None Aluminum Steel Other
Total Vehicle Weight: _____

Comments
