

EXECUTE
1110 COMPETITION FWD TOURING CAR
F1

INSTRUCTION MANUAL

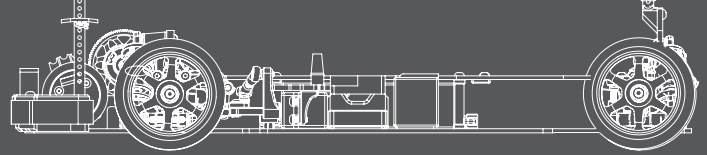

Bag A and Bag Ball

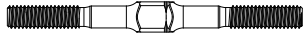

Turnbuckle M3 x 39mm
XP-10157

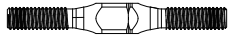

Turnbuckle M3 x 29mm
XP-10156



Turnbuckle M3 x 18mm
XP-10157

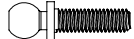

4.8mm Ball End 10mm Thread
XP-10151



4.8mm Ball End 6mm Thread
XP-10149



4.8mm Ball End 5mm Thread
XP-10148

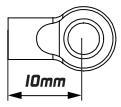
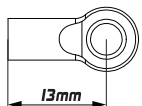
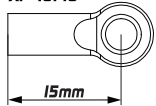

Low Profile Ball End Set
XP-10254



Alu Anti-roll Bar Bushing
XP-10152

2X

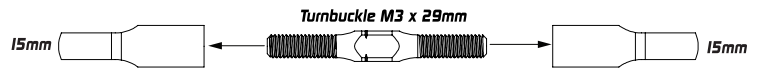

For Rear Camber Link

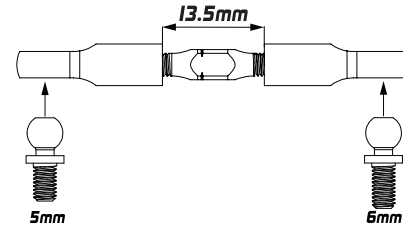

2X

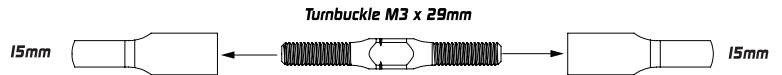

For Front Camber Link

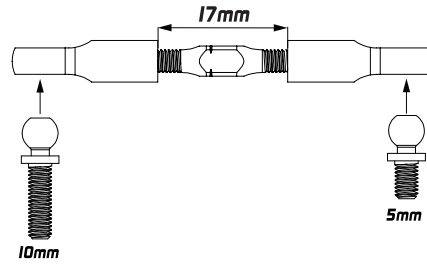

2X

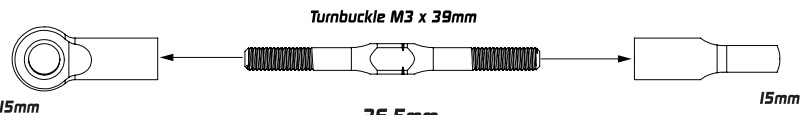

For Steering

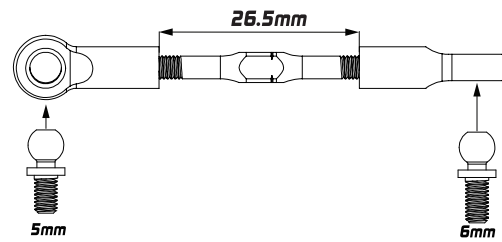

1X

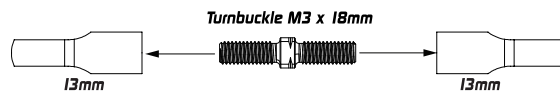

For Servo

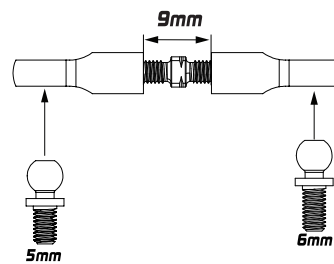

4X

For Swaybar

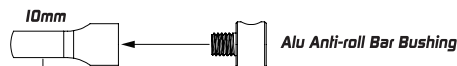

4.8mm Ball End 10mm Thread

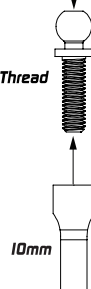

4mm

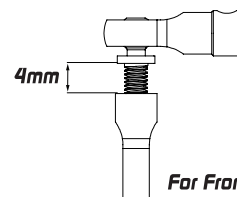

For Front

6mm

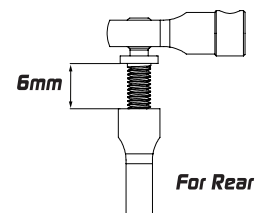

For Rear

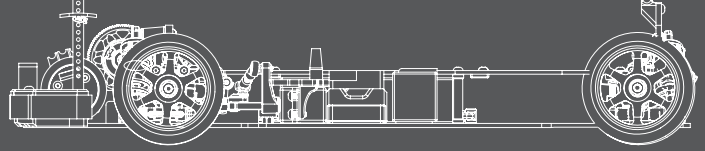

Bag B and Bearing Bag

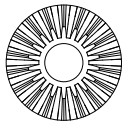

Bevel Gears 18T
XP-10009



Bevel Gears 10T
XP-10009

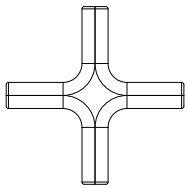

Gear Diff Cross Pin
XP-10009

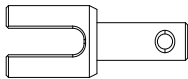

Alu Gear Diff Outdrive Adapter
XP-10125

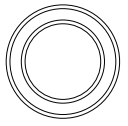

Bearing 10 x 15 x 4mm
XP-40065



O-ring 5 x 2mm
XP-10184



Pin 2 x 9.8mm
XP-40069

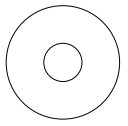

Spacer 5 x 15 x 0.4mm
XP-10181



Spacer 3.6 x 9.5 x 0.2mm
XP-10182



Flat Head Screw M2.5 x 10mm
XP-40044

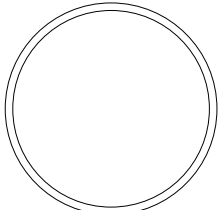

O-ring 25 x 1mm
XP-10183

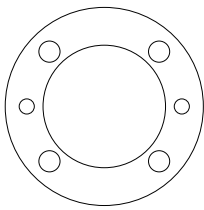

Diff Gasket
XP-10179

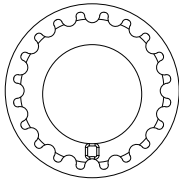

Composite Adjustment
Ball-Bearing Hub
XP-10107

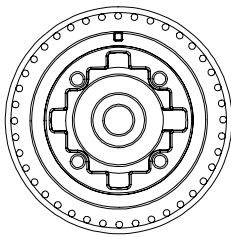

Gear Differential Case
XP-10008

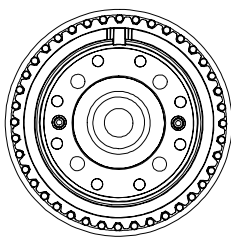

Gear Differential Cover
XP-10008

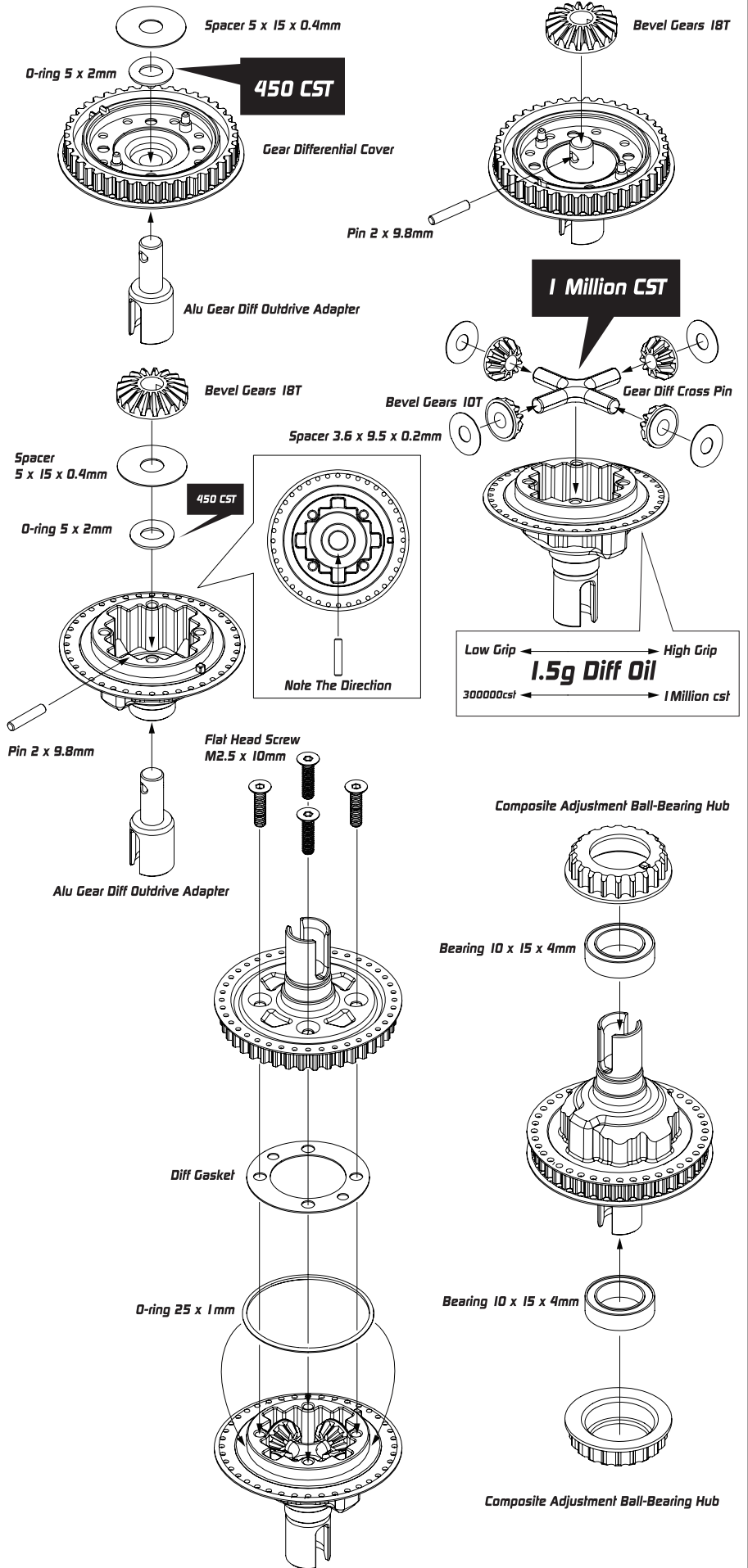

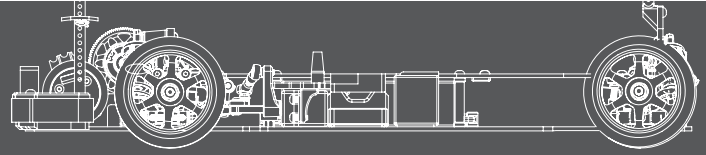

Bag C, Carbon, Screw, Spacer and Bearing Bag

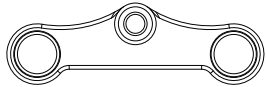

Alu Steering Plate For Dual Servo Saver 4mm
XP-10113

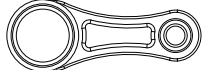

Alu Dual Servo Saver Arm
XP-10111



Bearing 5 x 8 x 2.5mm
XP-40061



Bearing 3 x 6 x 2.5mm
XP-40060



Alu Shim 3 x 6 x 1mm Red
XP-10119



Round Head Screw M3 x 8mm
XP-40038



Bulb Head Screw M3 x 6mm
XP-40037

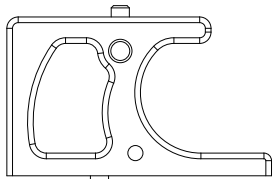

Alu Servo Mount
XP-10136

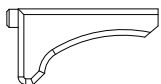

Alu Servo Side Mount
XP-10136



Servo Horn 23T for Sanwa, KO
XP-10163

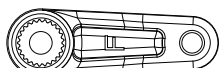

Servo Horn 25T for Futaba
XP-10163

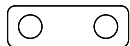

Servo Spacer
XP-10136

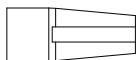

Antenna Holder
XP-10001



Flat Head Screw M3 x 10mm
XP-40049



Flat Head Screw M3 x 6mm
XP-40046



Battery Stopper
XP-10185

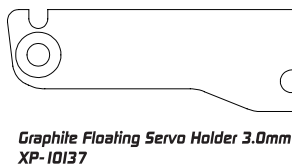

Graphite Floating Servo Holder 3.0mm
XP-10137

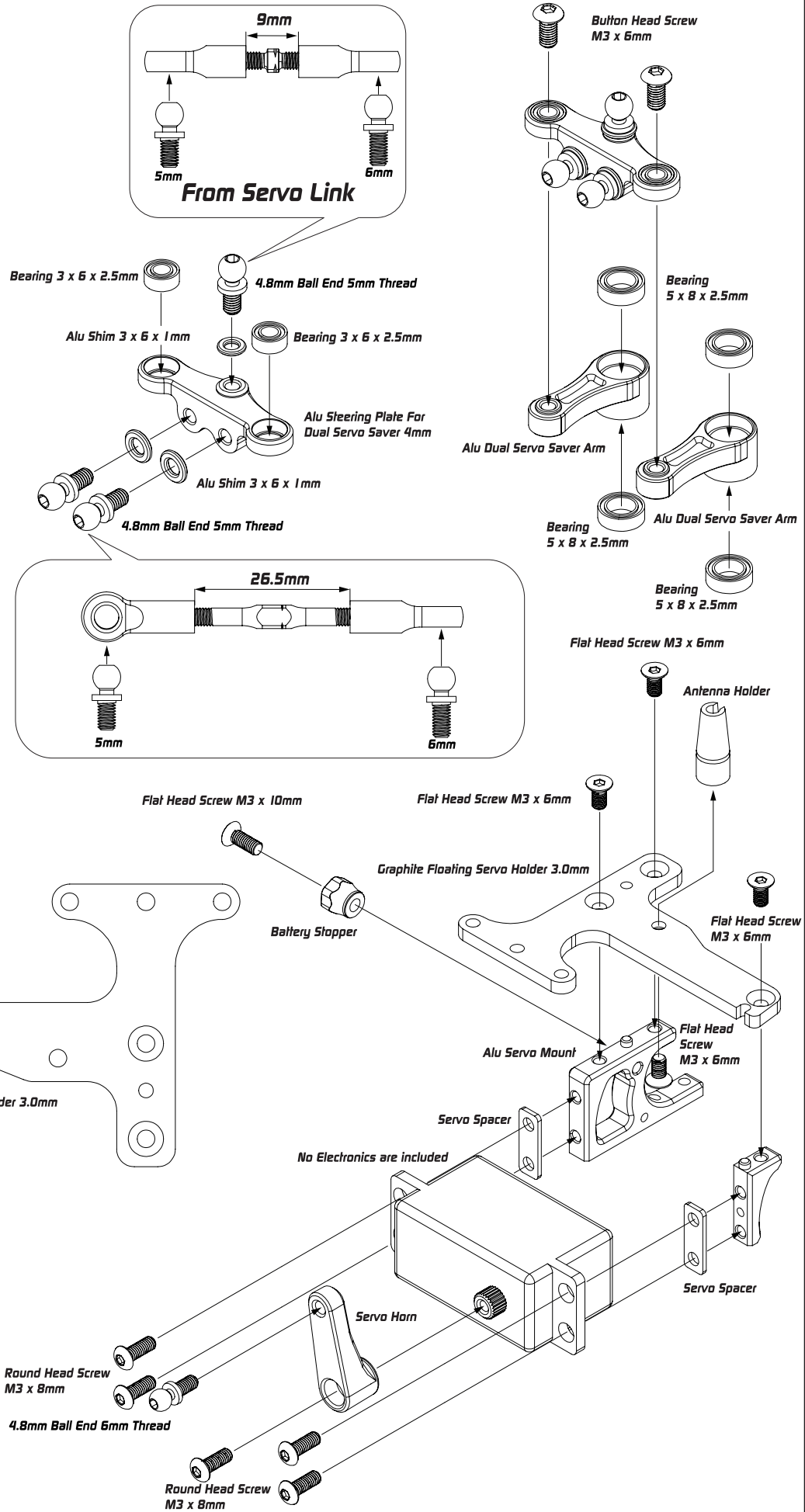

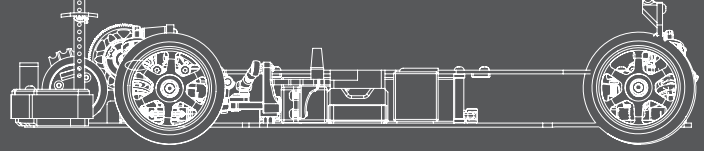

Bag D ,E and Screw Bag

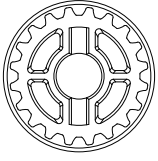

20T Center Pulley
XP-10134

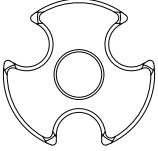

Center Pulley Cover
XP-10134



M5 E-Clip
XP-40058



Pin 2 x 9.8mm
XP-40069

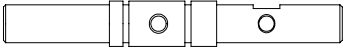

Steel Gearbox Shaft
XP-10431

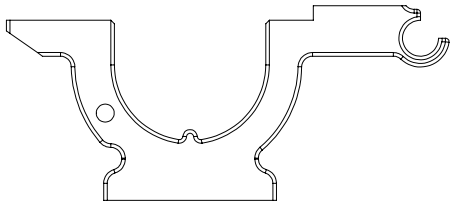

Aluminum Front Bulkhead Left
XP-10423

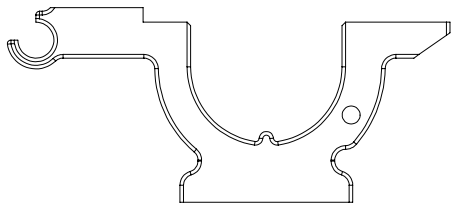

Aluminum Front Bulkhead Right
XP-10424

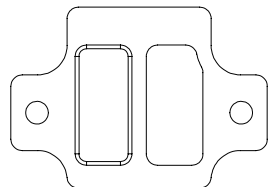

Brass Lower Bulkhead Plate
XP-10432



Flat Head Screw M3 x 6mm
XP-40046

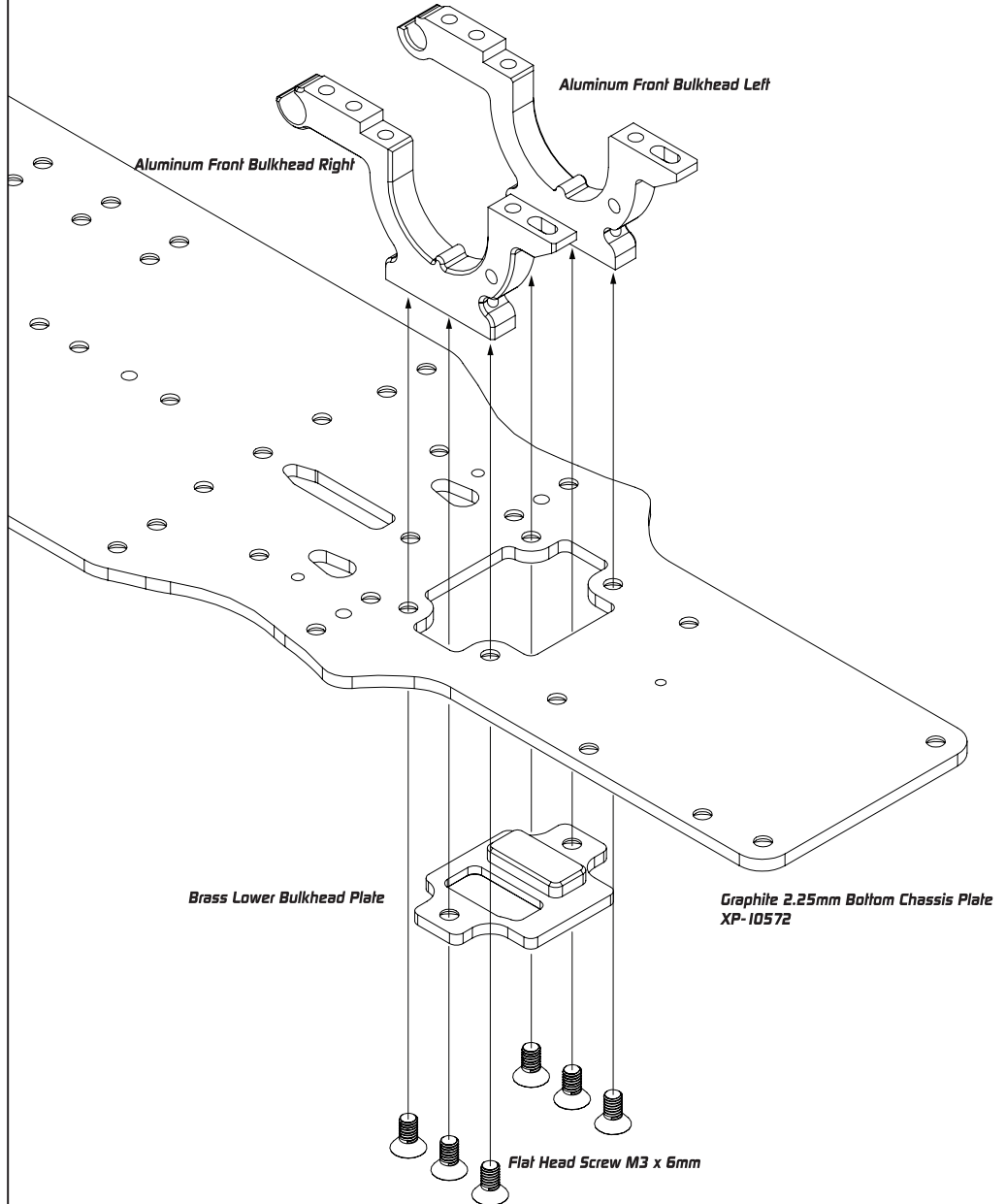
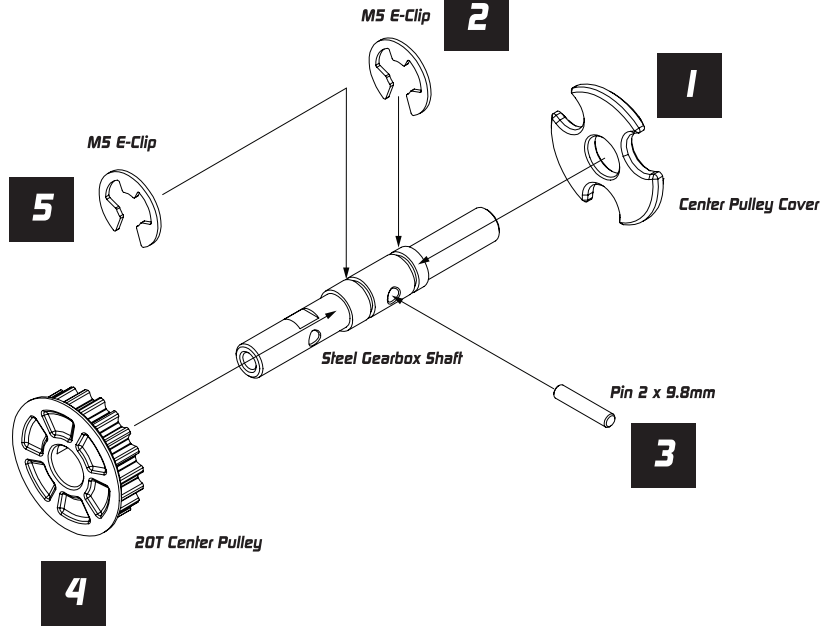

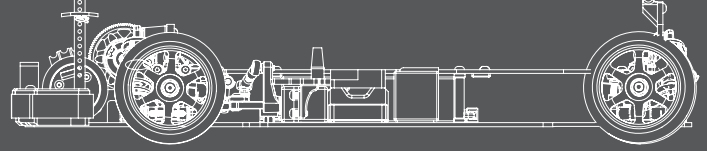

Bag E, Screw, Spacer and Bearing Bag

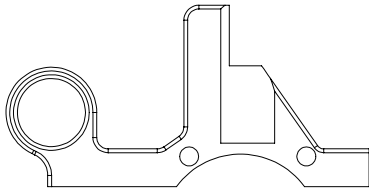

Aluminum Front Upper Clamp Left
XP-10425

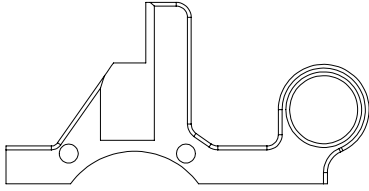

Aluminum Front Upper Clamp Right
XP-10426



Bearing 5 x 10 x 4mm
XP-40064



Alu Shim 3 x 6 x 1mm
XP-10119

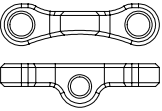

Camberlink Mount Front
XP-10105



Round Head Screw M3 x 8mm
XP-40038

Round Head Screw M3 x 8mm

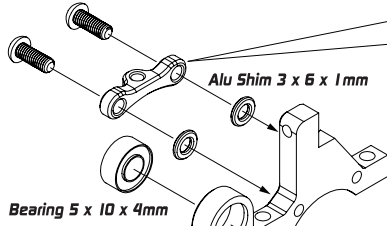

Alu Shim 3 x 6 x 1mm

Bearing 5 x 10 x 4mm

Aluminum Front Upper Clamp Right

Note: Flat surface of the camberlink mount faces upwards

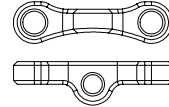

Note: Flat surface of the camberlink mount faces upwards

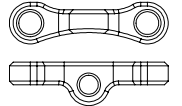

Alu Shim 3 x 6 x 1mm

Aluminum Front Upper Clamp Left

Bearing 5 x 10 x 4mm



Round Head Screw M3 x 8mm

Round Head Screw M3 x 8mm

Round Head Screw M3 x 8mm

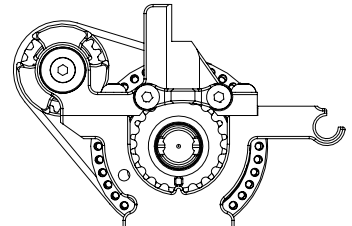
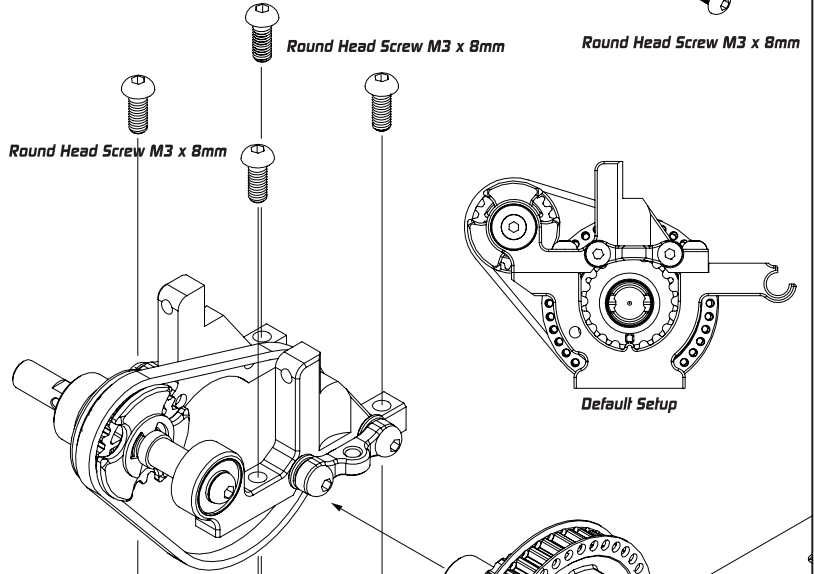

Default Setup

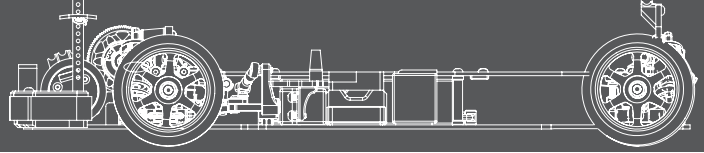

Bag F , Screw , Spacer

 **Alu Shim 3 x 6 x 1mm**
XP-10119

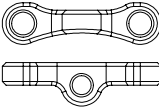
 **Camberlink Mount Front**
XP-10105

 **Round Head Screw M3 x 8mm**
XP-40038

 **Flat Head Screw M3 x 6mm**
XP-40046

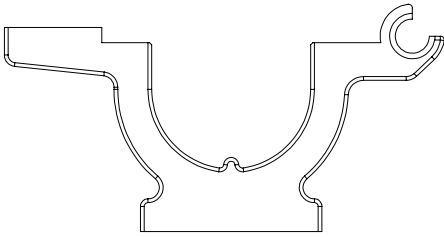

Separate Bulkhead Type A
XP-10588

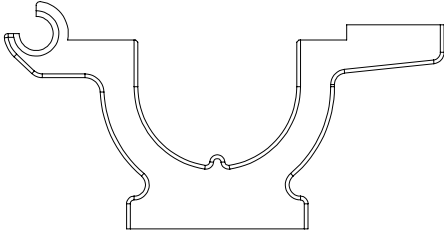

Separate Bulkhead Type B
XP-10589

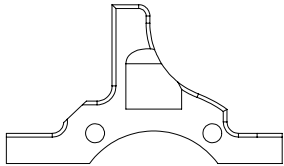

Separate Upper Bulkhead RR
XP-10590

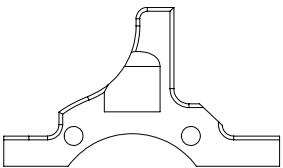

Separate Upper Bulkhead RL
XP-10591

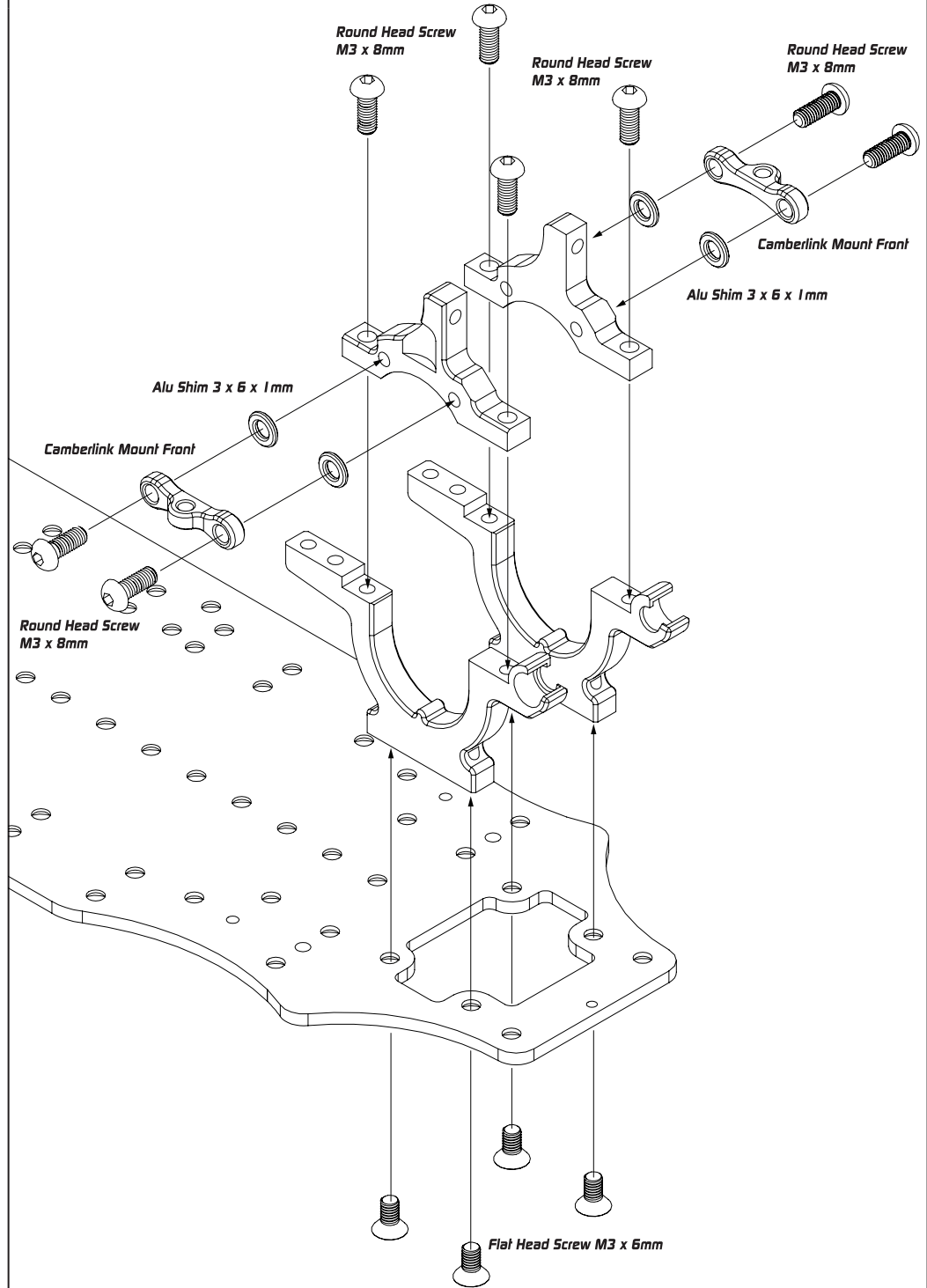

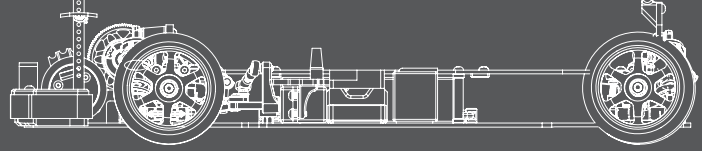

Bag G and Screw Bag



Alu Steering Post For Dual Servo Saver 11.5mm
XP-10494

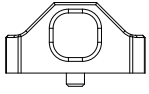

Alu Lower 2-Piece Suspension Holder
XP-10123

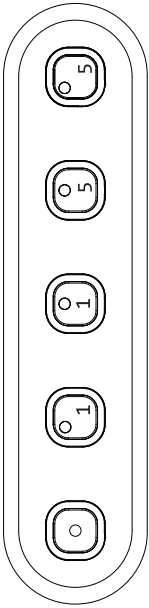

Eccentric Bushing Set
XP-10127



Flat Head Screw M3 x 6mm
XP-40046



Button Head Screw M3 x 6mm
XP-40037

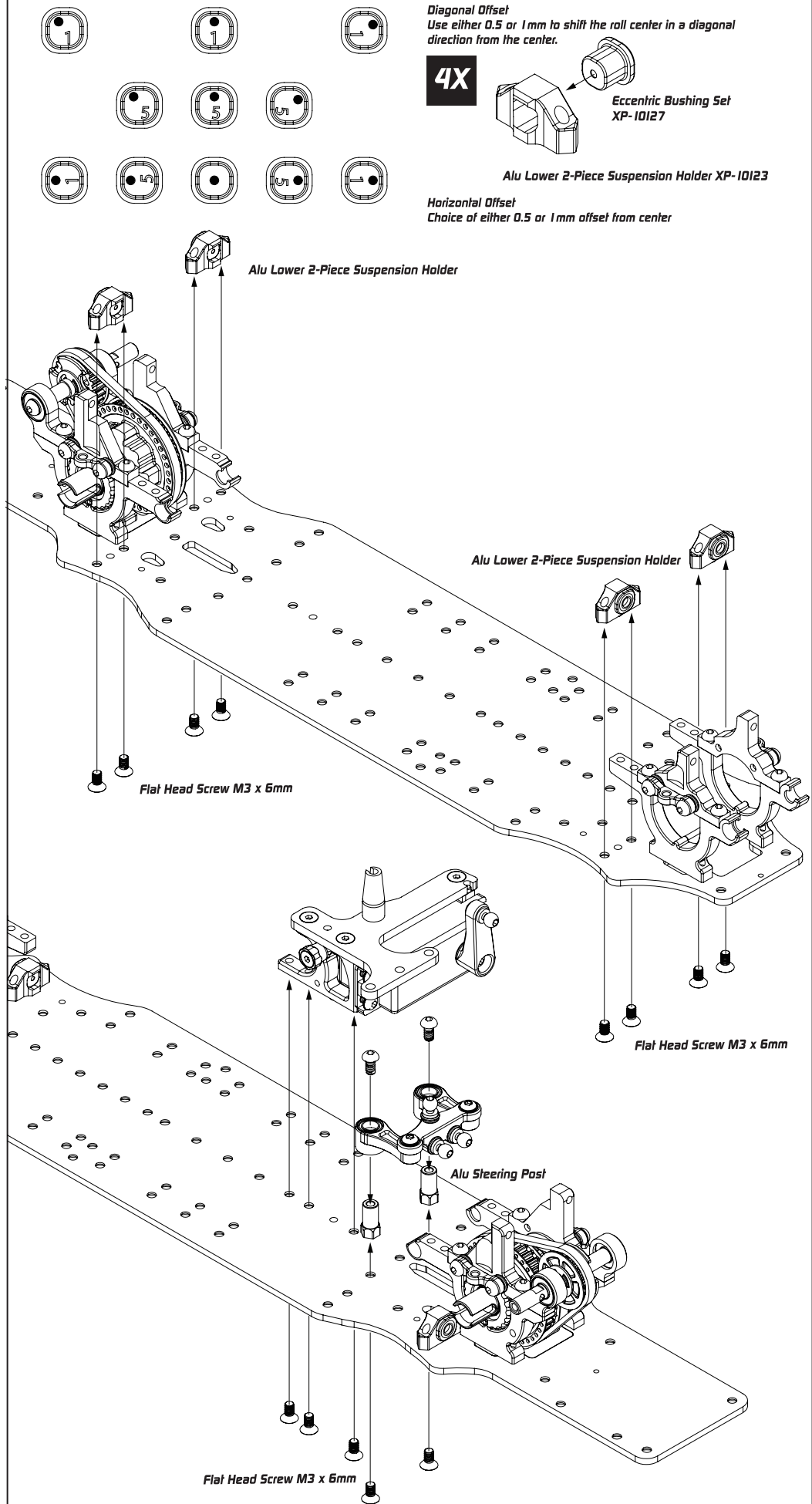

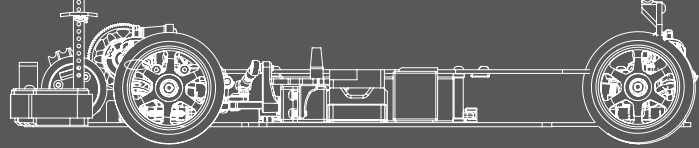

Bag E , Bag Carbon and Screw



Button Head Screw M3 x 6mm
XP-40037



Button Head Screw M3 x 4mm
XP-40036



Flat Head Screw M3 x 6mm
XP-40046

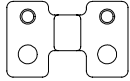

Upper Deck Stiffener
XP-10566



Chassis Stiffener Post
XP-10617

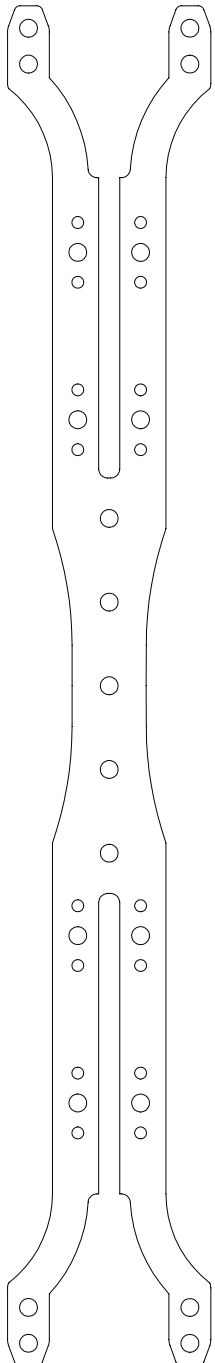

Graphite 2mm TopDeck
XP-10592

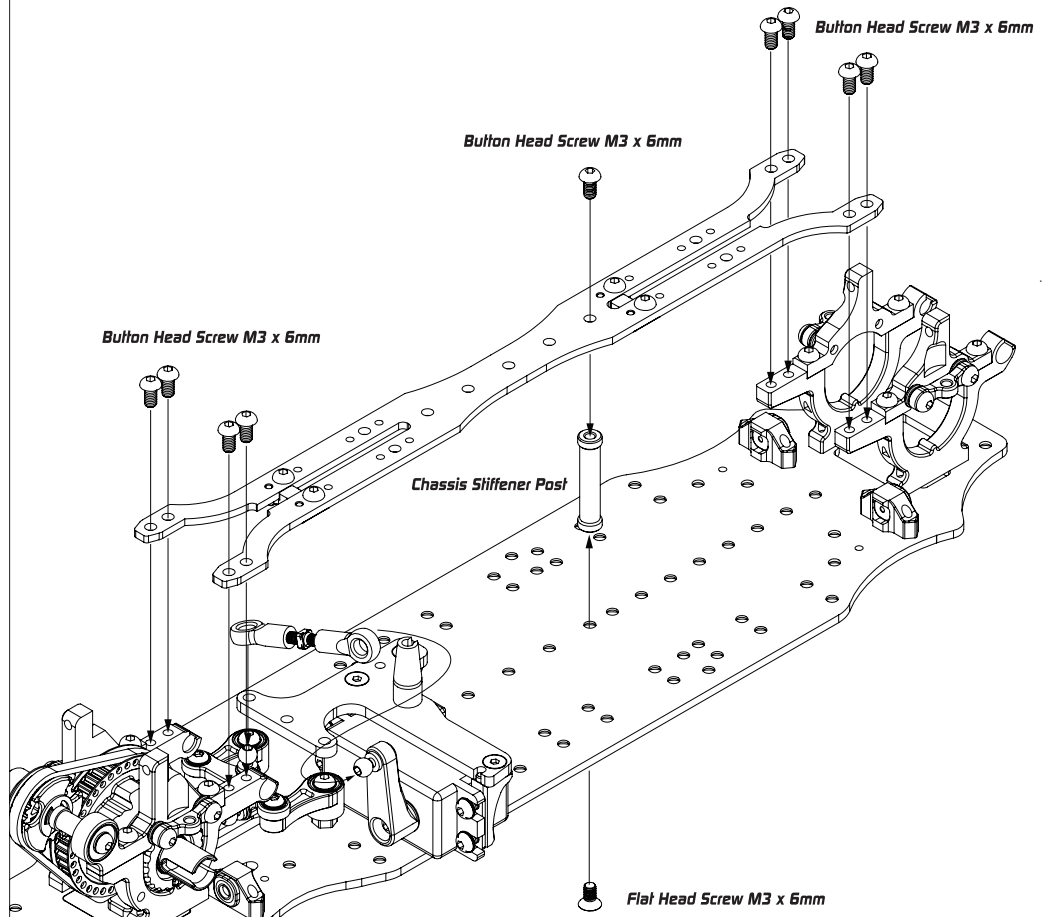
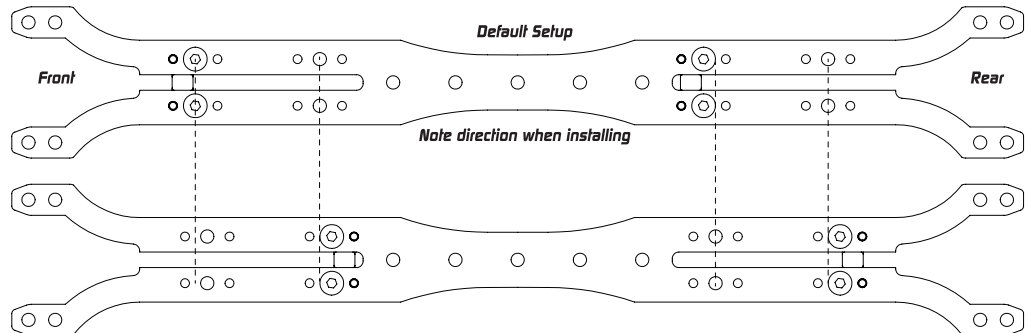
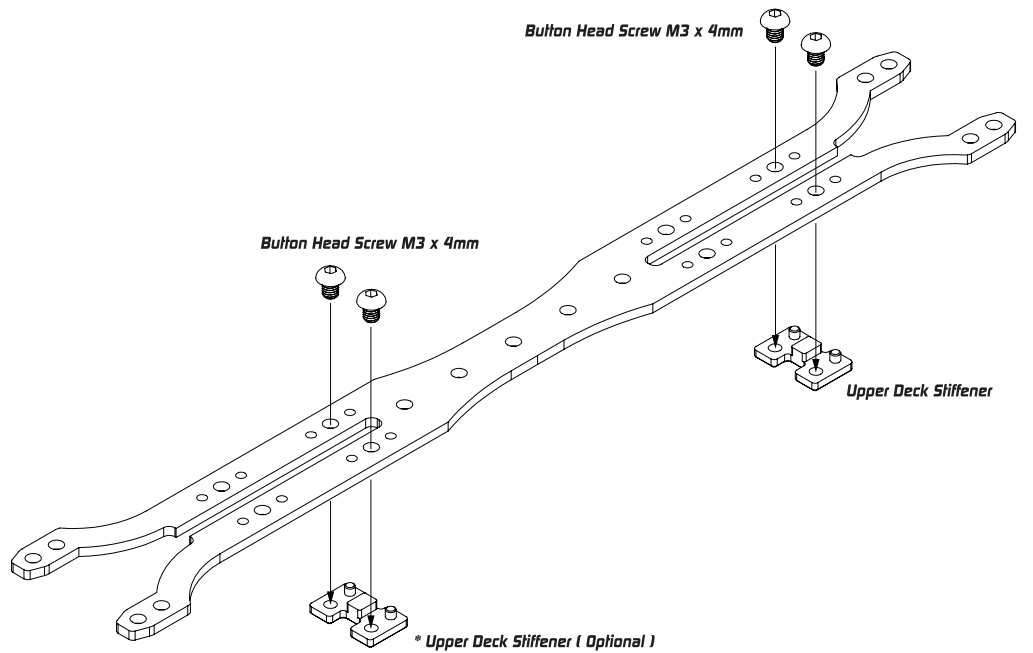

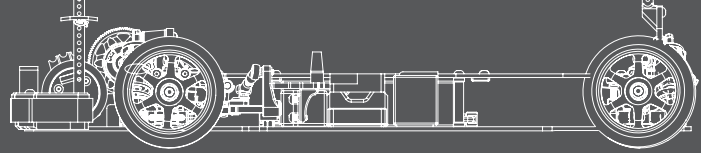

Bag H , Bag Bearing and Screw Bag

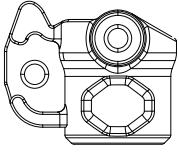

Composite Steering Block Right
XP-10109 Optional XP-10247

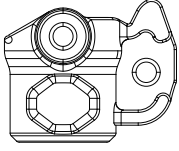

Composite Steering Block Left
XP-10109 Optional XP-10247

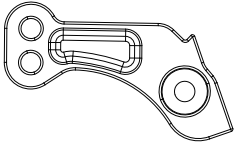

Composite Steering Block Plate Right
XP-10109 Optional XP-10247

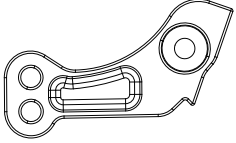

Composite Steering Block Plate Left
XP-10109 Optional XP-10247



Bearing 5 x 10 x 3mm
XP-40063



Bearing 5 x 10 x 4mm
XP-40064

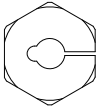

Alu Wheel Hub Red
XP-10129



Pin 2 x 9.8mm
XP-40069



Round Head Screw M3 x 8mm
XP-40038



Cap Head Screw M1.6 x 4mm
XP-10129



Hex Set Screw M3 x 2mm
XP-40051



5 x 7 x 0.1mm Spacer
XP-40017

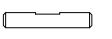

Steel 2 x 12mm Flatspot Pin for Universal
XP-40071



Driveshaft Protector Blade
XP-10128

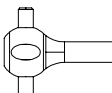

39.3mm Spring Steel Double Joint Universal Shaft 2pcs
XP-10334

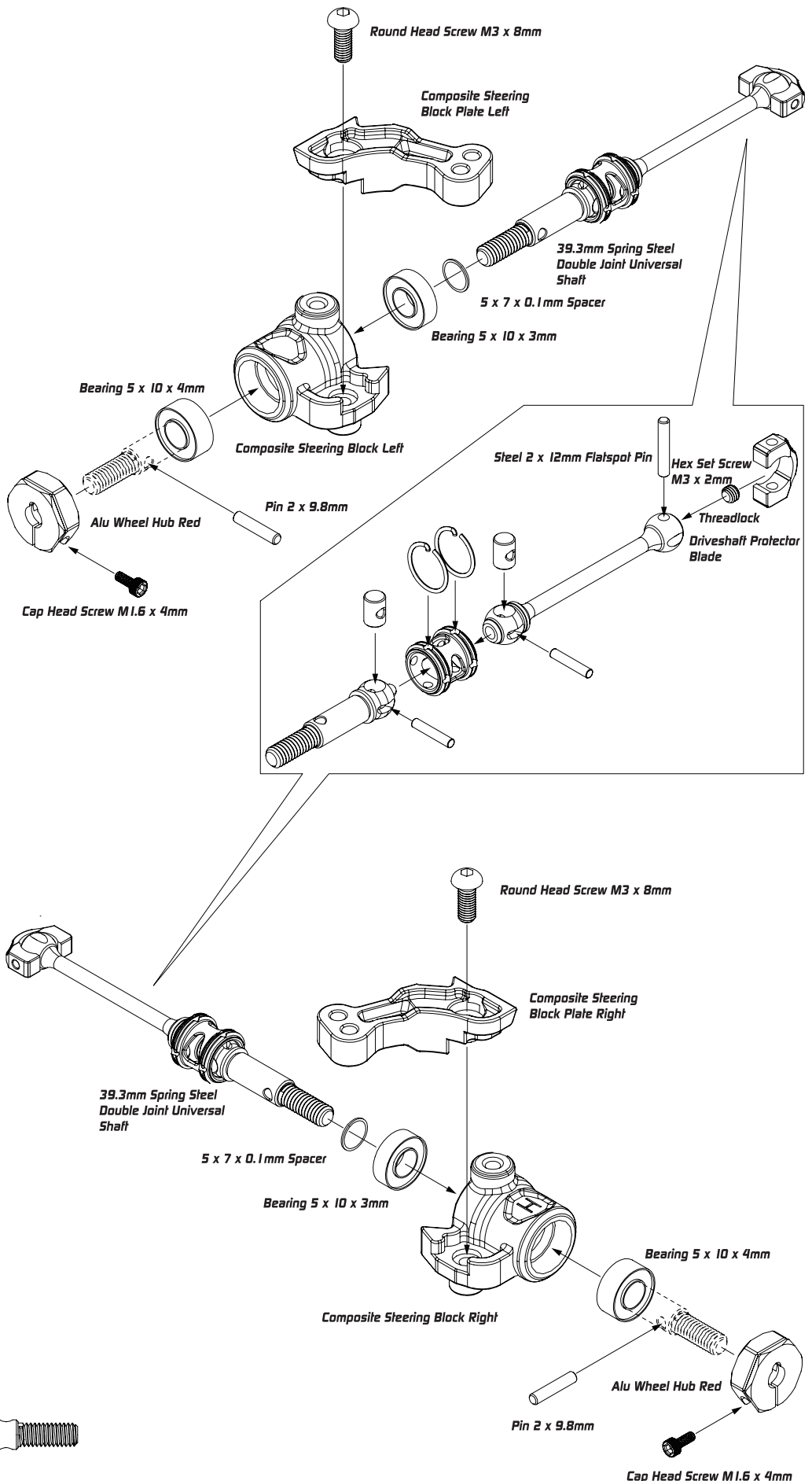

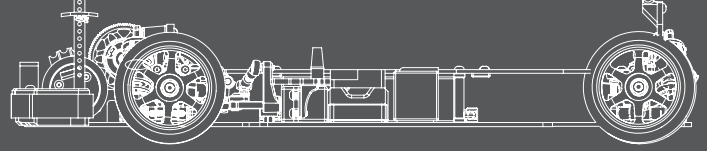

Bag H, Spacer and Bag Screw

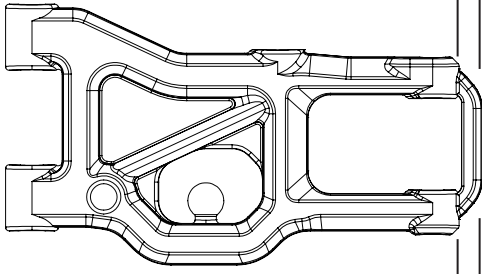

Front Composite Suspension Arm (Strong)
XP-10603 Optional XP-10597

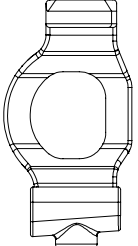

Composite C Hub 4 Degree L (Strong)
XP-10604 Optional XP-10598

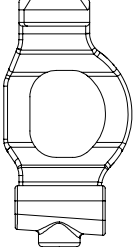

Composite C Hub 4 Degree R (Strong)
XP-10604 Optional XP-10598



Suspension Pivot Pin 3 x 42mm
XP-10139

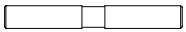

3mm Outer Suspension Pin w/ Groove
XP-10602



Alu Shim 3 x 6 x 1mm
XP-10119



Set Screw M3 x 3mm
XP-40052



Hex Set Screw M4 x 10mm
XP-40056



Hex Set Screw M3 x 8mm
XP-40054

Composite C Hub 4 Degree R (Strong)

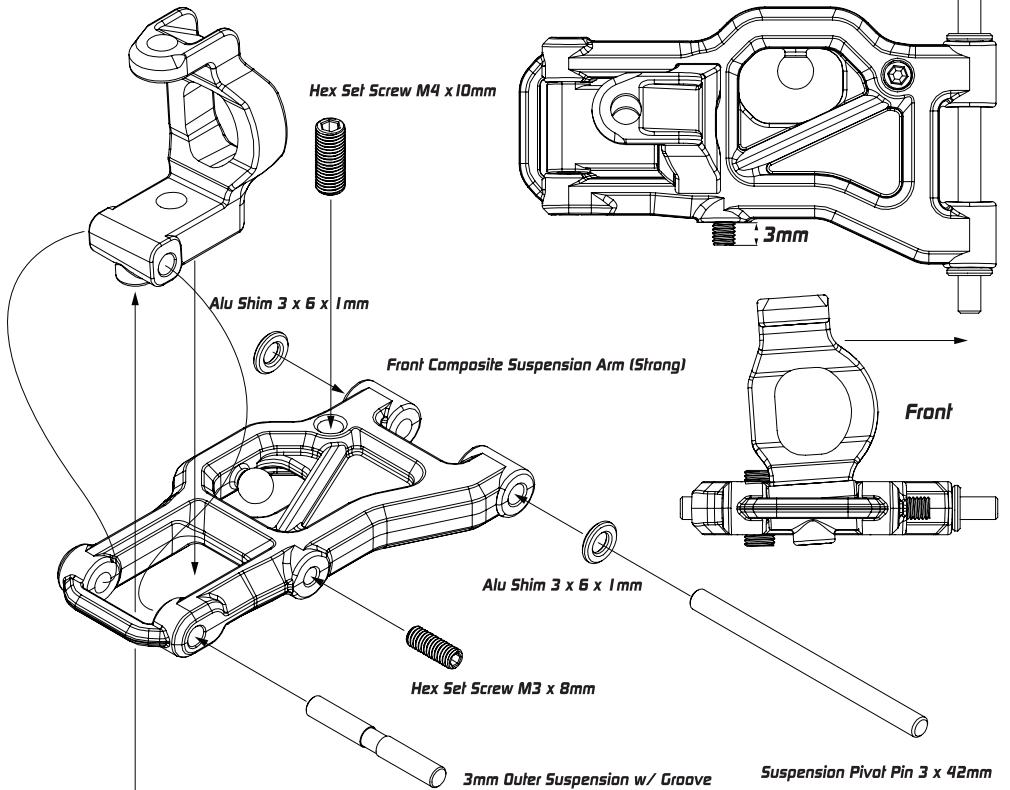

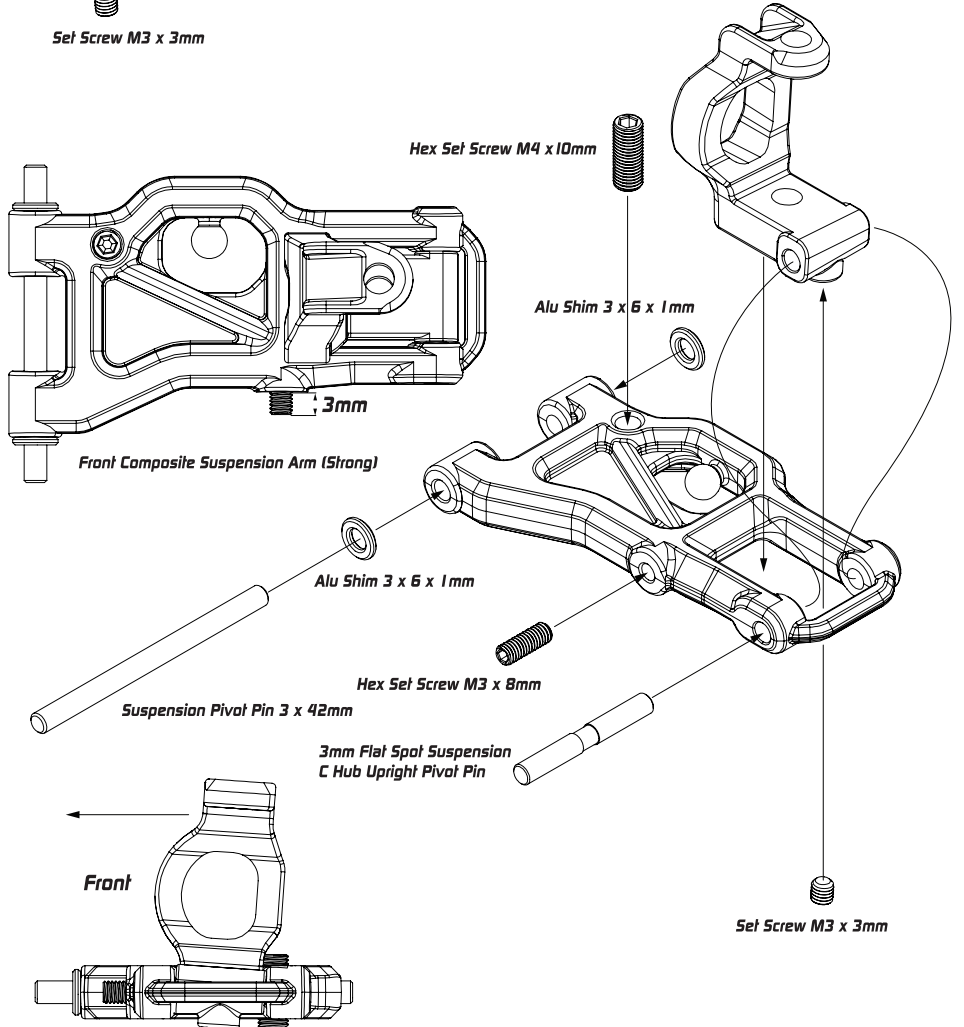

Composite C Hub 4 Degree L (Strong)

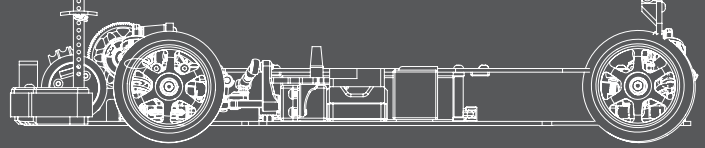



Bag H and Bag Spacer

-  King Pin Collar
XP-10164
-  Alu Shim 3 x 6 x 1 mm
XP-10119
-  King Pin
XP-10164

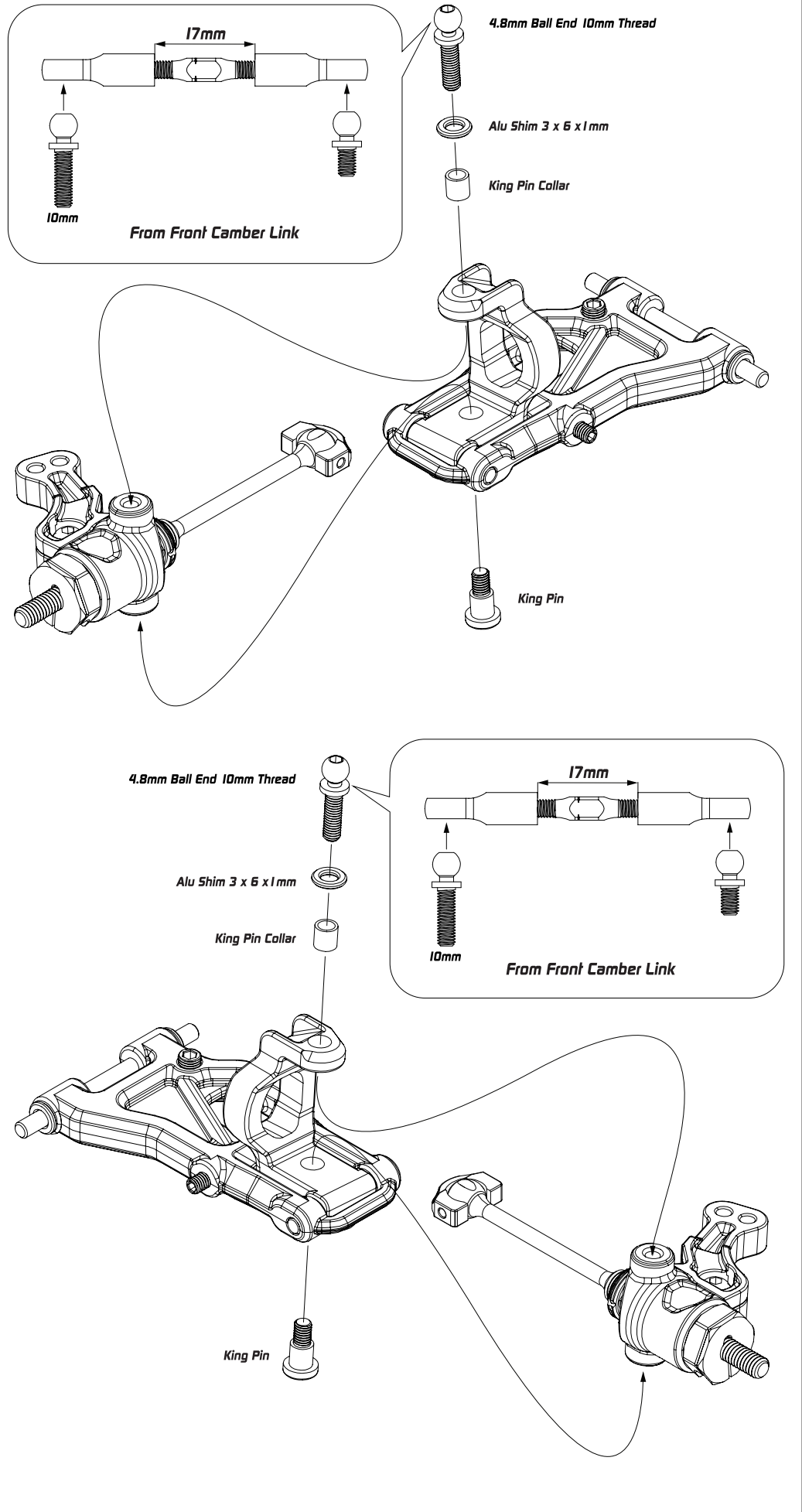

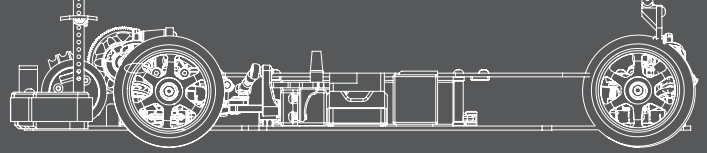

Bag D , H , Spacer and Screw Bag

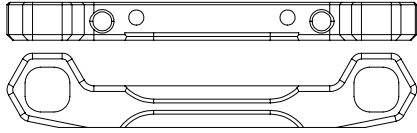

Alu Front Lower I-Piece Suspension Holder – FF
XP-10114



Alu Shim 3 x 6 x 1mm
XP-10119



Flat Head Screw M3 x 6mm
XP-40046

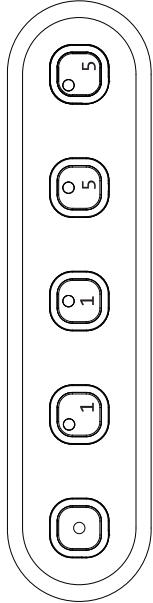

Eccentric Bushing Set
XP-10127

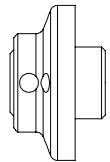

Spur Gear Adaptor
XP-10567

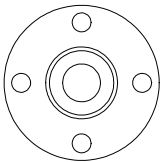

Button Head Screw M3 x 6mm
XP-40037



Set Screw M3 x 3mm
XP-40052



Pin 2 x 9.8mm
XP-40069

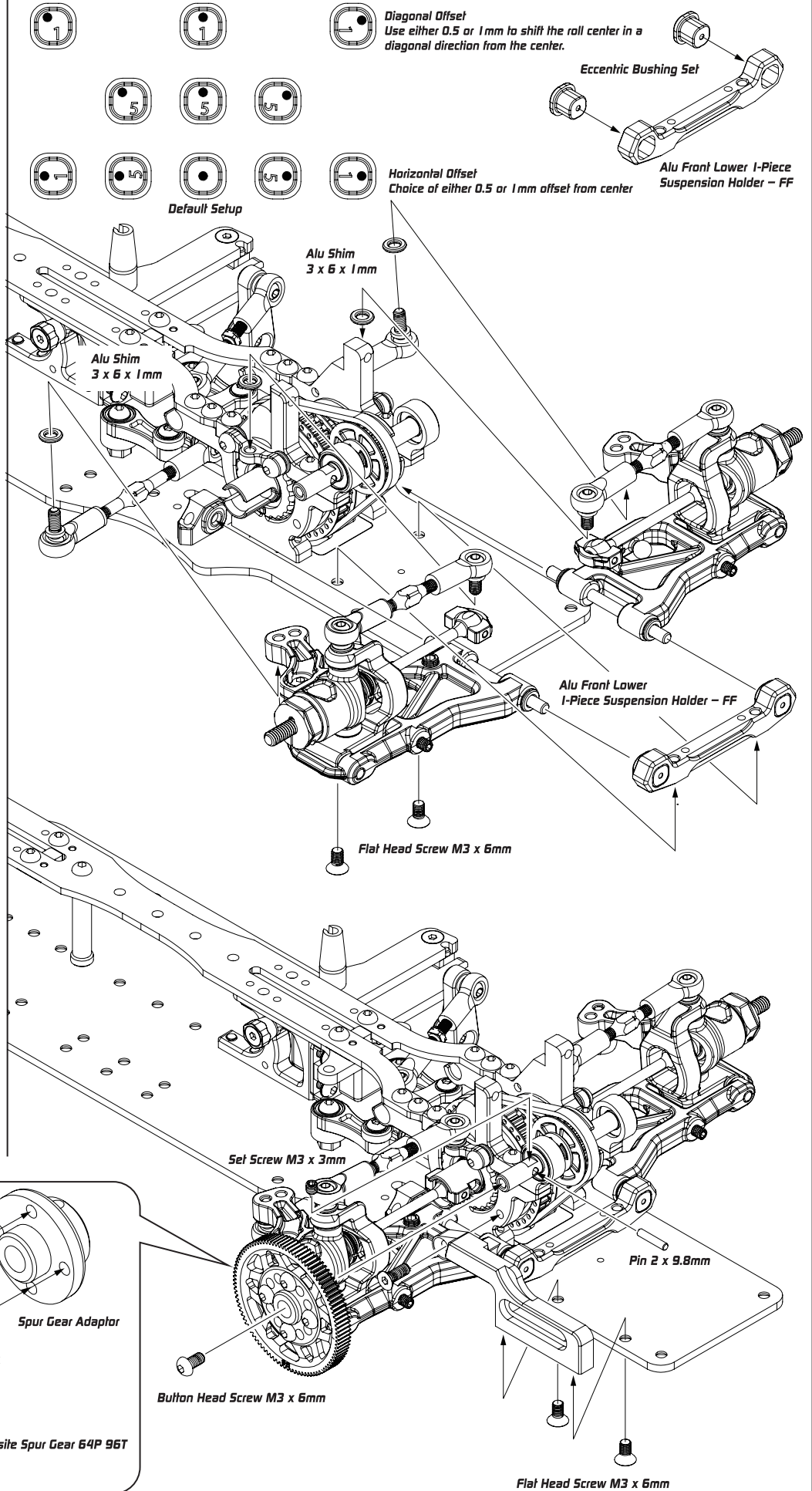
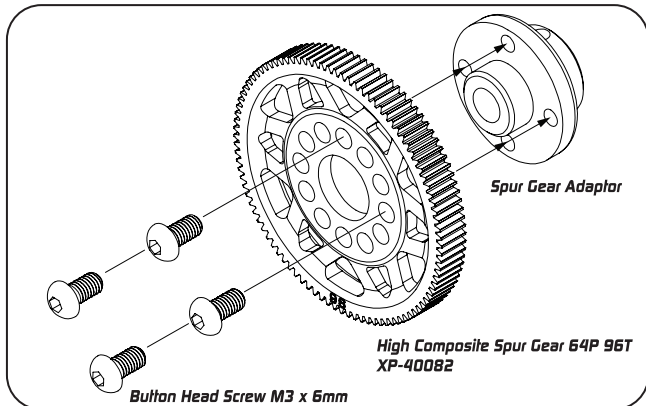

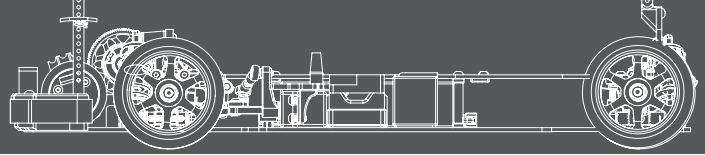

Bag 1, Spacer, Bearing and Screw

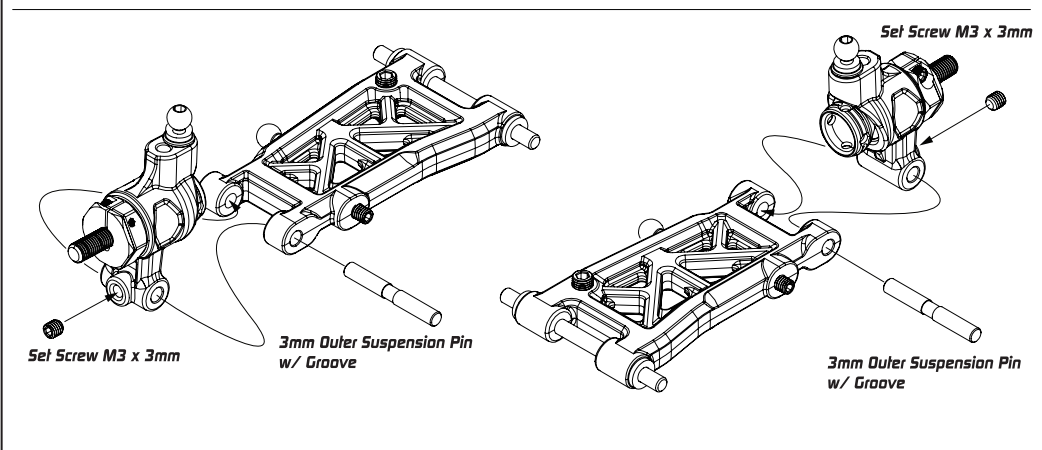
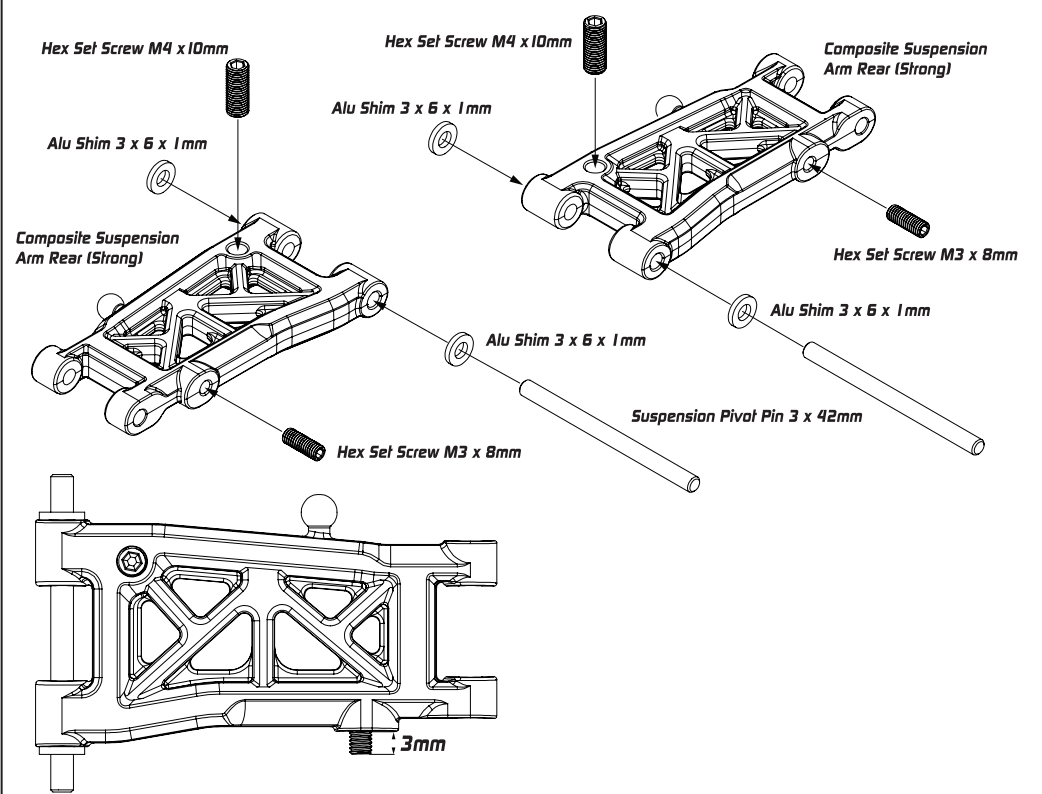
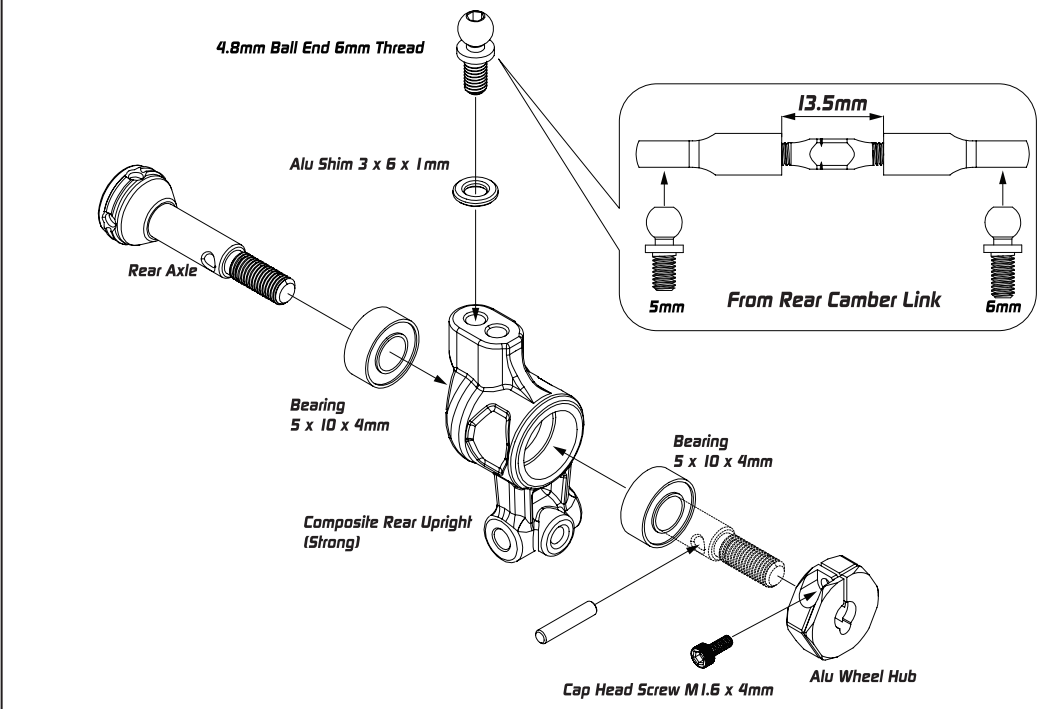
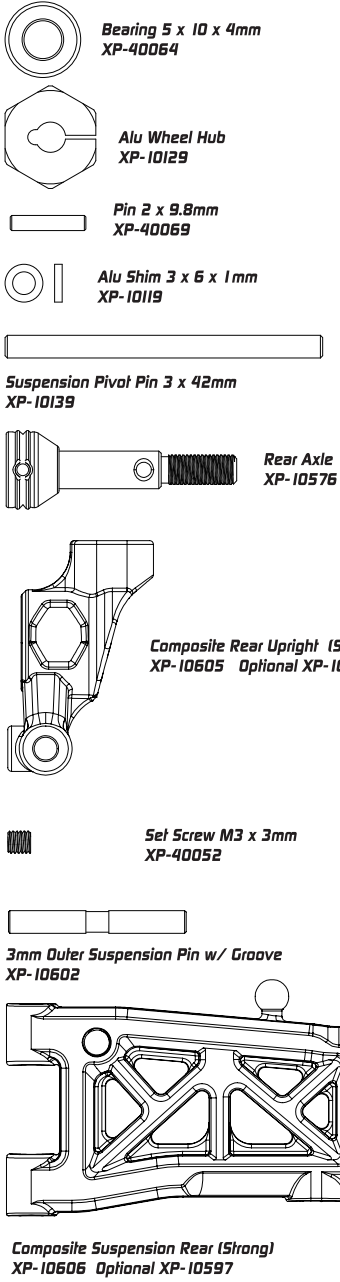

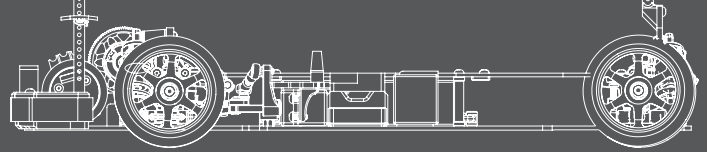

Bag 1, Spacer and Screw Bag

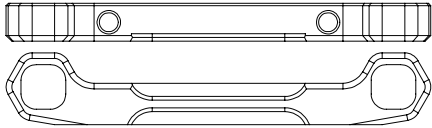

Alu Rear Lower I-Piece Suspension holder - RR
XP-10124



Flat Head Screw M3 x 6mm
XP-40046

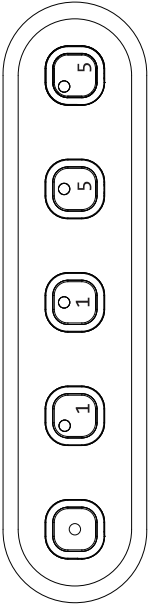

Eccentric Bushing Set
XP-10127



Alu Shim 3 x 6 x 1mm
XP-10119



Diagonal Offset
Use either 0.5 or 1mm to shift the roll center in a diagonal direction from the center.



Alu Rear Lower I-Piece
Suspension holder - RR

Eccentric Bushing Set



Horizontal Offset
Choice of either 0.5 or 1mm offset from center

Default Setup

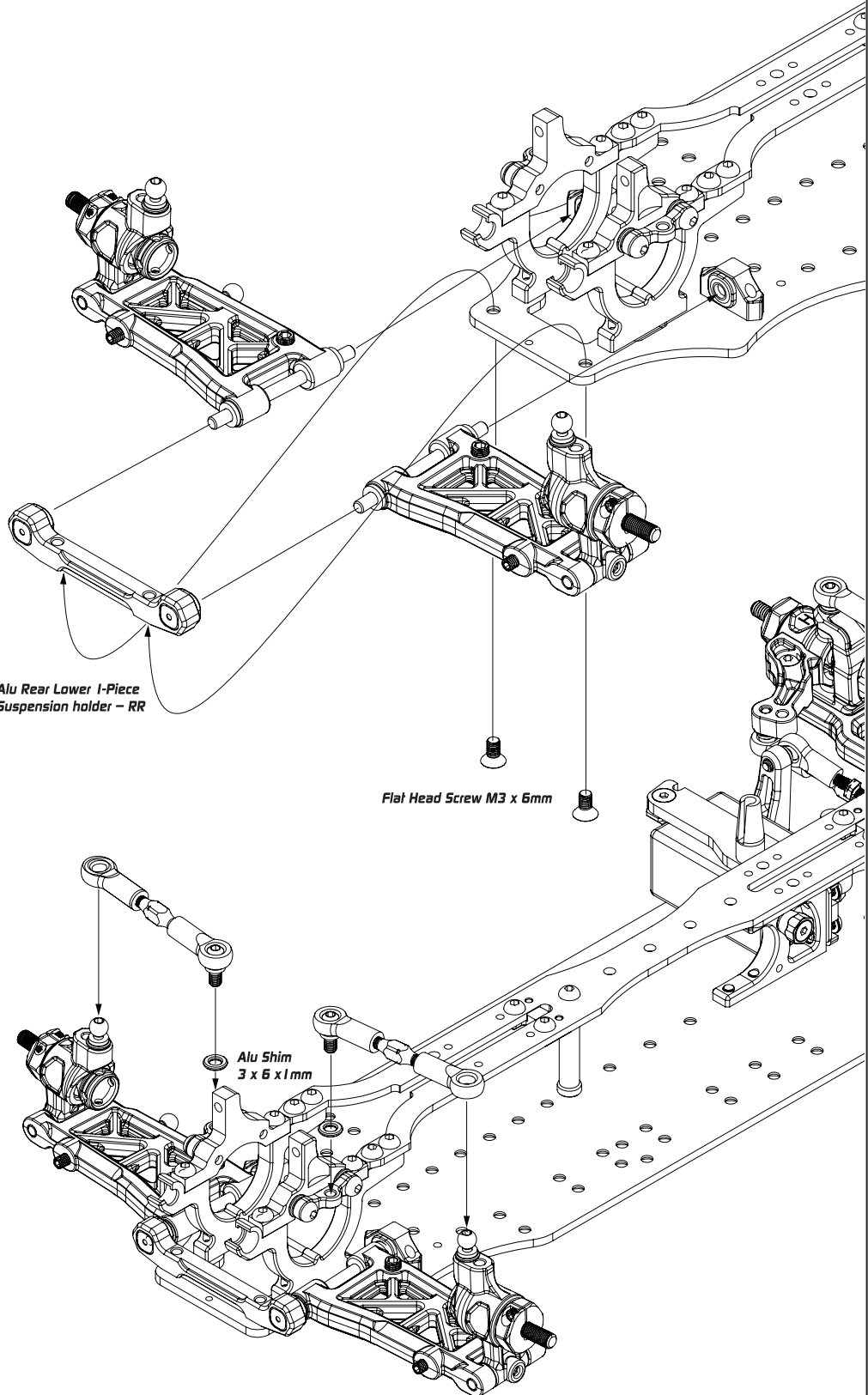

Alu Rear Lower I-Piece
Suspension holder - RR

Flat Head Screw M3 x 6mm

Alu Shim
3 x 6 x 1mm

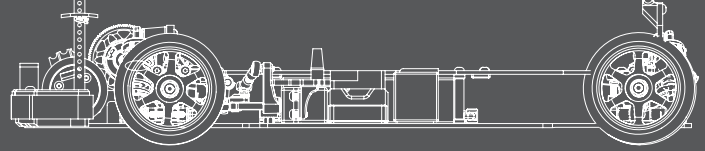

Front

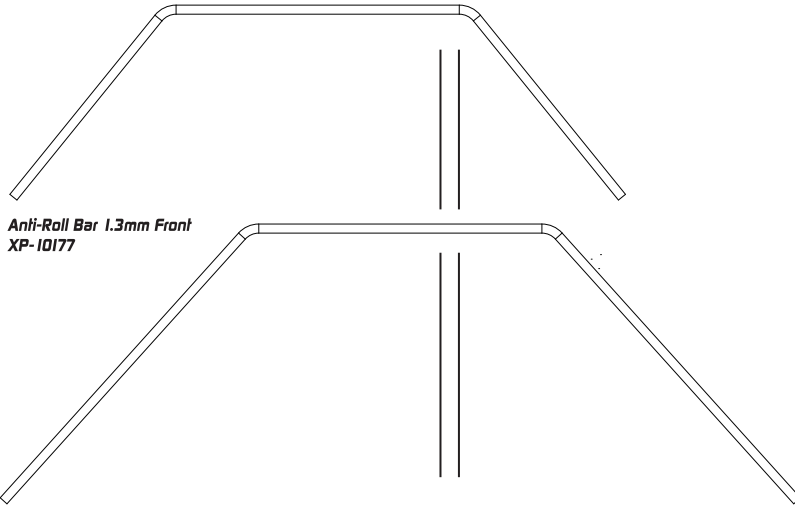

Anti-Roll Bar 1.3mm Front
XP-10177

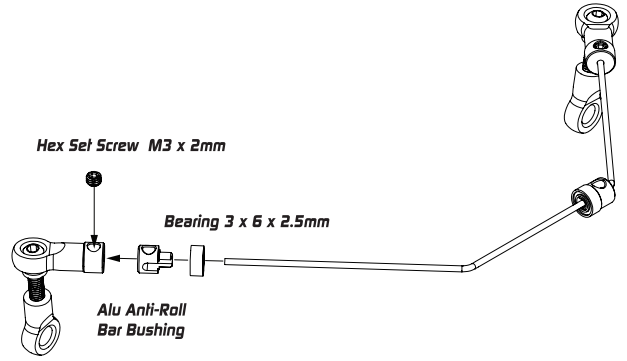

Hex Set Screw M3 x 2mm

Bearing 3 x 6 x 2.5mm

Alu Anti-Roll
Bar Bushing

Rear

Anti-Roll Bar 1.2mm Rear
XP-10176

Hex Set Screw M3 x 2mm

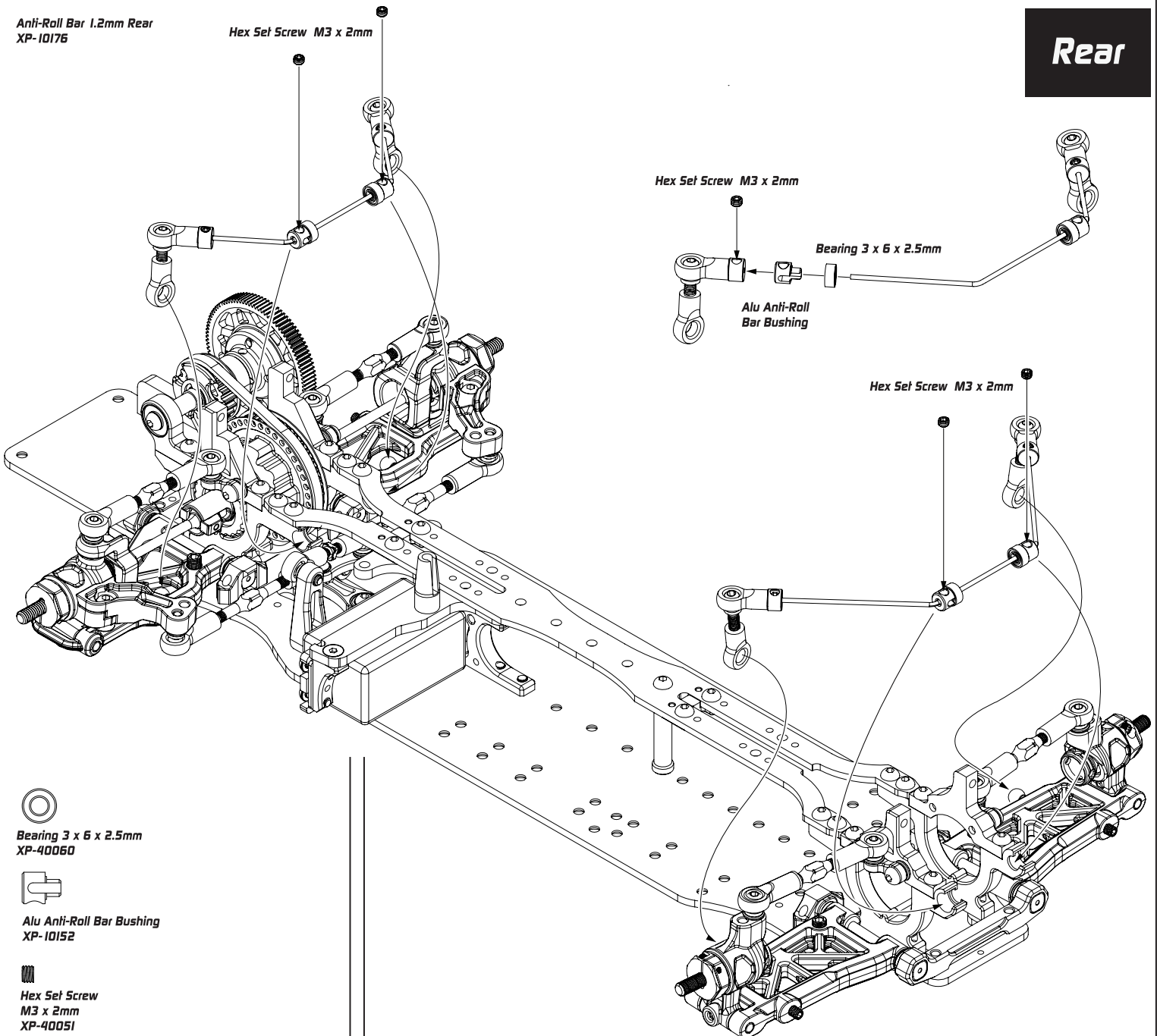

Hex Set Screw M3 x 2mm

Bearing 3 x 6 x 2.5mm

Alu Anti-Roll
Bar Bushing

Hex Set Screw M3 x 2mm



Bearing 3 x 6 x 2.5mm
XP-40060



Alu Anti-Roll Bar Bushing
XP-10152



Hex Set Screw
M3 x 2mm
XP-40051

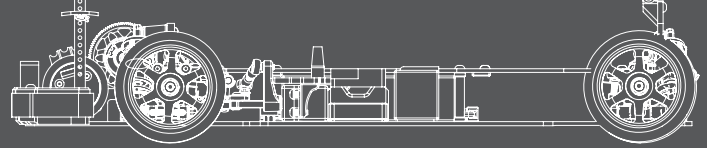

Bag K and Oil Bag

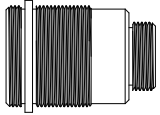

Alu Shock Body
XP-10142

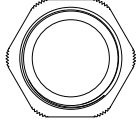

Alu Upper Shock Cap
XP-10146

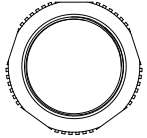

Alu Spring Tension Adjust Nut
XP-10161



Alu Lower Shock Cap
XP-10145

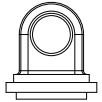

Shock Top Connector v



4 Hole Piston
XP-10159

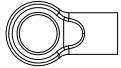

Shock Lower Connector
XP-10144



Shaft Cover
XP-10159



Shaft Spacer
XP-10159

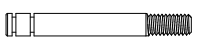

Shock Shaft
XP-10143



Shock Absorber Membrane
XP-10147

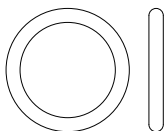

Silicone O Ring For Spring Adjust Nut
XP-10162



Shock O-Ring
XP-10160



E-Clip 2.5mm
XP-40057

Silicone O Ring For Spring Adjust Nut



Alu Spring Tension Adjust Nut

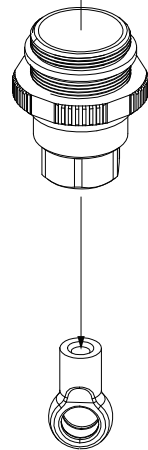
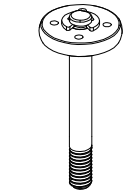
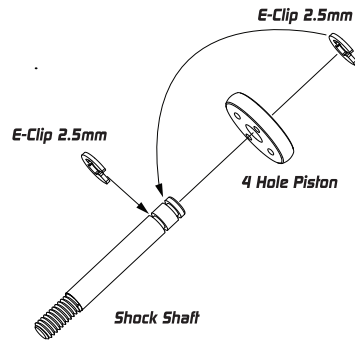

Shock Lower Connector

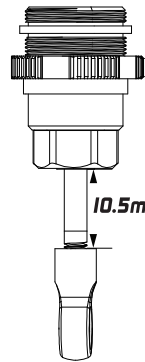
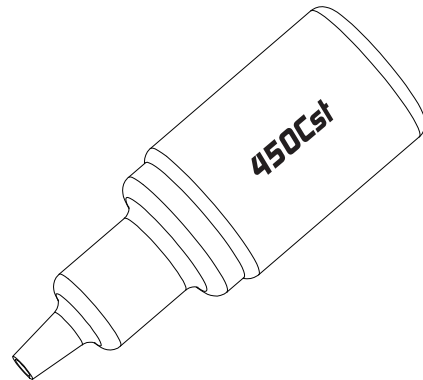

10.5mm

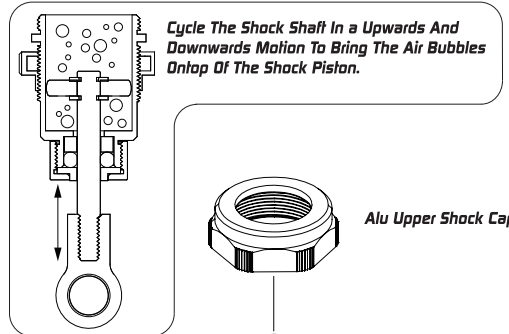

Cycle The Shock Shaft In a Upwards And Downwards Motion To Bring The Air Bubbles Ontop Of The Shock Piston.

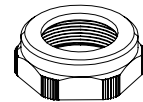

Alu Upper Shock Cap

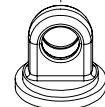

Shock Top Connector

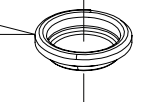

Shock Absorber Membrane

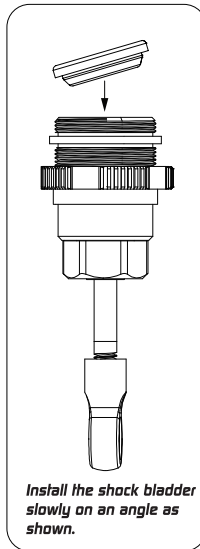
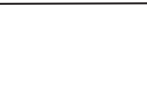
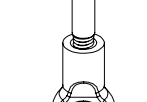
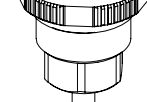
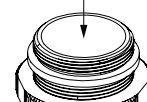

Install the shock bladder slowly on an angle as shown.

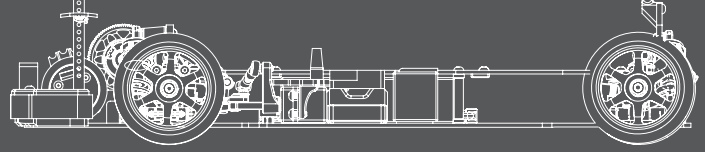

Bag K, L, Carbon and Screw

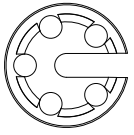

Spring Retainer
XP-10144



Pivot Ball 5.8 mm
XP-10121

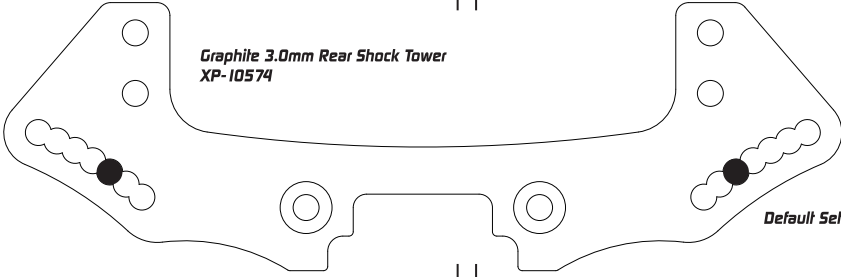

Graphite 3.0mm Rear Shock Tower
XP-10574

Default Setup

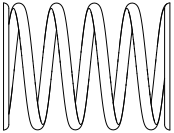

Shock Spring Stiff Pink
XP-10170

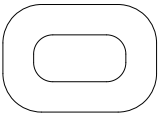

Body Height Adjuster Support
XP-10001

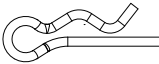

Body Clip
XP-10055



Flat Head Screw M3 x 8mm
XP-40048



Button Head Screw M3 x 6mm
XP-40037

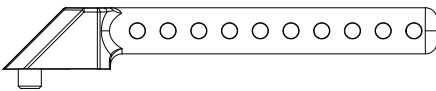

Rear Body Post
XP-10001

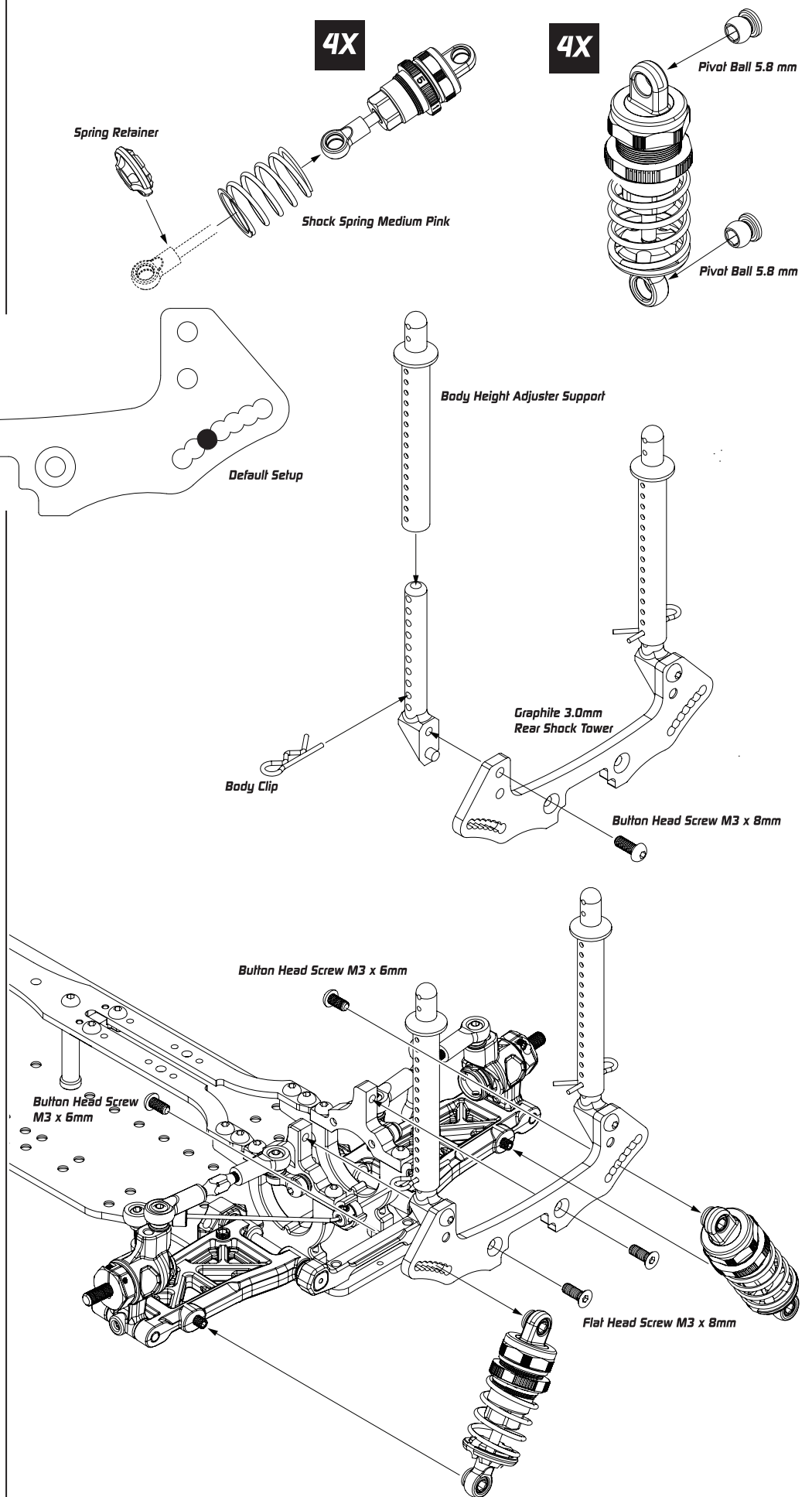

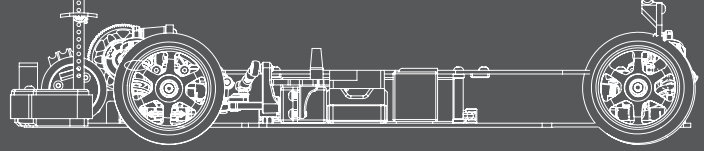

Bag L, Carbon and Screw

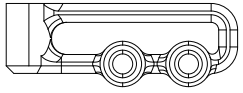

Composite Lipo Battery Backstop
XP-10180



Flat Head Screw M3 x 8mm
XP-40048



Button Head Screw M3 x 6mm
XP-40037



Flat Head Screw M3 x 6mm
XP-40046

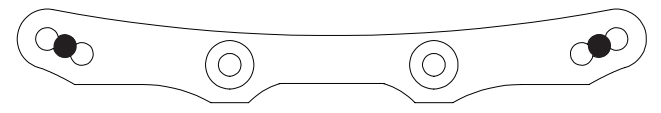
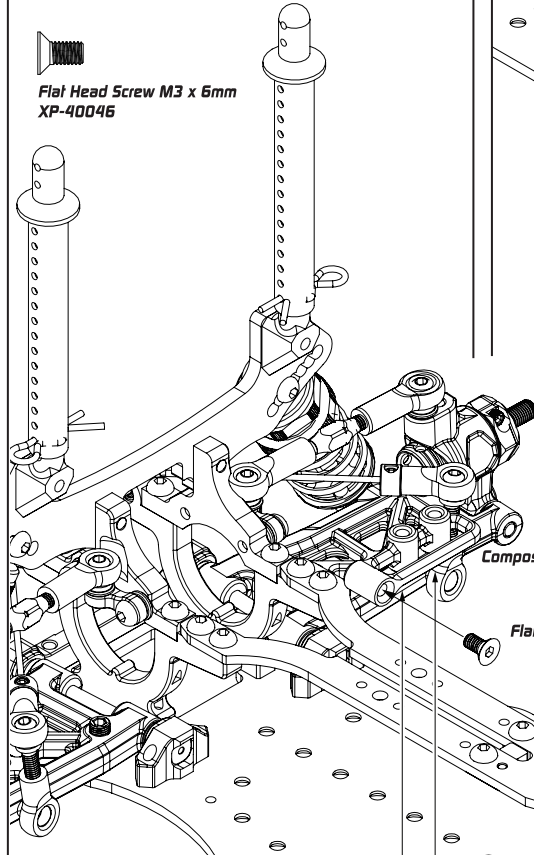
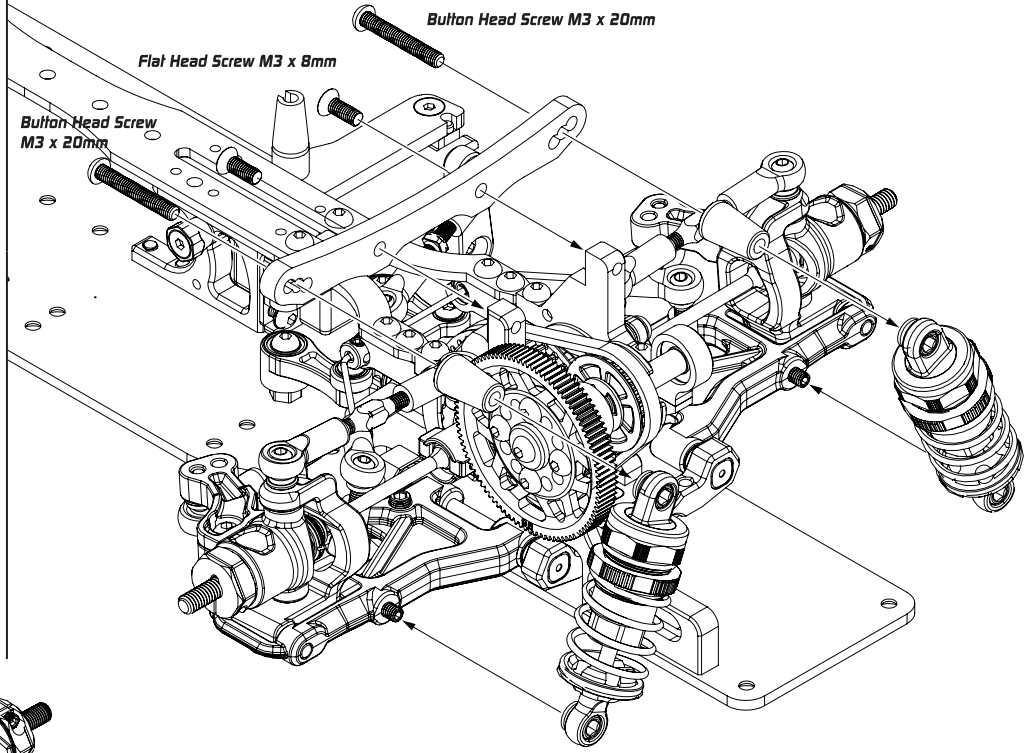

Graphite 4mm Front Shock Tower
XP-10573

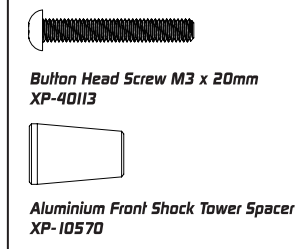

Button Head Screw M3 x 20mm
XP-40113

Aluminium Front Shock Tower Spacer
XP-10570

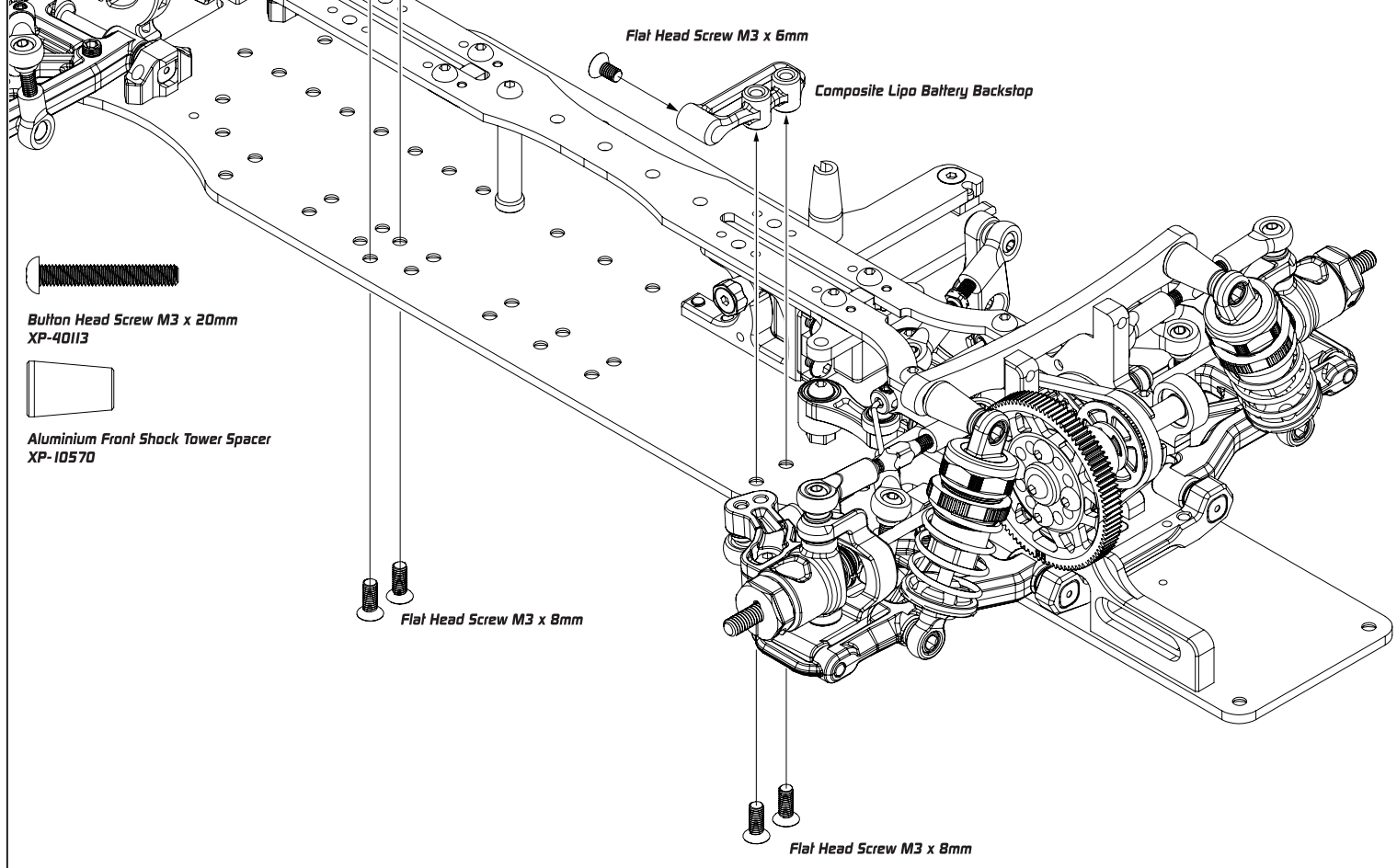

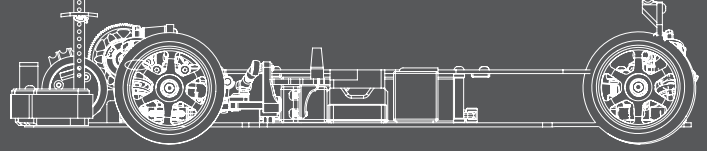

Bag L and Screw Bag



Flat Head Screw M3 x 8mm
XP-40048

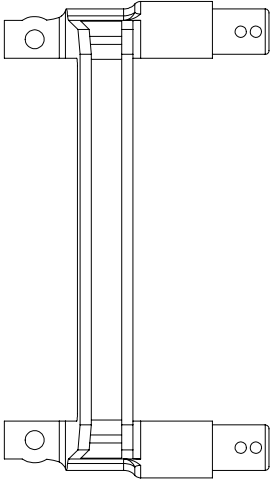

Battery Mount
XP-10005

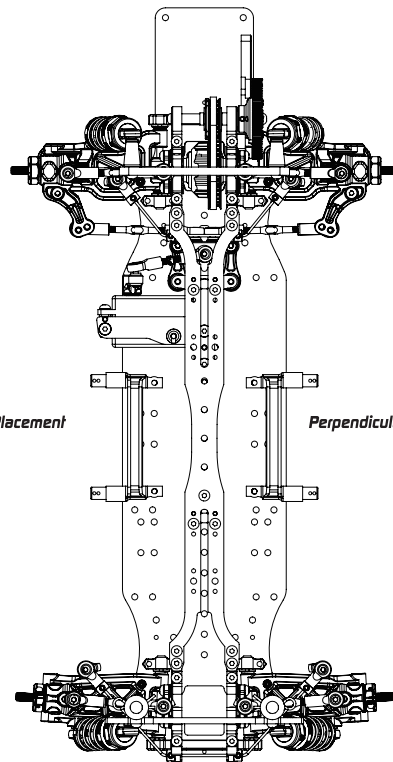
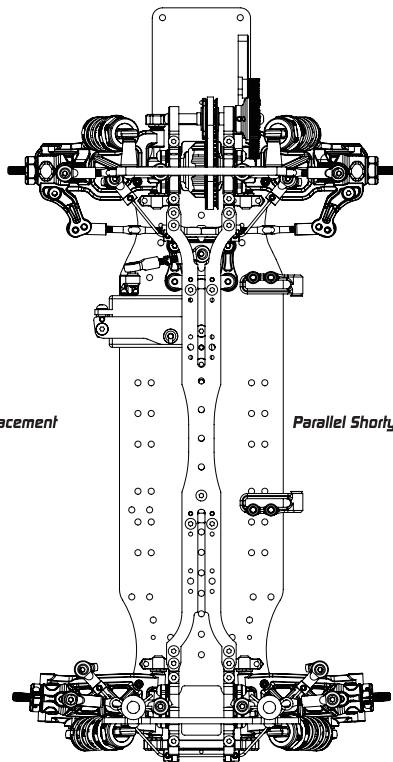
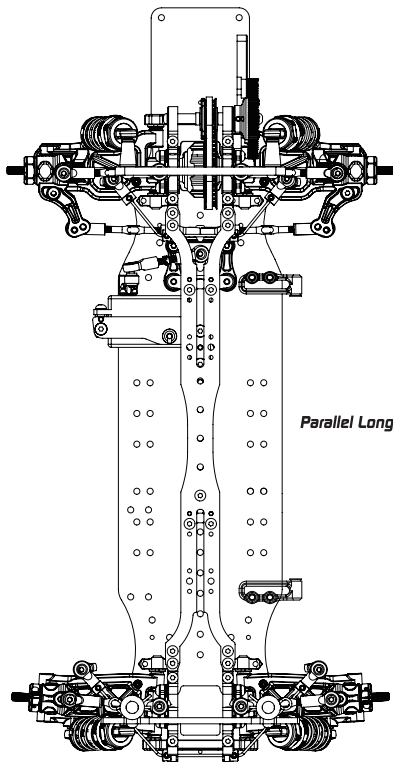
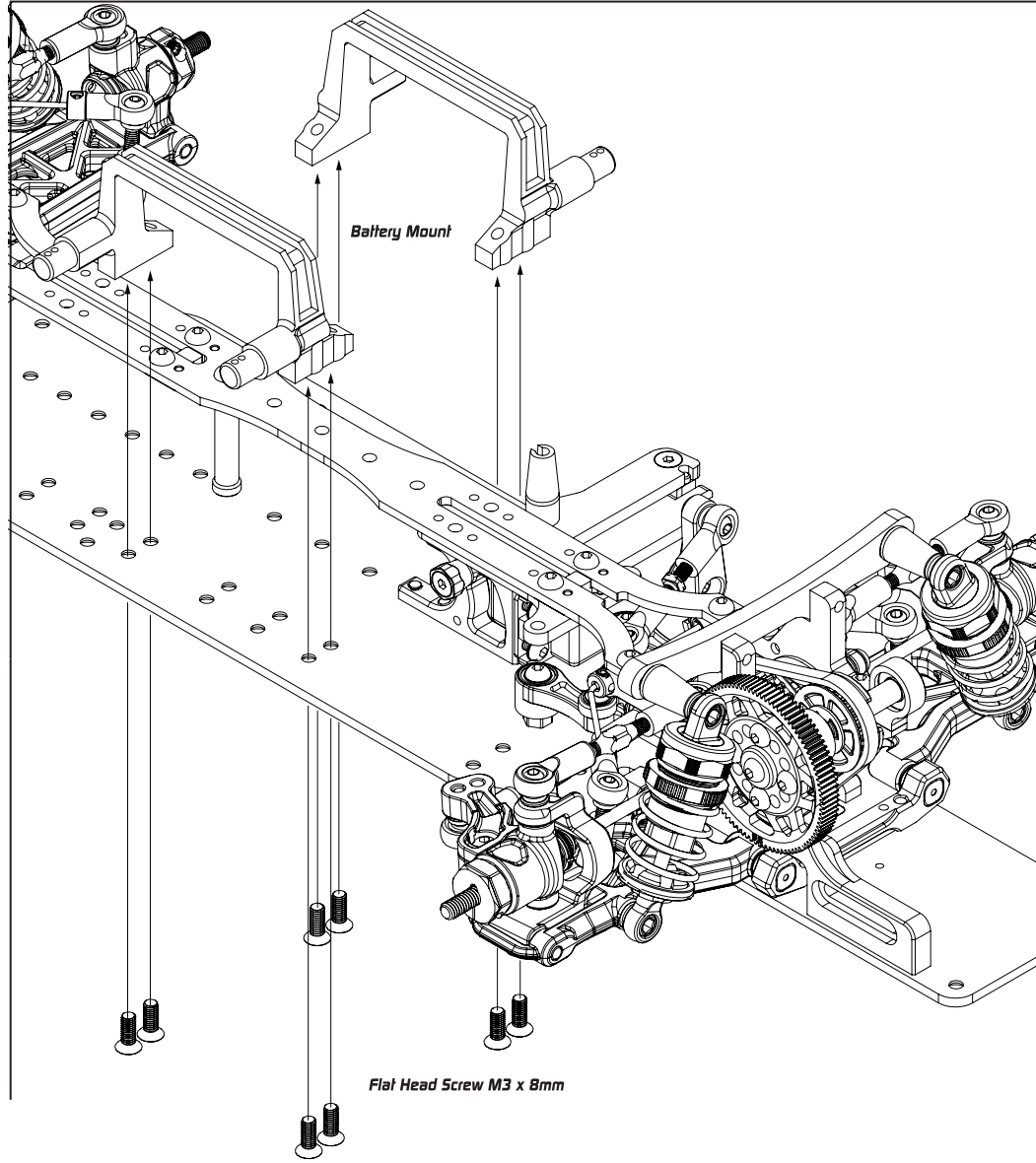

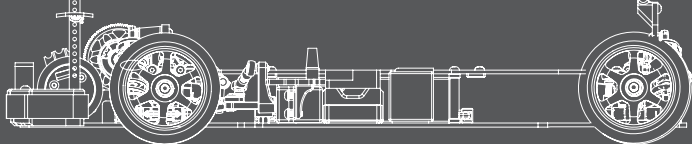

Bag L and Screw Bag

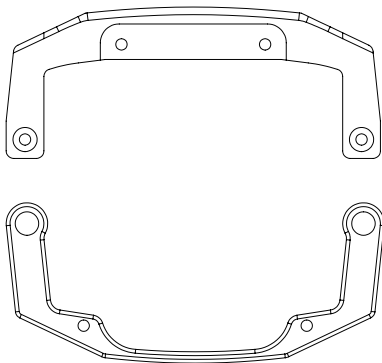

Front Bumper Set
XP-10428

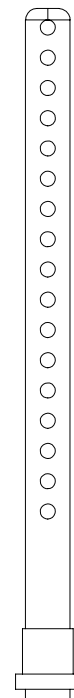

Flat Head Screw M3 x 8mm
XP-40048



Round Head Screw M3 x 8mm
XP-40038



Round Head Screw
M3 x 12mm
XP-40040

Bumper Body Post
XP-10561

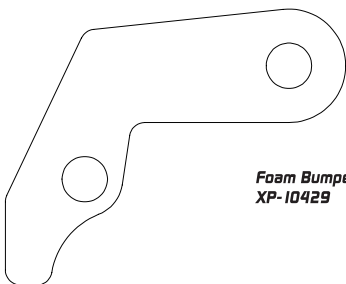

Foam Bumper
XP-10429

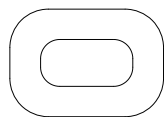

Body Height Adjuster Support
XP-10001

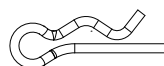

Body Clip
XP-10055

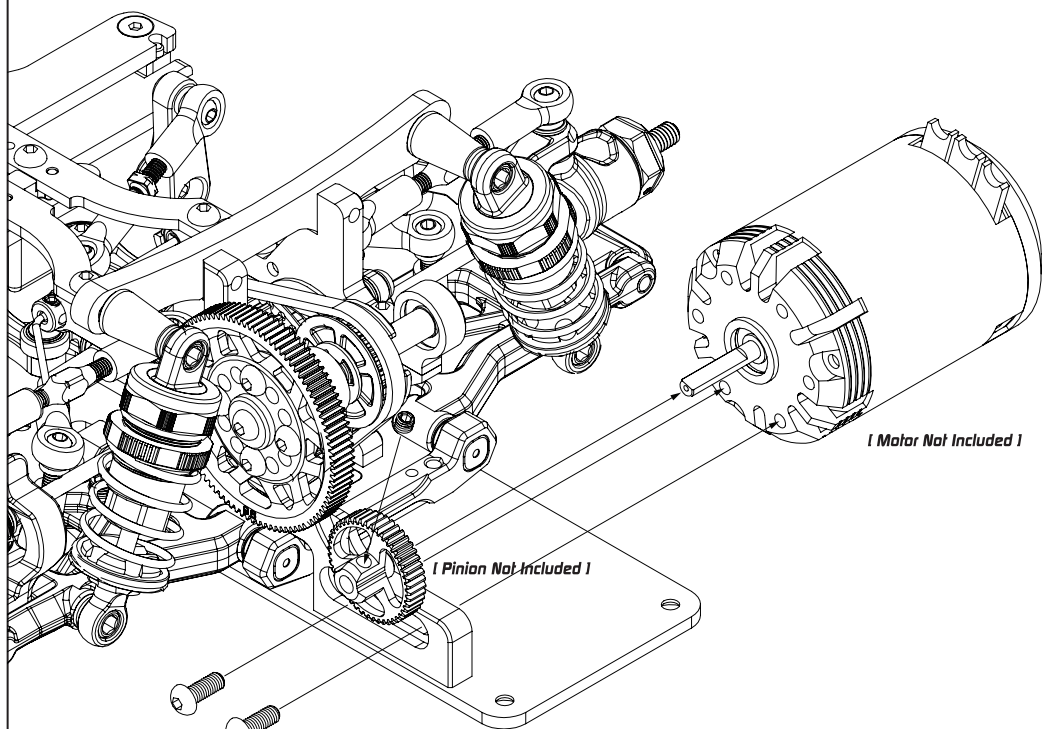

Round Head Screw M3 x 8mm

Round Head Screw M3 x 8mm

Bumper Plate

Body Height Adjuster Support

Foam Bumper

Body Clip

Foam Bumper

Bumper Body Post

Bumper Body Post

Fan Mount

[30mm Cooling Fan Not Included]

Lower Bumper Plate

Flat Head Screw M3 x 8mm

Round Head Screw
M3 x 12mm

Flat Head Screw M3 x 8mm

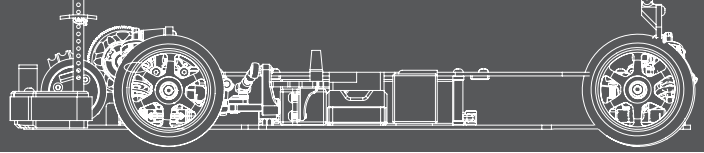

Screw Bag



Hex Screw Flat Head FM3x12mm
XP-40050

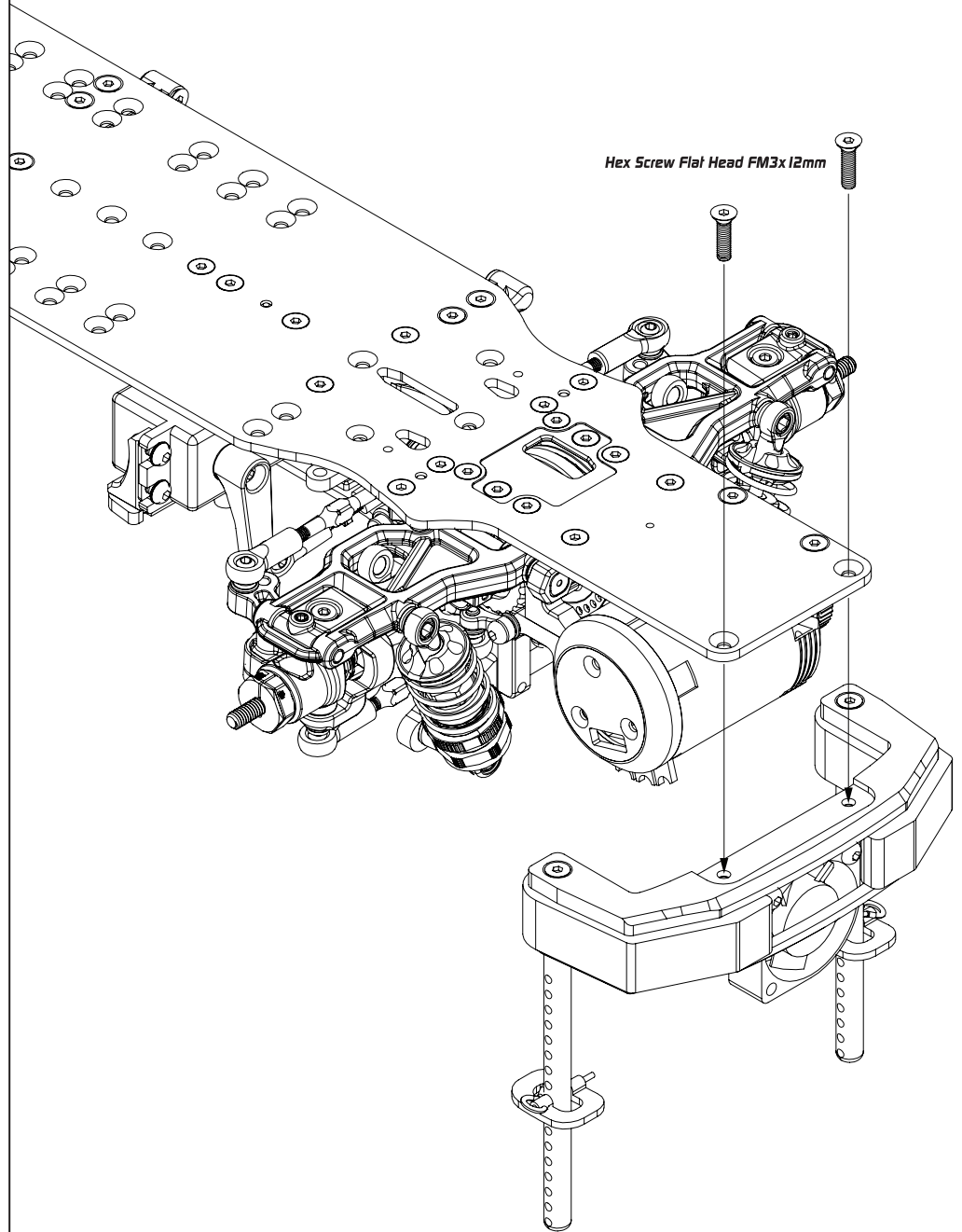

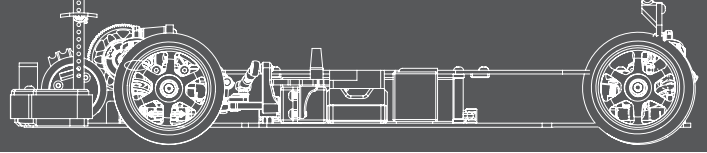

Screw Bag



Lock Nut 7mm
XP-40068

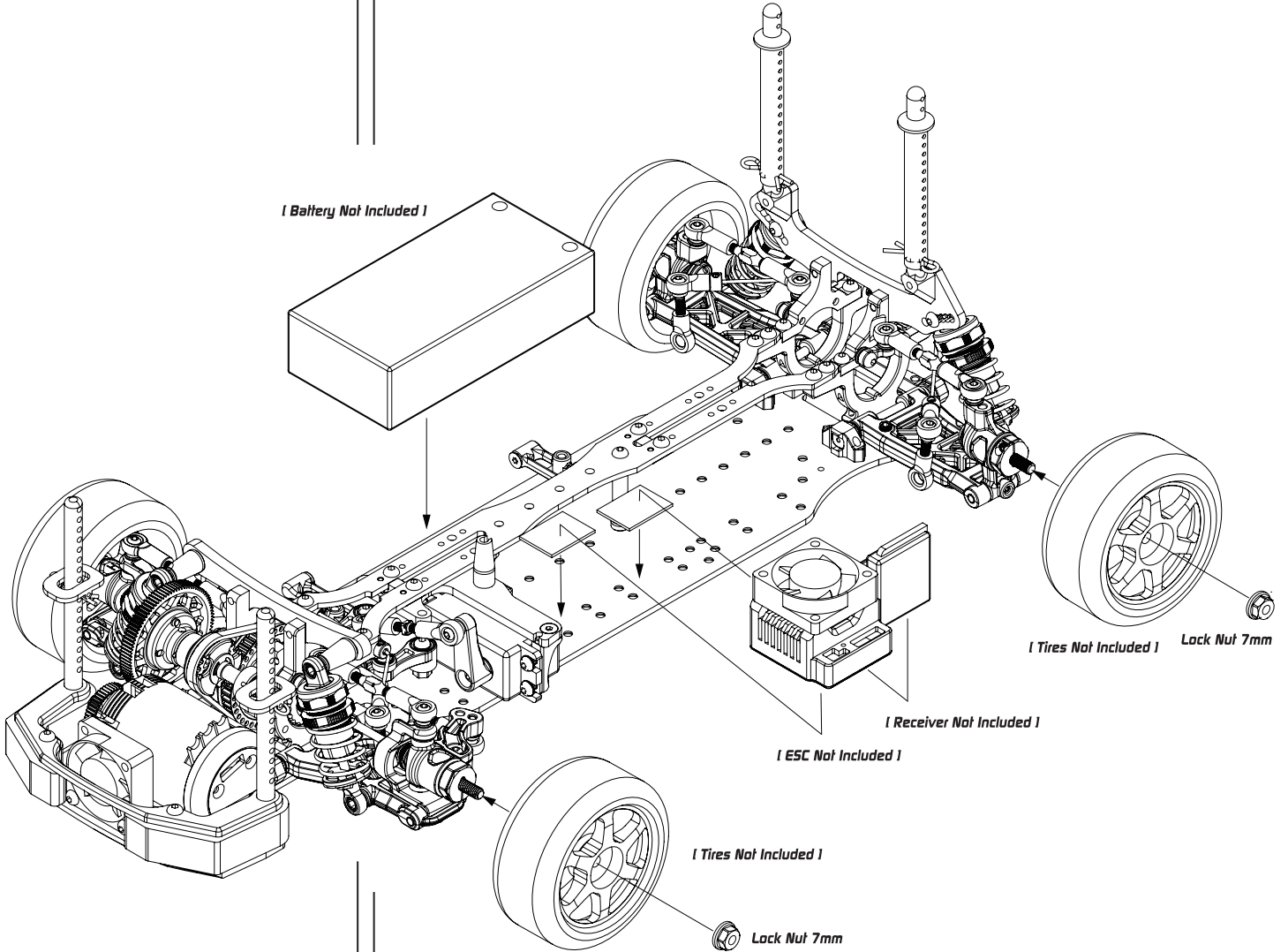

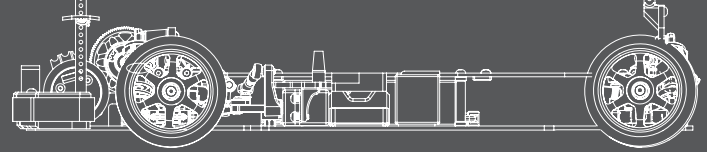

FT1 Original Parts	
Model Number	Product Name
XP-10005	Battery Mount Set
XP-10008	Gear Differential Case and Cover
XP-10009	Gear Differential Bevel Satellite Gears Set
XP-10011	Gear Differential Repair Parts
XP-10022	Gear Differential Set
XP-10105	Front Camberlink Mount 2pcs
XP-10107	Composite Ball Bearing Tension Adjustment Hub 4pcs
XP-10109	Composite Steering Block Pair
XP-10111	Aluminum Dual Servo Saver Arm 2pcs
XP-10113	Aluminum Steering Plate For Dual Servo Saver 4mm
XP-10114	Aluminum FF Lower 1 Piece Suspension Mount
XP-10119	Aluminum Shim 3x5.5x1.0mm Red 20pcs
XP-10120	Aluminum Shim 3x5.5x2.0mm Red 20pcs
XP-10123	Aluminum 2 Piece Suspension Mount 2pcs
XP-10124	Aluminum RR Lower one Piece Suspension Mount
XP-10125	Aluminum Gear Diff Outdrive Adapter 2pcs
XP-10127	Eccentric Bushing Set
XP-10129	Aluminum 5mm Wheel Hub Red 2pcs
XP-10130	Aluminum Rear One Piece Upper Clamp
XP-10136	Aluminum Servo Mount
XP-10139	3.0mm Suspension Pivot Pin 4pcs
XP-10141	Aluminum Low Profile Shock Set 2pcs
XP-10142	Aluminum Shock Body 2pcs
XP-10143	Shock Shaft 2pcs
XP-10191	Aluminum Rf One Piece Suspension Mount
XP-10192	Aluminum Adjustable Battery Stoppers
XP-10193	Aluminum Spring Retainer
XP-10194	Aluminum FR One Piece Suspension Mount
XP-10195	On-power Control System
XP-10196	Brass RF One Piece Suspension Mount
XP-10197	Brass FR One Piece Suspension Mount
XP-10198	Brass 2 Piece Suspension Mount
XP-10199	Brass FF 1 Piece Suspension Mount
XP-10200	Brass RR 1 Piece Suspension Mount
XP-10220	Camberlink Stiffener set
XP-10221	Option Servo Mount Plate (Wire Hide)
XP-10222	Graphite Option Steering Knuckle Plate 2pcs
XP-10223	Aluminum 3.5mm Ackermann Steering Plate For Dual Servo Saver
XP-10224	Aluminum 5mm Ackermann Steering Plate For Dual Servo Saver
XP-10225	Aluminum Ball Bearing Tension Adjustment Hub 2pcs
XP-10226	Steering Toe-In Adjustment Post
XP-10236	4.8mm Ball End 5mm Thread 4pcs
XP-10237	4.8mm Ball End 6mm Thread 4pcs
XP-10238	4.8mm Ball End 8mm Thread 4pcs
XP-10239	4.8mm Ball End 10mm Thread 4pcs
XP-10240	Aluminum Shim 3x5.5x1.0mm Red 10pcs
XP-10241	Aluminum Shim 3x5.5x2.0mm Red 10pcs
XP-10242	Brass Chassis Balancing Weights 10g 5g 4pcs
XP-10244	Steel Universal Shaft 2pcs
XP-10251	4.8mm Flat Type Ball End 15mm 4pcs
XP-10252	4.8mm Flat Type Ball End 13mm 2pcs
XP-10253	4.8mm Flat Type Ball End 10mm 4pcs
XP-10254	4.8mm Low Profile Ball End Set
XP-10255	Camber Stiffener Link Ball End
XP-10256	Aluminum Upper Shock Cap 2pcs
XP-10257	Aluminum Lower Shock Cap 2pcs
XP-10266	Hard Composite On-power Control System Suspension Arm 2pcs

FT1 Original Parts	
Model Number	Product Name
XP-10267	On-power Control System 0 Deg Aluminum C-hub 2pcs
XP-10268	On-power Control System 3mm Graphite Knuckle Plate 2pcs
XP-10269	On-power Control System Ball Stud Set
XP-10334	39.3mm Spring Steel Double Joint Universal Shaft 2pcs
XP-10422	FRP 2.5mm Bottom Chassis Plate
XP-10423	Aluminum Front Bulkhead Left
XP-10424	Aluminum Front Bulkhead Right
XP-10425	Aluminum Front Upper Clamp Left
XP-10426	Aluminum Front Upper Clamp Right
XP-10427	Aluminum Motor Mount
XP-10428	Front Bumper Set
XP-10429	Foam Bumper
XP-10430	FRP 4mm Front Shock Tower
XP-10431	Steel Gearbox Shaft
XP-10432	Brass Lower Bulkhead Plate
XP-10561	Bumper Body Post (Foam Bumer LIGHT)
XP-10565	Composite Suspension Parts Set (Hard Strong)
XP-10566	Upper Deck Stiffener
XP-10567	Spur Gear Adaptor
XP-10568	Composite Lower Bulkhead
XP-10569	Composite Upper Bulkhead Set
XP-10570	Aluminium Front Shock Tower Spacer
XP-10571	FRP 3.5mm Rear Shock Tower
XP-10572	Graphite 2.25mm Bottom Chassis Plate
XP-10574	Graphite 3.5mm Rear Shock Tower
XP-10575	Kevlar Drive Belt Front 3 x 150mm
XP-10576	Rear Wheel Axle
XP-10577	SHORT SHOCK COMPOSITE SHOCK PARTS
XP-10578	Aluminum SHORT SHOCK CAP 2pcs
XP-10579	Aluminum Lower Short Shock Cap 2pcs
XP-10580	Aluminum SHORT SHOCK ADJUSTABLE NUT 2pcs
XP-10581	Aluminum SHORT SHOCK BODY 2pcs
XP-10582	SHORT SHOCK SHAFT 2pcs
XP-10587	SHORT SHOCK SET 2PCS
XP-10588	Separate Bulkhead Type A
XP-10589	Separate Bulkhead Type B
XP-10590	Separate Upper Bulkhead RR
XP-10591	Separate Upper Bulkhead RL
XP-10592	Graphite 2mm TopDeck
XP-10597	Front And Rear Composite Suspension Arm (Strong Hard)
XP-10598	Composite C Hub 4 Degree L/R (Strong Hard)
XP-10599	Composite Rear Upright 2 PCS (Strong Hard)
XP-10600	Silicone Gear Differential X-RING 5x2mm 10pcs
XP-10601	Shock X-RING 8pcs
XP-10602	3mm Flat Spot Suspension C Hub Upright Pivot Pin 4pcs
XP-10603	Front And Rear Composite Suspension Arm (Strong)
XP-10604	Composite C Hub 4 Degree L/R (Strong)
XP-10605	Composite Rear Upright 2 PCS (Strong)
XP-10606	Composite Suspension Parts Set (Strong)
XP-10607	O Ring For Spring Adjust Nut 4pcs (Short Shock)
XP-10610	XQ1 XQ1S Double Joint Universal Shaft Bone
XP-10611	XQ1 XQ1S Double Joint Universal Shaft Axle
XP-10612	XQ1 XQ1S Double Joint Universal Shaft Case
XP-10613	XQ1 XQ1S Double Joint Universal Shaft Coupling Pins
XP-10617	Chassis Stiffener Post
XP-10618	Drive Belt Front 3 x 150mm

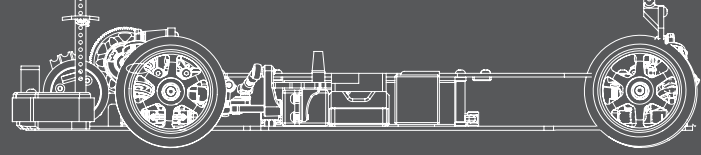

Xpress Execute FT1 (64Pitch-Spur Gear 88T to 110T)

		Pinion																								
		19	20	21	22	23	24	25	26	27	28	29	30	31	32	33	34	35	36	37	38	39	40	41	42	
88																										
89																								4.2	4.1	4.0
90																							4.4	4.3	4.2	4.1
91																					4.6	4.4	4.3	4.2	4.1	
92																				4.7	4.6	4.5	4.4	4.3	4.2	
93																			5.5	4.8	4.7	4.5	4.4	4.3	4.2	
94																		5.1	5.6	4.8	4.7	4.6	4.5	4.4	4.3	
95																6.0	5.2	5.7	4.9	4.8	4.7	4.6	4.5	4.4	4.3	
96															5.5	6.1	5.2	5.7	4.9	4.8	4.7	4.6	4.5	4.4	4.3	
97															5.8	5.6	6.1	5.3	5.8	5.0	4.9	4.7	4.6	4.5	4.4	
98														6.0	5.8	6.2	5.3	5.8	5.0	4.9	4.8	4.7	4.5	4.4	4.3	
99													6.3	6.1	5.9	5.7	6.3	5.4	5.9	5.1	5.0	4.8	4.7	4.6	4.5	
100													6.6	6.3	6.1	5.9	6.3	5.4	5.9	5.1	5.0	4.9	4.8	4.6	4.5	
101													6.9	6.6	6.4	6.2	6.4	5.5	6.0	5.2	5.1	4.9	4.8	4.7	4.6	
102													7.2	6.9	6.7	6.5	6.3	6.1	5.9	6.1	5.2	5.1	5.0	4.8	4.7	
103													7.5	7.2	7.0	6.7	6.5	6.3	6.1	5.9	6.1	5.2	5.1	4.9	4.8	
104													7.9	7.6	7.3	7.1	6.8	6.6	6.4	6.2	6.0	5.6	5.6	5.1	4.9	
105													8.3	8.0	7.7	7.4	7.1	6.9	6.7	6.4	6.2	6.0	5.7	5.1	4.9	
106													8.8	8.4	8.1	7.7	7.5	7.2	6.9	6.7	6.5	6.3	6.1	5.0	4.9	
107													9.2	8.8	8.5	8.1	7.8	7.5	7.3	7.0	6.8	6.6	6.4	5.2	5.1	
108													9.8	9.3	8.9	8.6	8.2	7.9	7.6	7.3	7.1	6.8	6.6	5.4	5.0	
109													10.4	9.9	9.4	9.0	8.6	8.3	8.0	7.7	7.4	7.1	6.9	5.5	5.1	
110													11.0	10.5	10.0	9.5	9.1	8.7	8.4	8.0	7.7	7.5	7.2	5.5	5.1	

64 Pitch

Xpress Execute FT1 (64Pitch-Spur Gear 88T to 110T)

		Pinion																							
		43	44	45	46	47	48	49	50	51	52	53	54	55	56	57	58	59	60	61	62	63	64	65	66
3.9	3.8	3.7	3.6	3.6	3.6	3.6	3.5	3.4	3.3	3.3	3.2	3.2	3.1	3.0	3.0	2.9	2.9	2.8	2.8	2.7	2.7	2.7	2.6	2.5	
3.9	3.8	3.8	3.7	3.6	3.6	3.6	3.5	3.5	3.4	3.3	3.2	3.2	3.1	3.0	3.0	2.9	2.9	2.8	2.8	2.8	2.7	2.6	2.6		
4.0	3.9	3.8	3.7	3.6	3.6	3.6	3.5	3.5	3.4	3.4	3.3	3.2	3.2	3.1	3.0	2.9	2.9	2.9	2.9	2.8	2.8	2.7	2.7		
4.0	3.9	3.8	3.8	3.7	3.6	3.6	3.5	3.5	3.5	3.4	3.3	3.3	3.2	3.1	3.0	2.9	2.9	2.9	2.9	2.8	2.8	2.7			
4.1	4.0	3.9	3.8	3.7	3.6	3.6	3.6	3.5	3.5	3.4	3.4	3.3	3.2	3.1	3.0	2.9	2.9	2.9	2.9	2.8	2.8	2.7			
4.1	4.0	3.9	3.8	3.8	3.7	3.6	3.7	3.6	3.5	3.5	3.4	3.3	3.2	3.1	3.0	2.9	2.9	2.9	2.9	2.8	2.8	2.7			
4.2	4.1	4.0	3.9	3.8	3.7	3.6	3.7	3.6	3.6	3.5	3.4	3.3	3.2	3.1	3.0	2.9	2.9	2.9	2.9	2.8	2.8	2.7			
4.2	4.1	4.0	3.9	3.8	3.7	3.6	3.8	3.7	3.6	3.5	3.5	3.4	3.3	3.2	3.1	3.0	3.0	3.0	3.0	2.9	2.9	2.8			
4.2	4.1	4.1	4.0	3.9	3.8	3.7	3.6	3.7	3.6	3.5	3.4	3.4	3.3	3.2	3.1	3.0	3.0	3.0	3.0	2.9	2.9	2.8			
4.3	4.2	4.1	4.0	3.9	3.8	3.7	3.6	3.8	3.7	3.6	3.5	3.4	3.4	3.3	3.2	3.1	3.0	3.0	3.0	2.9	2.9	2.8			
4.3	4.2	4.1	4.0	4.0	3.9	3.8	3.7	3.8	3.7	3.7	3.6	3.5	3.4	3.4	3.3	3.2	3.1	3.0	3.0	2.9	2.9	2.8			
4.4	4.3	4.2	4.1	4.0	4.0	3.9	3.9	3.8	3.8	3.7	3.6	3.5	3.4	3.4	3.3	3.2	3.1	3.0	3.0	2.9	2.9	2.8			
4.4	4.3	4.2	4.1	4.0	4.0	4.0	4.0	3.9	3.8	3.7	3.6	3.5	3.5	3.4	3.3	3.2	3.1	3.0	3.0	2.9	2.9	2.8			
4.5	4.4	4.3	4.2	4.1	4.0	3.9	3.8	3.8	3.8	3.8	3.7	3.6	3.5	3.4	3.3	3.2	3.1	3.0	3.0	2.9	2.9	2.8			
4.5	4.4	4.3	4.2	4.1	4.0	3.9	3.8	3.8	3.8	3.8	3.7	3.6	3.5	3.4	3.3	3.2	3.1	3.0	3.0	2.9	2.9	2.8			
4.6	4.4	4.3	4.3	4.2	4.1	4.0	4.1	4.0	3.9	3.8	3.7	3.6	3.5	3.4	3.3	3.2	3.1	3.0	3.0	2.9	2.9	2.8			
4.6	4.5	4.4	4.3	4.2	4.1	4.0	4.1	4.0	4.0	4.0	3.9	3.8	3.7	3.6	3.5	3.4	3.3	3.2	3.1	3.0	2.9	2.8			
4.6	4.5	4.4	4.3	4.2	4.1	4.0	4.2	4.1	4.0	3.9	3.8	3.7	3.6	3.5	3.4	3.3	3.2	3.1	3.0	2.9	2.9	2.8			
4.7	4.6	4.5	4.4	4.3	4.2	4.1	4.2	4.1	4.0	3.9	3.8	3.7	3.6	3.5	3.4	3.3	3.2	3.1	3.0	2.9	2.9	2.8			
4.7	4.6	4.5	4.4	4.3	4.2	4.1	4.3	4.2	4.1	4.0	3.9	3.8	3.7	3.6	3.5	3.4	3.3	3.2	3.1	3.0	2.9	2.8			
4.8	4.7	4.6	4.5	4.4	4.3	4.2	4.4	4.3	4.2	4.1	4.0	3.9	3.8	3.7	3.6	3.5	3.4	3.3	3.2	3.1	3.0	2.9	2.8		
4.8	4.7	4.6	4.5	4.4	4.3	4.2	4.5	4.4	4.3	4.2	4.1	4.0	3.9	3.8	3.7	3.6	3.5	3.4	3.3	3.2	3.1	3.0	2.9	2.8	
4.9	4.8	4.7	4.6	4.5	4.4	4.3	4.6	4.5	4.4	4.3	4.2	4.1	4.0	3.9	3.8	3.7	3.6	3.5	3.4	3.3	3.2	3.1	3.0	2.9	

Driver _____ **Track Surface** _____ **Track Temperature** _____
Date _____ **Track Traction** _____ **Result** _____ **Air Temperature** _____
Track _____ **Country** _____ **Best Lap** _____ **Humidity** _____ **Remark** _____

Front **Rear**

C-Hub
 M H
Steering Block
 M H
Suspension Arm
 M H

Hex Offset _____ mm _____ mm
Camber _____
Ride Height _____ mm _____ mm
DownStop _____ mm _____ mm
Sway Bar _____ mm _____ mm

Rear Hub
 M H
Suspension Arm
 M H

Optional **On-Power Control System**

Hex Offset _____ mm
Camber _____
Ride Height _____ mm
DownStop _____ mm
Sway Bar _____ mm

Steering Block
 M H
Suspension Arm
 M H

Front **Rear**
Toe Out _____ **Front Tire Additive Arena**
Lower Arm Spacer _____ mm **Bump Steering Spacer** _____ mm
Link Spacer _____ mm **Weight** _____ g
Wheelbase Spacer _____ mm **Spacer** _____ mm
FF _____ mm **FR** _____ mm
FR _____ mm **RR** _____ mm

Floating Steering
 Non-Floating Steering

Rear Toe In _____ **Rear Tire Additive Arena**
Lower Arm Spacer _____ mm
Shock Tower Spacer _____ mm
Link Spacer _____ mm
Wheelbase Spacer
RF _____ mm **RR** _____ mm **Weight** _____ g

Suspension Mount Setup

FF
 1 0.5
RR
 1 0.5
FR
 1 0.5
RF
 1 0.5

Battery Position

Damper Setup

	Front	Rear
Spring	_____	_____
Oil	_____	_____
Rebound	_____	_____
Piston	_____	_____
Length	_____	_____
Foam Insert	<input type="checkbox"/>	<input type="checkbox"/>
Hole In Cap	<input type="checkbox"/>	<input type="checkbox"/>

Transmission Setup

	Front	Rear
Gear Diff	_____	_____
Oil	_____	_____
Weight	_____ g	_____ g
Position	_____	_____

Others

Servo _____ **Tires** _____
Esc _____ **Additive** _____
Motor _____ **Body** _____
Spur _____ P/ _____ T Rear Wing
Pinon _____ P/ _____ T FDR

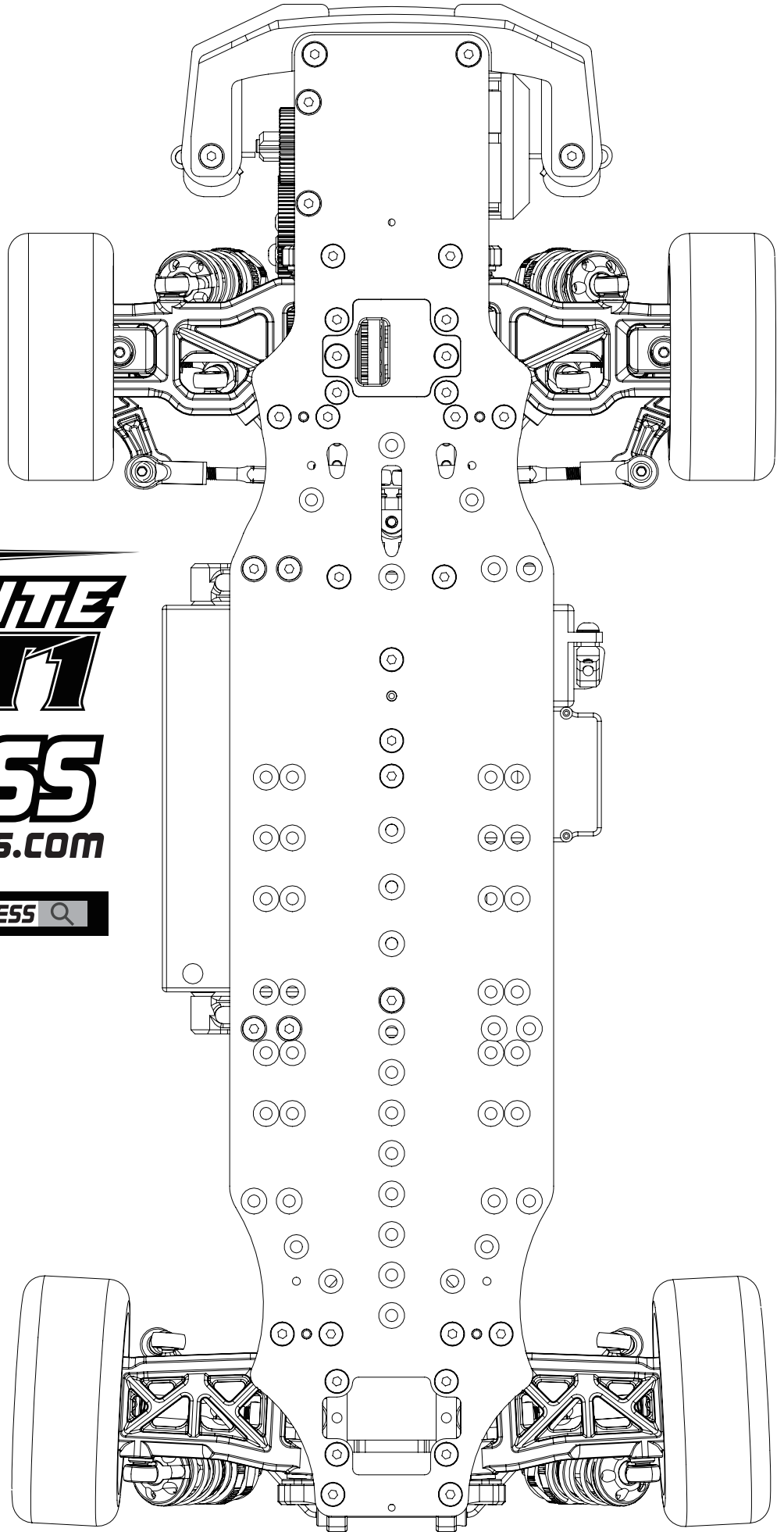

EXECUTE
1/10 COMPETITION FWD TOURING CAR
F11

XPRESS
www.rc-xpress.com

