

DRIVER: Rick van den Akker	TRACK: AMCA, Apeldoorn (NL)	TRANSMITTER: Futaba 10PX	BATTERY: LRP 6300	TIRES: Matrix Z36
DATE: May 31, 2026	SURFACE: ASPHALT <input checked="" type="radio"/> CARPET <input type="radio"/>	RECEIVER:	MOTOR: Hobbywing 17.5 ETS	ADDITIVE: MR33 V3
OUTSIDE TEMPERATURE°C: 25-30	LAYOUT: TECHNICAL <input type="radio"/> MIXED <input type="radio"/> FAST <input checked="" type="radio"/>	SERVO: MKS HBL 575 SL	PINION TYPE & T: 41	WARMER C°: 80
TRACK TEMPERATURE°C: 40+	TRACTION: LOW <input type="radio"/> MEDIUM <input type="radio"/> HIGH <input checked="" type="radio"/>	STEERING EXPO: -20	SPUR TYPE & T: 82	WARMER TIME: 2x 10
VER. 3101-1	RACE: ETS 2026	STEERING SPEED:		SIDEWALL GLUE: X

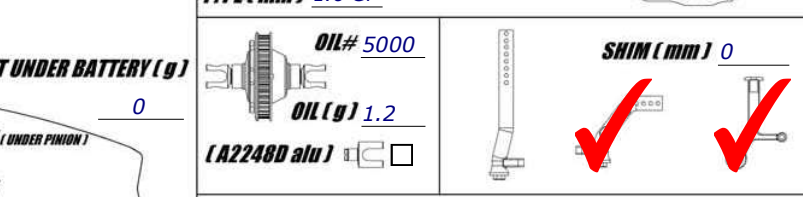
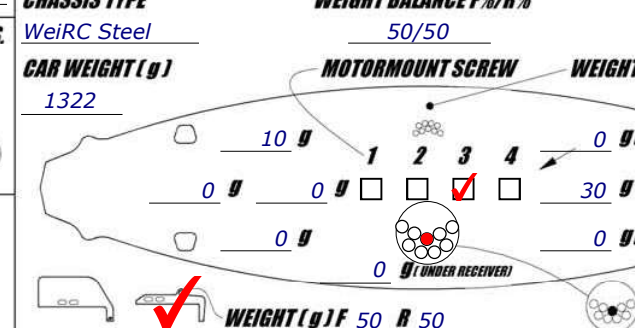
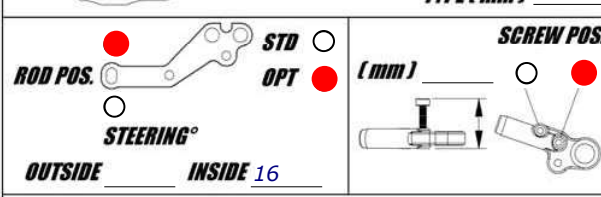
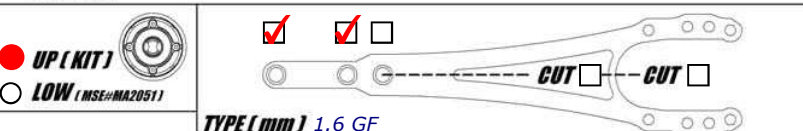
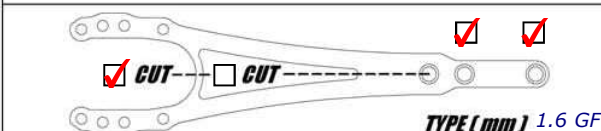
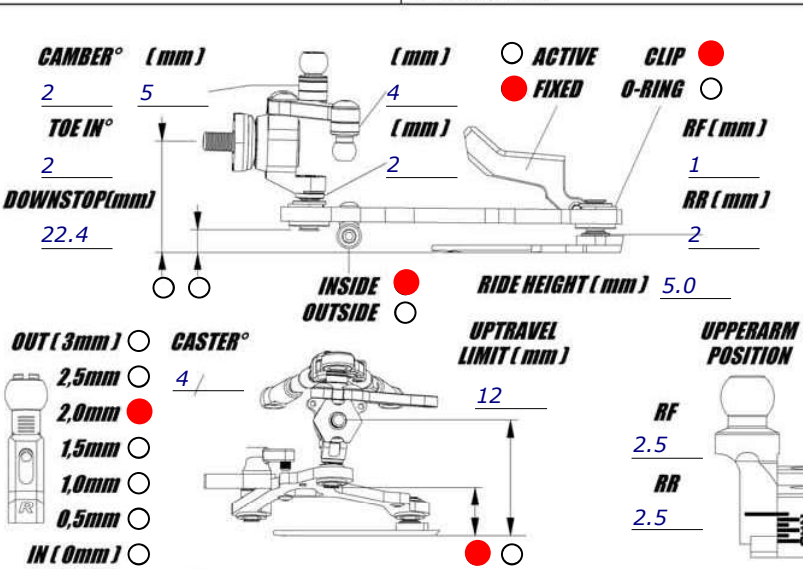
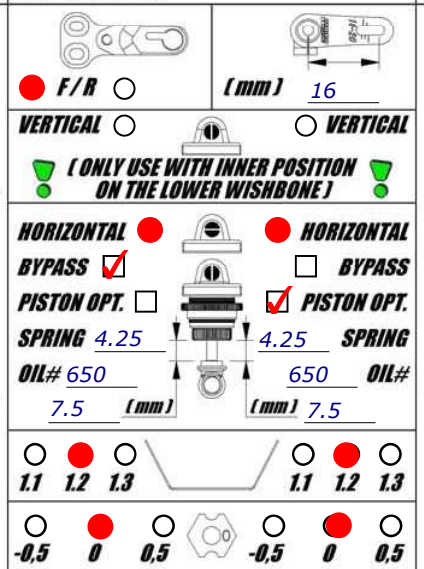
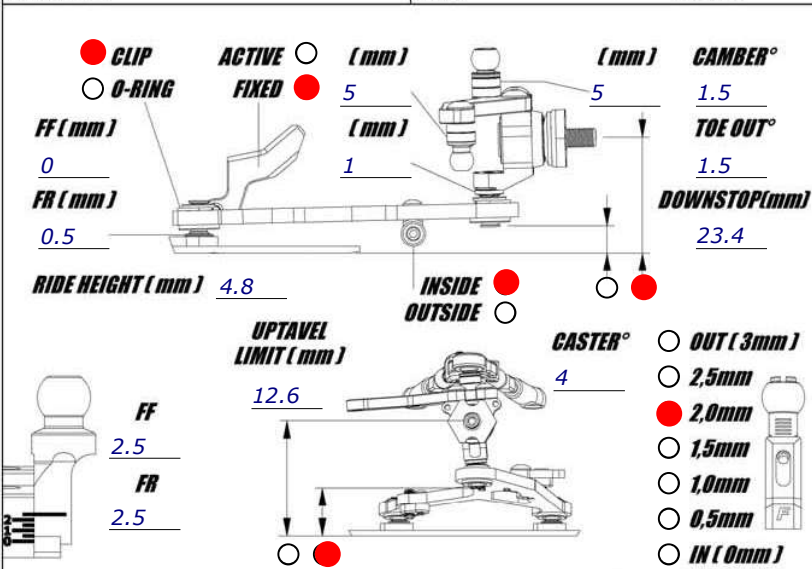

INFO

Shocks, 6 hole piston front + rear, 650 Mugen oil.

Diff, 5000 Hudy oil, sand the gears to make the diff more smooth

Set screw in motormount hole #4

