

DRIVER: Rick van den Akker
 DATE: May 25, 2026
 OUTSIDE TEMPERATURE°C: 30
 TRACK TEMPERATURE°C: 45
 VER. 3101-1

TRACK: AMCA, Apeldoorn
 SURFACE: ASPHALT CARPET
 LAYOUT: TECHNICAL MIXED FAST
 TRACTION: LOW MEDIUM HIGH
 RACE: PRE ETS RESULT:

TRANSMITTER: Futaba 10px
 RECEIVER:
 SERVO: MKS
 STEERING EXPO: -20
 STEERING SPEED: default

BATTERY: LRP 5100
 MOTOR: Hobbywing G4R 17.5 ETS
 PINION TYPE & T: 41
 SPUR TYPE & T: 82

TIRES: Matrix Z36 ETS
 ADDITIVE: MR33 V3 ETS
 WARMER C°: 80
 WARMER TIME:
 SIDEWALL GLUE:

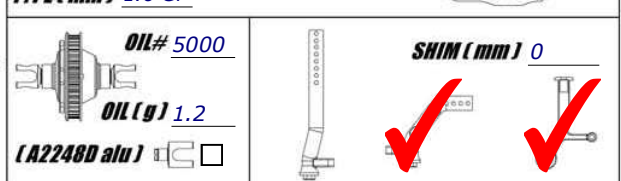
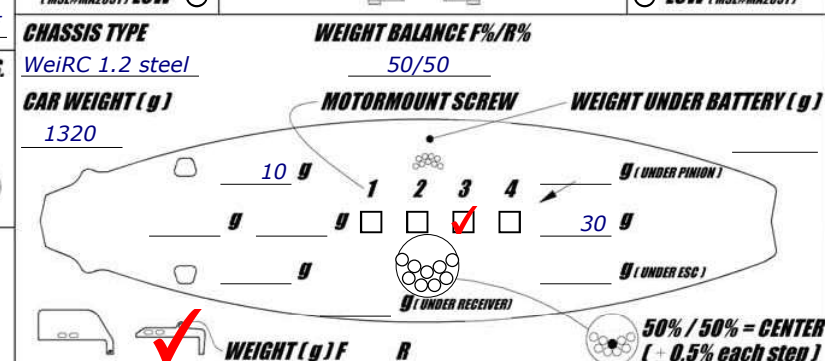
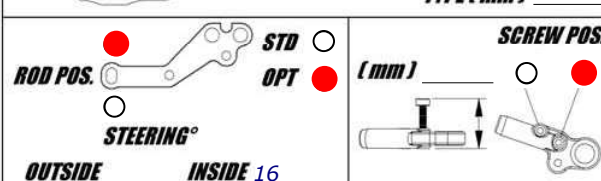
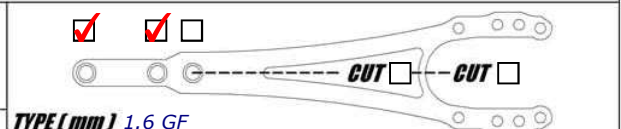
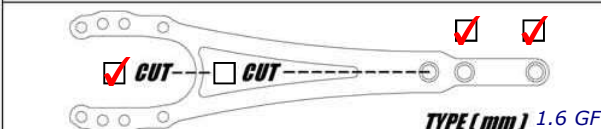
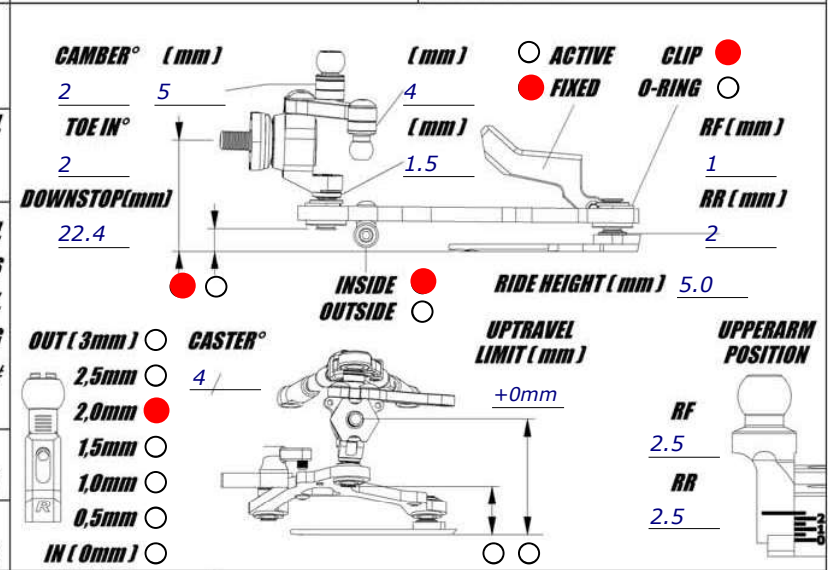
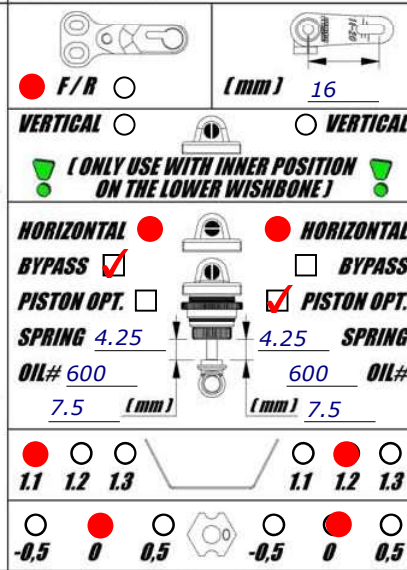
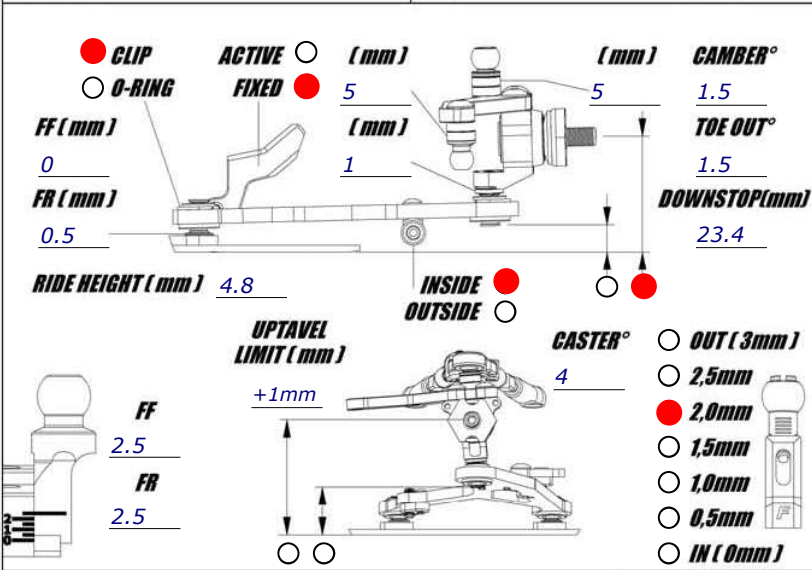

INFO
 Mugen shock oil
 Hudy diff oil
 Front bypass + 6 holes piston
 rear normal shock + 6 holes piston

