

CERO ULTRA

1/10 Scale Radio Control Touring Car Setup Sheet

Qualifying:	Final:	Best Lap:
Environment:	<input type="checkbox"/> Indoor	<input type="checkbox"/> Outdoor
Composition:	<input type="checkbox"/> Asphalt	<input type="checkbox"/> Carpet
Traction:	<input type="checkbox"/> Low	<input type="checkbox"/> <input type="checkbox"/> High
Surface:	<input type="checkbox"/> Smooth	<input type="checkbox"/> Bumpy
Layout:	<input type="checkbox"/> Technical	<input type="checkbox"/> Mixed <input type="checkbox"/> Open

Driver: _____ Date: _____ Track: _____
 Event: _____ Class: Blinky Open Stock Modified

FRONT

Transmission
 Spool
 Gear
 Oil: _____
 Weight: _____

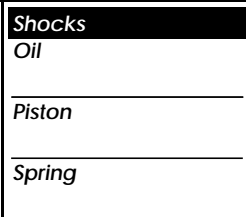
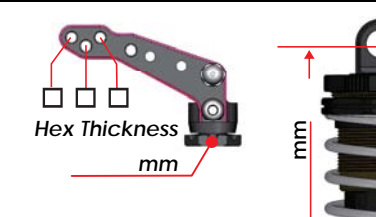
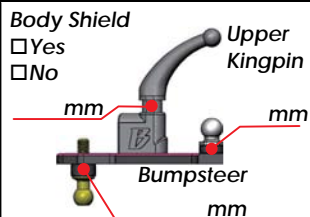

Ride Height _____
 Camber _____
 Caster _____
 Toe _____
 Sway Bar _____
 Droop _____
 Downstop _____

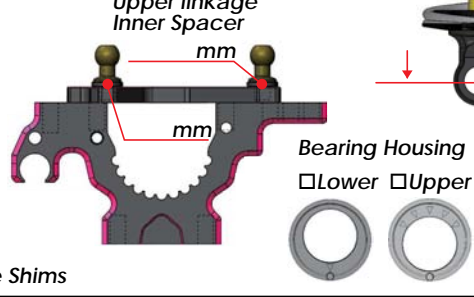
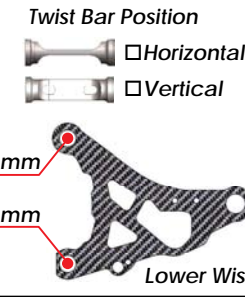
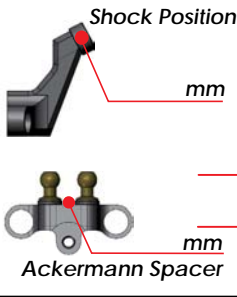

REAR

Transmission
 Spool
 Gear
 Oil: _____
 Weight: _____

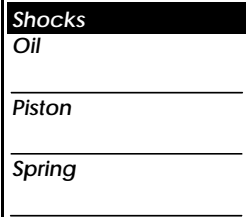

Ride Height _____
 Camber _____
 Caster _____
 Toe _____
 Sway Bar _____
 Droop _____
 Downstop _____

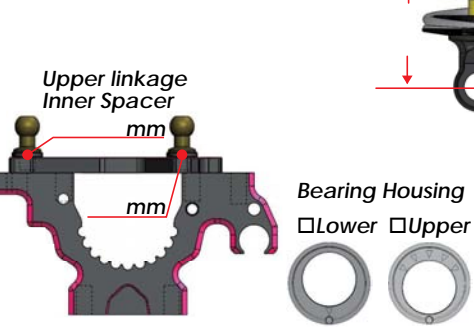
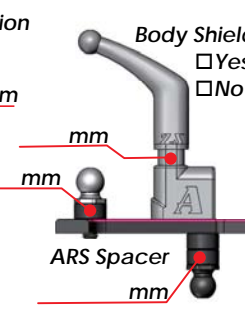
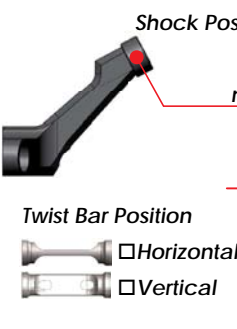

OTHER

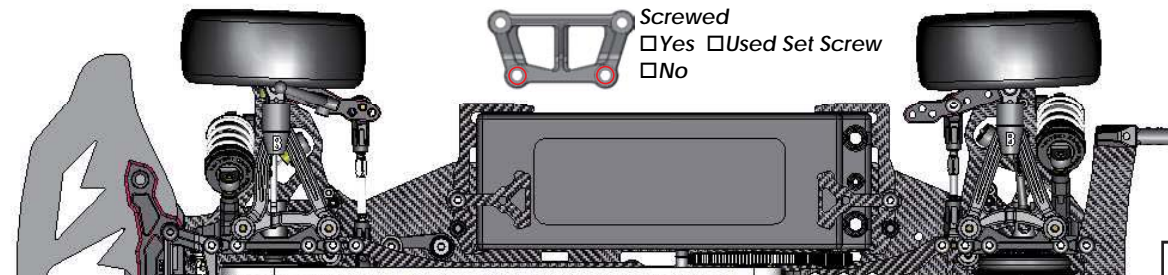
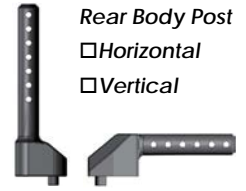
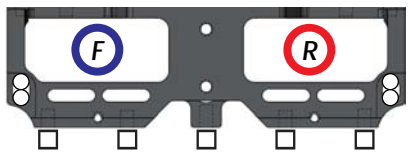
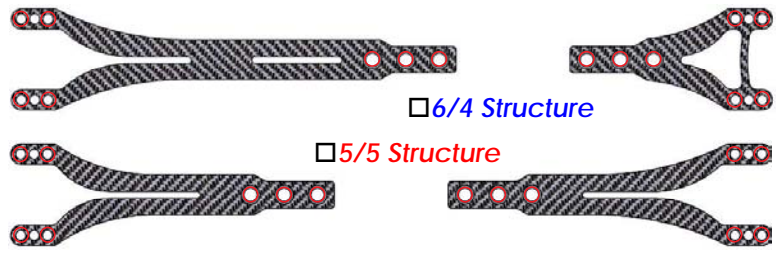

Track Width
 Front _____
 Rear _____
 Wheelbase _____
 Weight _____

FRONT	REAR		
Tyres		Body	Wing
Insert		Motor	Battery
Wheel		ESC	Servo
Treatment		Spur	Pinion
Treatment time			Pitch
		Final Drive Ratio (1.9 x Spur/Pinion)=	

ARNOLD PETITRE