

FACTORY X-6³ Setup sheet

Arm0 - V1.0

Driver: _____ Date: _____
 Event: _____
 Track: _____

Track Condition

Composition: Astroturf Blue Groove Carpet Clay Dirt Grass Other: _____
 Layout: Open Tight Surface: Bumpy Smooth Grip: Low Medium High

Front Suspension

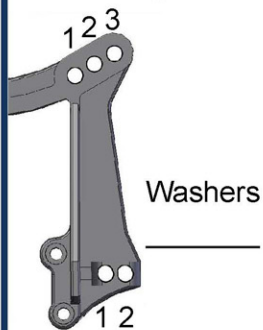

Toe: _____ Axles: Trailing Inline
 Camber: _____ Caster Block: 20° 25° 30°
 Ride Height: _____ Ackermann: Forward Back

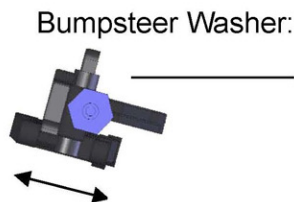

Forward Hub Position Back

Front Shocks

Brand: _____
 Spring: _____
 Piston: _____
 Oil: _____ Emulsion: Yes No
 Limiters: _____

Front Tires

Tire: _____
 Insert: _____
 Wheels: _____

Rear Suspension

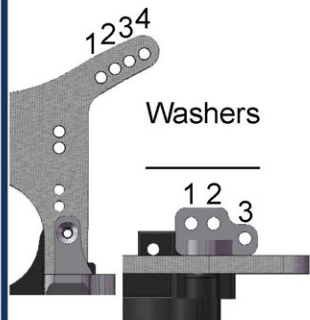

Camber: _____
 Ride Height: _____
 Transmission Height: _____
 Swaybar: _____

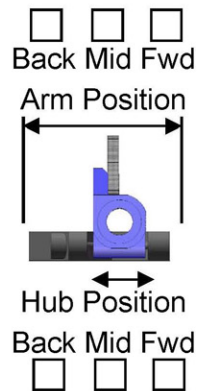
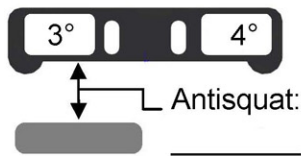
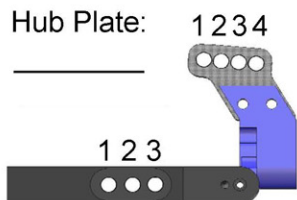

Rear Shocks

Brand: _____
 Spring: _____
 Piston: _____
 Oil: _____ Emulsion: Yes No
 Limiters: _____

Rear Tires

Tire: _____
 Insert: _____
 Wheels: _____

Weighs:

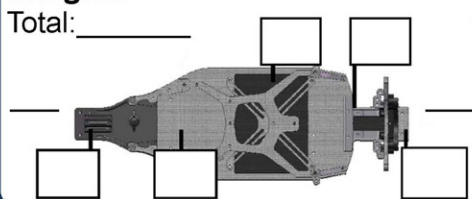

Comments:

Battery: _____
 Motor: _____
 Gearing: _____
 ESC: _____
 ESC Settings: _____