

T4



www.teamcracing.net

SETUP SHEET for the TeamC T4

Editable by Arn0 at PetitRC.com

Driver _____

Track / City _____

Event _____ Date ____ / ____ / ____

Conditions

- Smooth Bumpy Low traction Med traction High traction
 Sandy Soft dirt Grass Hard soil Clay Wet Dry Dusty Other

Front Suspension Shock Mounting&Camber link

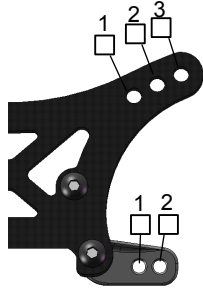

Anti-roll bar: _____ mm

Camber _____ °

Washers _____ mm

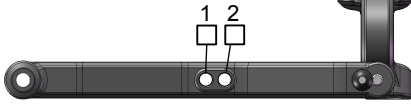

Toe-in (+)/Out (-) _____ °
Bump Step Spacer _____

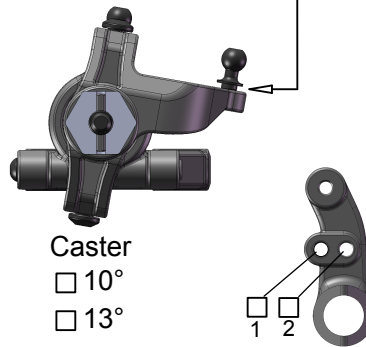

Caster

- 10°
 13°

Ride height _____

Front Shocks

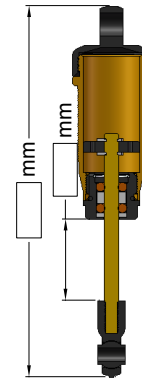

Spring(color)

Black

Oil _____ wt

Piston # _____

Rear Suspension Shock Mounting&Camber link

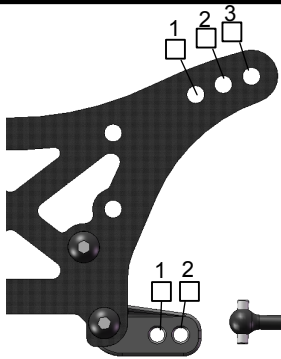

Anti-roll bar: _____ mm

Camber _____ °

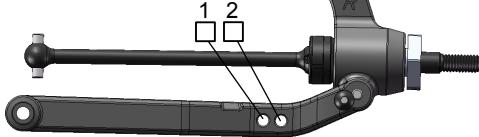
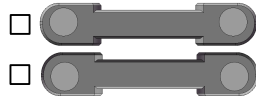

Wheelbase

Long

Medium

Short

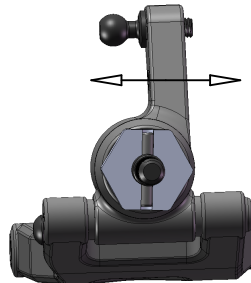

Ride height _____

Rear Shocks

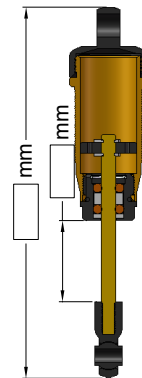

Spring(color)

Black

Oil _____ wt

Piston # _____

Front Tires&Wheels

Front Tires _____

Inserts _____ Wheels _____

Rear Tires&Wheels

Rear Tires _____

Inserts _____ Wheels _____

Batteries

Servo _____

Esc _____

Batteries _____

Motor

Motor _____

Pinion/Spur _____ / _____

Other

Wing _____

Wing Angle 4° 10°

Comments

Notes _____
