



PRSIVE(FM)
V3 REVOL
2020

Arr0 - PetliRC.com

Name _____

Date _____

Track/City _____

Event _____

Front Suspension

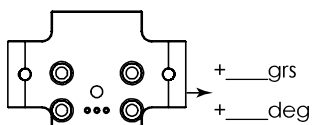
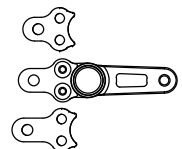
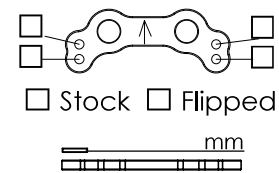
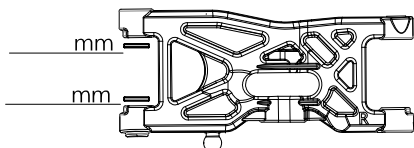
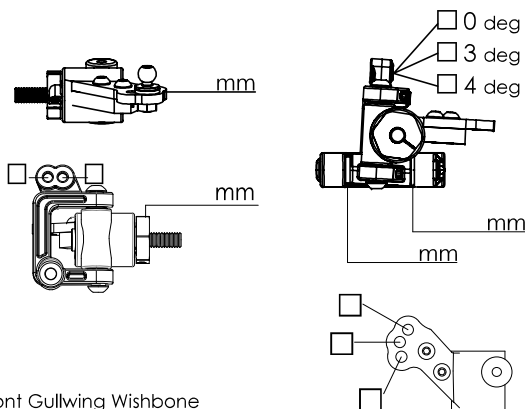
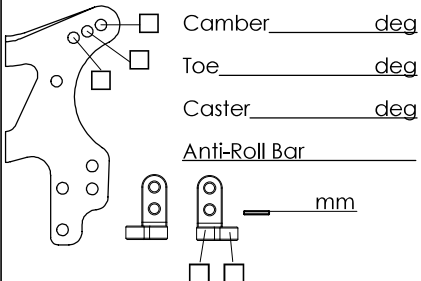

Shock Oil _____

Shock Piston _____

Spring _____

Preload _____ mm

O-Ring Blue Red

Limiters

Inside _____ mm

Outside _____ mm

Notes

Rear Suspension

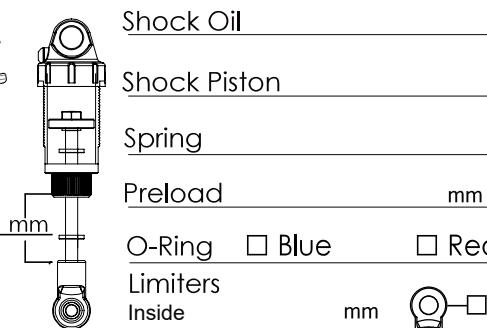
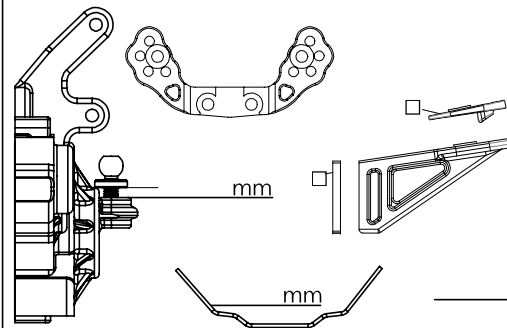
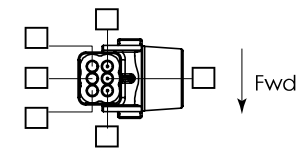
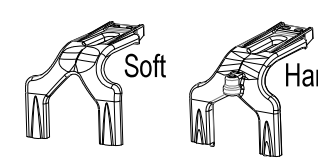
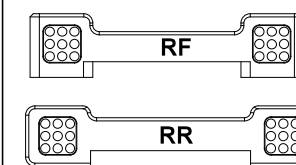
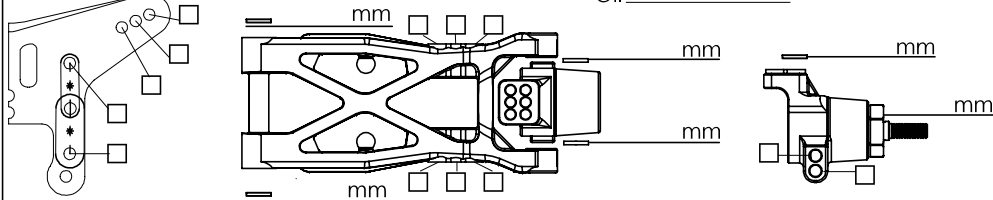
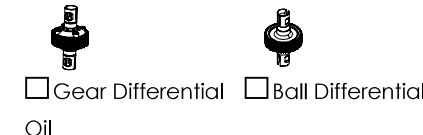
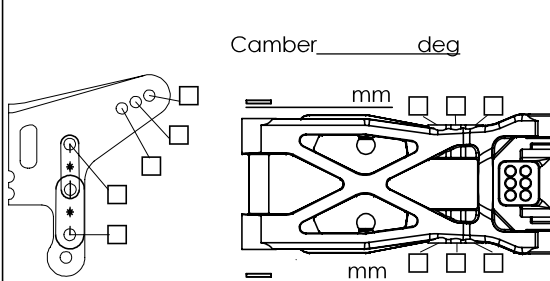

Notes

Tires & Wheels

Front Tire _____	Rear Tire _____
Wheel _____	Wheel _____
Inserts _____	Inserts _____

Notes

Battery Position

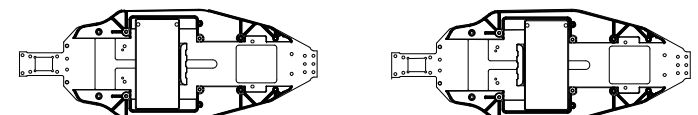

Temp

Track Conditions

Humidity

Composition: Astro Carpet Clay Dirt Grass
Layout: Open Mixed Tight
Traction: Low Medium High
Surface: Smooth Bumpy

Others

ESC _____
Motor _____
Battery _____
Pinion/Spur _____
Wing _____