



PRSIVE(FM)
V3 REVOL
2020

Arr0 - PetliRC.com

Name _____

Date _____

Track/City _____

Event _____

Front Suspension

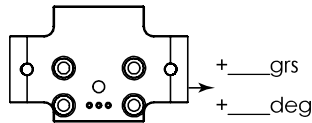
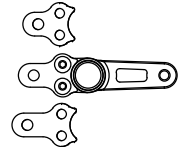
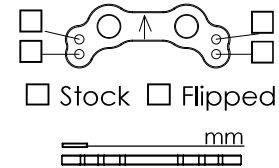
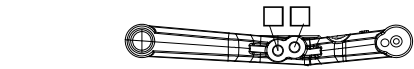
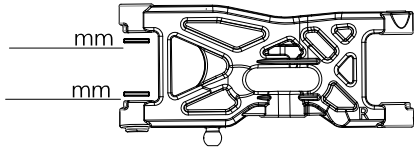
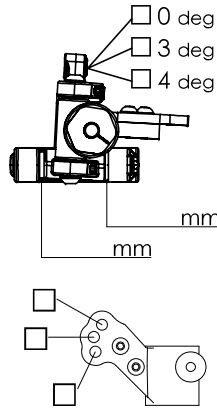
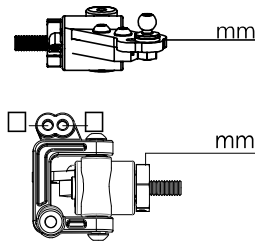
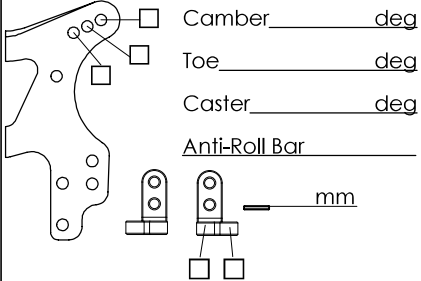

Shock Oil _____

Shock Piston _____

Spring _____

Preload _____ mm

O-Ring Blue Red

Limiters

Inside _____ mm

Outside _____ mm

Notes

Rear Suspension

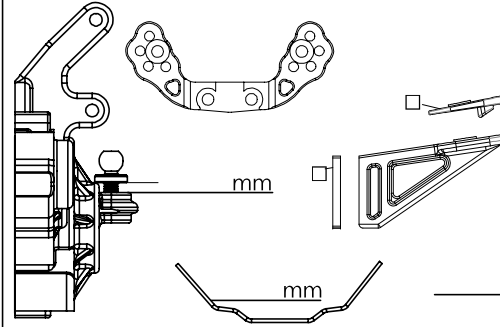
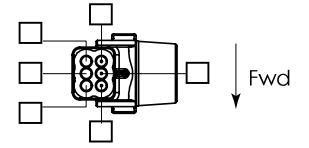
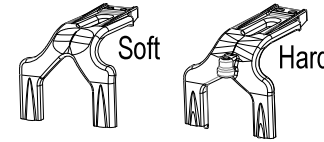
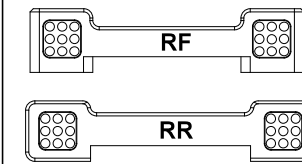
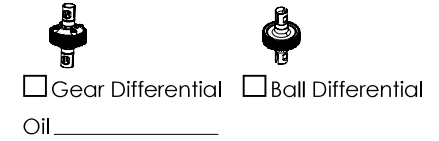
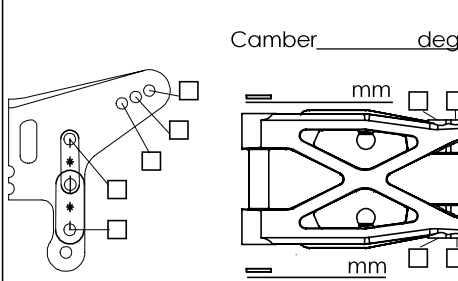

Shock Oil _____

Shock Piston _____

Spring _____

Preload _____ mm

O-Ring Blue Red

Limiters

Inside _____ mm

Outside _____ mm

Notes

Tires & Wheels

Front Tire _____	Rear Tire _____
Wheel _____	Wheel _____
Inserts _____	Inserts _____

Notes

Battery Position

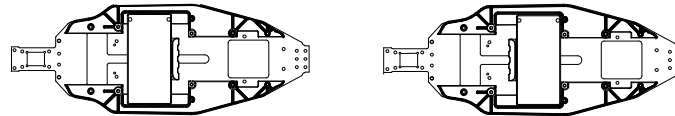

Temp

Track Conditions

Composition: Astro Carpet Clay Dirt Grass

Layout: Open Mixed Tight

Traction: Low Medium High

Surface: Smooth Bumpy

Humidity

Others

ESC _____

Motor _____

Battery _____

Pinion/Spur _____

Wing _____