

Name \_\_\_\_\_

Date \_\_\_\_\_

Track / City \_\_\_\_\_

Event \_\_\_\_\_

### Front Suspension

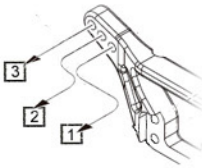

Spacer: \_\_\_\_\_ mm



Bellcrank Spacer: \_\_\_\_\_ mm

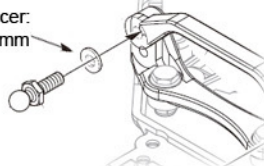

Camber Angle: \_\_\_\_\_ °  
 Toe Angle: \_\_\_\_\_ °  
 Ride Height: \_\_\_\_\_  
 Sway Bar: \_\_\_\_\_

Suspension Holder Spacer:

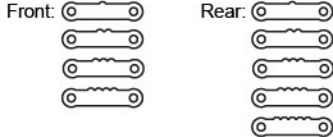

Notes: \_\_\_\_\_

Ball stud position:  
 Stock  
 Kingpin

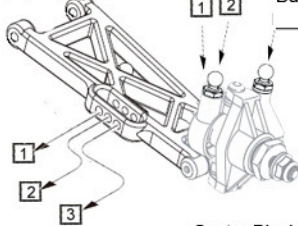

Hub Spacer: \_\_\_\_\_ mm

Bump Steer Spacer: \_\_\_\_\_ mm

Knuckle  
 Standard  
 Opposite

Axle Height Spacer:  
 Up  
 Down

Hex Spacer: \_\_\_\_\_ mm

Caster Block:  
 7°  
 10°

Shock Piston: \_\_\_\_\_  
 Shock Oil: \_\_\_\_\_  
 Shock Spring: # \_\_\_\_\_

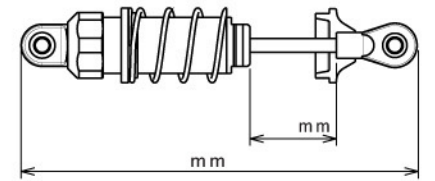

### Rear Suspension

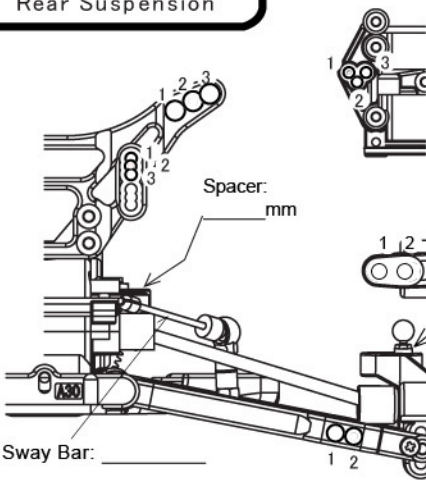

Spacer: \_\_\_\_\_ mm

Suspension Holder:

Front: \_\_\_\_\_

Rear: \_\_\_\_\_

Suspension Holder Spacer:

Front: \_\_\_\_\_ Rear: \_\_\_\_\_

\_\_\_\_\_

\_\_\_\_\_

\_\_\_\_\_

Hub Carrier Spacer: \_\_\_\_\_ mm

Hub Carrier  
 2°  
 0°

Hub Carrier Height  
 Up  
 Middle  
 Down

Hex Spacer: \_\_\_\_\_ mm

Wheelbase  
 Short  
 Medium  
 Long

Camber Angle: \_\_\_\_\_ °

Sway Bar: \_\_\_\_\_

Ride Height: \_\_\_\_\_

Notes: \_\_\_\_\_

Shock Piston: \_\_\_\_\_  
 Shock Oil: \_\_\_\_\_  
 Shock Spring: # \_\_\_\_\_

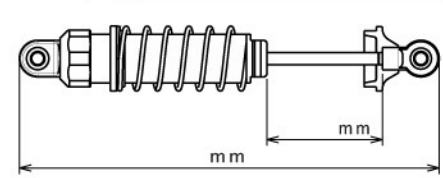

Arm0 at petitrc.com

### Tire

Front Tire \_\_\_\_\_

Rear Tire \_\_\_\_\_

Front Inserts \_\_\_\_\_

Rear Inserts \_\_\_\_\_

### Compound

### Others

Motor \_\_\_\_\_

Pinion/Spur \_\_\_\_\_ / \_\_\_\_\_

Wing \_\_\_\_\_

Wing Angle  0°  4°  7°

### Center Shaft

Oneway

Direct

### Slipper Sheet

Red-White

Red-Red

White-White

### Track Condition

Smooth

Bumpy

Low Traction

Med Traction

High Traction

Dry

Wet

Dusty

Indoor

Outdoor

### Spring Rate

#50	Black	#68	Blue
#55	Orange	#70	Silver
#60	Orange Yellow	#75	Light Green
#65	Yellow	#80	Green

### Gear Ratio

Secondary Gear Ratio 2.5 (16:40)

	16	17	18	19	20	21	22	23	24	25
76	/	11.18	10.56	10.00	9.50	9.05	8.64	8.26	7.92	7.60
78	12.19	11.47	10.83	10.26	9.75	9.29	8.86	8.48	8.13	7.80

### Shock Piston

Soft ← → Hard

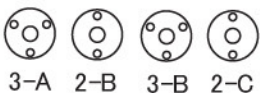

Notes: \_\_\_\_\_

### Sway Bar

1.0	Nickel
1.1	Gold
1.2	Silver
1.3	Copper
1.4	Black
1.5	Golden
1.6	Chromium

### ESC & Battery

ESC: \_\_\_\_\_

ESC Settings: \_\_\_\_\_

Battery: \_\_\_\_\_

Battery Position:

Front

Rear

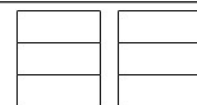

### Comments