

Name \_\_\_\_\_

Date \_\_\_\_\_

Track / City \_\_\_\_\_

Event \_\_\_\_\_

### Front Suspension

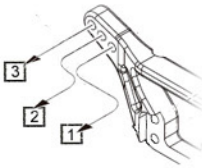

Spacer: \_\_\_\_\_ mm



Bellcrank Spacer: \_\_\_\_\_ mm

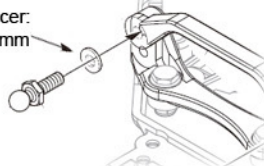

Camber Angle: \_\_\_\_\_ °  
 Toe Angle: \_\_\_\_\_ °  
 Ride Height: \_\_\_\_\_  
 Sway Bar: \_\_\_\_\_

Suspension Holder Spacer:

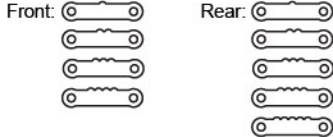

Notes: \_\_\_\_\_

Ball stud position:  
 Stock  
 Kingpin

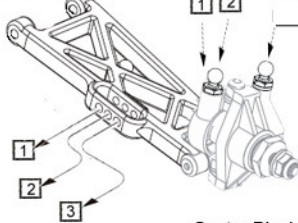

Hub Spacer: \_\_\_\_\_ mm

Bump Steer Spacer: \_\_\_\_\_ mm

Knuckle  
 Standard  
 Opposite

Axle Height Spacer:  
 Up  
 Down

Hex Spacer: \_\_\_\_\_ mm

Caster Block:  
 7°  
 10°

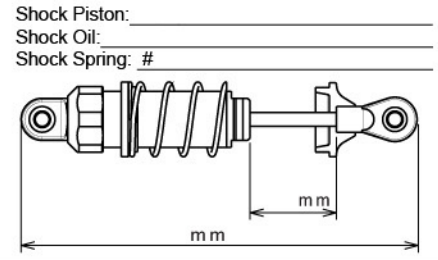

Shock Piston: \_\_\_\_\_  
 Shock Oil: \_\_\_\_\_  
 Shock Spring: # \_\_\_\_\_

### Rear Suspension

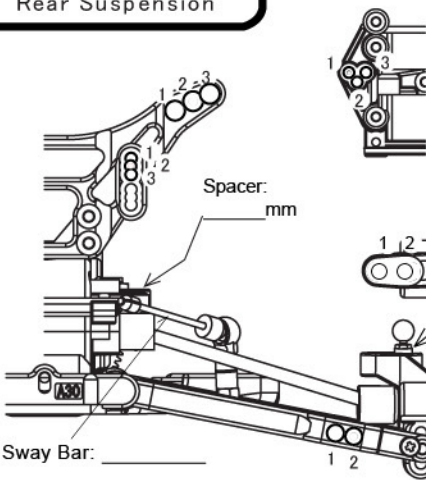

Spacer: \_\_\_\_\_ mm

Suspension Holder:

Front: \_\_\_\_\_

Rear: \_\_\_\_\_

Suspension Holder Spacer:

Front: \_\_\_\_\_ Rear: \_\_\_\_\_

\_\_\_\_\_

\_\_\_\_\_

\_\_\_\_\_

\_\_\_\_\_

Notes: \_\_\_\_\_

Hub Carrier Spacer: \_\_\_\_\_ mm

Hub Carrier

2°  
 0°

Hub Carrier Height

Up  
 Middle  
 Down

Hex Spacer: \_\_\_\_\_ mm

Wheelbase  
 Short  
 Medium  
 Long

Sway Bar: \_\_\_\_\_

Ride Height: \_\_\_\_\_

Camber Angle: \_\_\_\_\_ °

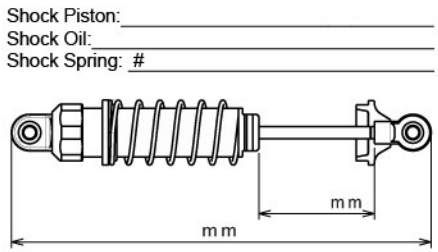

Shock Piston: \_\_\_\_\_  
 Shock Oil: \_\_\_\_\_  
 Shock Spring: # \_\_\_\_\_

Arm0 at petitrc.com

### Tire

Front Tire \_\_\_\_\_

Rear Tire \_\_\_\_\_

Front Inserts \_\_\_\_\_

Rear Inserts \_\_\_\_\_

### Compound

### Others

Motor \_\_\_\_\_

Pinion/Spur \_\_\_\_\_ / \_\_\_\_\_

Wing \_\_\_\_\_

Wing Angle  0°  4°  7°

### Center Shaft

Oneway

Direct

### Slipper Sheet

Red-White

Red-Red

White-White

### Track Condition

Smooth

Bumpy

Low Traction

Med Traction

High Traction

Dry

Wet

Dusty

Indoor

Outdoor

### Spring Rate

|     |               |     |             |
|-----|---------------|-----|-------------|
| #50 | Black         | #68 | Blue        |
| #55 | Orange        | #70 | Silver      |
| #60 | Orange Yellow | #75 | Light Green |
| #65 | Yellow        | #80 | Green       |

### Gear Ratio

|    |  | Secondary Gear Ratio 2.5 (16:40) |       |       |       |      |      |      |      |      |      |
|----|--|----------------------------------|-------|-------|-------|------|------|------|------|------|------|
|    |  | 16                               | 17    | 18    | 19    | 20   | 21   | 22   | 23   | 24   | 25   |
| 76 |  | /                                | 11.18 | 10.56 | 10.00 | 9.50 | 9.05 | 8.64 | 8.26 | 7.92 | 7.60 |
| 78 |  | 12.19                            | 11.47 | 10.83 | 10.26 | 9.75 | 9.29 | 8.86 | 8.48 | 8.13 | 7.80 |

### Shock Piston

Soft ← → Hard

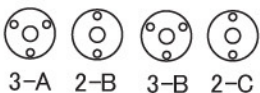

Notes: \_\_\_\_\_

### Sway Bar

|     |          |
|-----|----------|
| 1.0 | Nickel   |
| 1.1 | Gold     |
| 1.2 | Silver   |
| 1.3 | Copper   |
| 1.4 | Black    |
| 1.5 | Golden   |
| 1.6 | Chromium |

### ESC & Battery

ESC: \_\_\_\_\_

ESC Settings: \_\_\_\_\_

Battery: \_\_\_\_\_

Battery Position:

Front

Rear

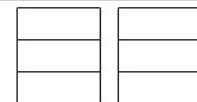

### Comments