

Name _____

Date _____

Track / City _____

Event _____

Front Suspension

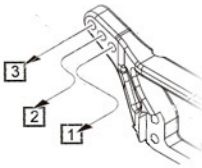

Spacer: _____ mm



Bellcrank Spacer: _____ mm

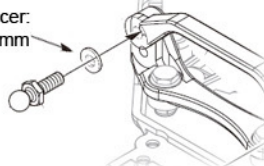

Camber Angle: _____ °
 Toe Angle: _____ °
 Ride Height: _____
 Sway Bar: _____

Suspension Holder Spacer:

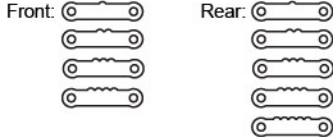

Notes: _____

Ball stud position:
 Stock
 Kingpin

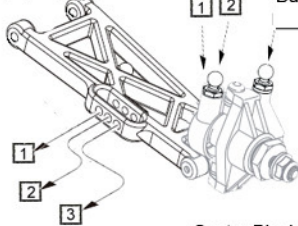

Hub Spacer: _____ mm

Bump Steer Spacer: _____ mm

Knuckle
 Standard
 Opposite

Axle Height Spacer:
 Up
 Down

Hex Spacer: _____ mm

Caster Block:
 7°
 10°

Shock Piston: _____
 Shock Oil: _____
 Shock Spring: # _____

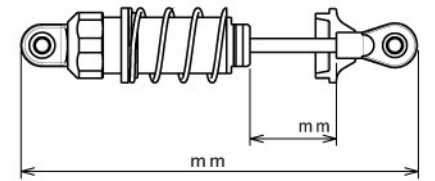

Rear Suspension

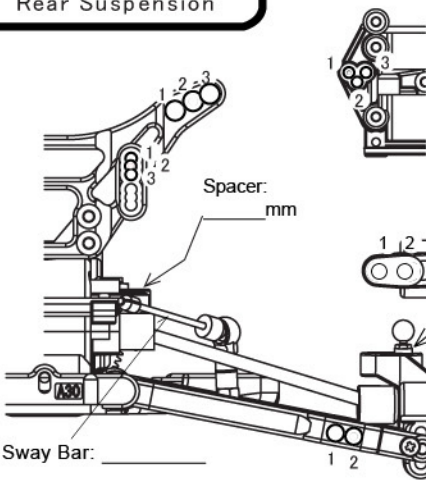

Spacer: _____ mm

Suspension Holder:

Front: _____

Rear: _____

Suspension Holder Spacer:

Front: _____ Rear: _____

Hub Carrier Spacer: _____ mm

Hub Carrier
 2°
 0°

Hub Carrier Height
 Up
 Middle
 Down

Hex Spacer: _____ mm

Wheelbase
 Short
 Medium
 Long

Camber Angle: _____ °

Ride Height: _____

Sway Bar: _____

Notes: _____

Shock Piston: _____
 Shock Oil: _____
 Shock Spring: # _____

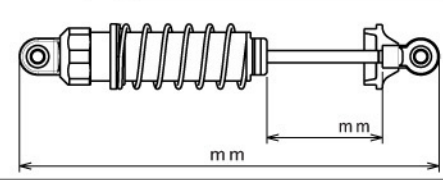

Arm0 at petitrc.com

Tire

Front Tire _____
 Rear Tire _____
 Front Inserts _____
 Rear Inserts _____

Compound

Others

Motor _____
 Pinion/Spur _____ / _____
 Wing _____
 Wing Angle 0° 4° 7°

Center Shaft
 Oneway
 Direct

Slipper Sheet
 Red-White
 Red-Red
 White-White

Track Condition

Smooth Dry
 Bumpy Wet
 Low Traction Dusty
 Med Traction Indoor
 High Traction Outdoor

Spring Rate

| | | | |
|-----|---------------|-----|-------------|
| #50 | Black | #68 | Blue |
| #55 | Orange | #70 | Silver |
| #60 | Orange Yellow | #75 | Light Green |
| #65 | Yellow | #80 | Green |

Gear Ratio

Secondary Gear Ratio 2.5 (16:40)

| | | | | | | | | | | |
|----|-------|-------|-------|-------|------|------|------|------|------|------|
| | 16 | 17 | 18 | 19 | 20 | 21 | 22 | 23 | 24 | 25 |
| 76 | / | 11.18 | 10.56 | 10.00 | 9.50 | 9.05 | 8.64 | 8.26 | 7.92 | 7.60 |
| 78 | 12.19 | 11.47 | 10.83 | 10.26 | 9.75 | 9.29 | 8.86 | 8.48 | 8.13 | 7.80 |

Shock Piston

Soft ← → Hard

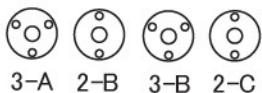

Notes: _____

Sway Bar

| | |
|-----|----------|
| 1.0 | Nickel |
| 1.1 | Gold |
| 1.2 | Silver |
| 1.3 | Copper |
| 1.4 | Black |
| 1.5 | Golden |
| 1.6 | Chromium |

ESC & Battery

ESC: _____
 ESC Settings: _____

Battery: _____

Battery Position:

Front
 Rear

| | |
|--|--|
| | |
| | |
| | |

Comments