

Name _____

Date _____

Track / City _____

Event _____

Front Suspension

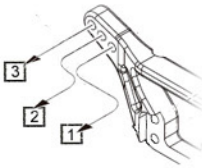

Spacer: _____ mm



Bellcrank Spacer: _____ mm

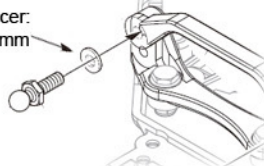

Camber Angle: _____ °
 Toe Angle: _____ °
 Ride Height: _____
 Sway Bar: _____

Suspension Holder Spacer:

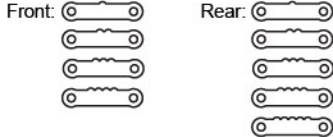

Notes: _____

Ball stud position:
 Stock
 Kingpin

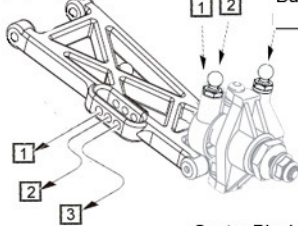

Hub Spacer: _____ mm

Bump Steer Spacer: _____ mm

Knuckle
 Standard
 Opposite

Axle Height Spacer:
 Up
 Down

Hex Spacer: _____ mm

Caster Block:
 7°
 10°

Shock Piston: _____
 Shock Oil: _____
 Shock Spring: # _____

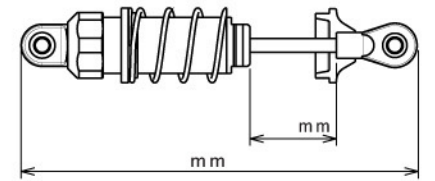

Rear Suspension

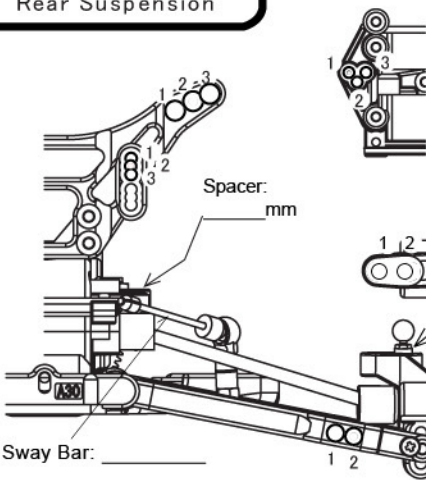

Spacer: _____ mm

Suspension Holder: _____

Front: _____

Rear: _____

Suspension Holder Spacer:

Front: _____ Rear: _____

Hub Carrier Spacer: _____ mm

Hub Carrier
 2°
 0°

Hub Carrier Height
 Up
 Middle
 Down

Hex Spacer: _____ mm

Wheelbase
 Short
 Medium
 Long

Sway Bar: _____

Ride Height: _____

Camber Angle: _____ °

Notes: _____

Shock Piston: _____
 Shock Oil: _____
 Shock Spring: # _____

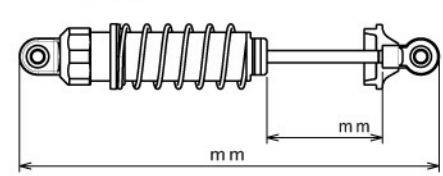

Arm0 at petitrc.com

Tire

Front Tire _____
 Rear Tire _____
 Front Inserts _____
 Rear Inserts _____

Compound

Others

Motor _____
 Pinion/Spur _____ / _____
 Wing _____
 Wing Angle 0° 4° 7°

Center Shaft
 Oneway
 Direct

Slipper Sheet
 Red-White
 Red-Red
 White-White

Track Condition

Smooth Dry
 Bumpy Wet
 Low Traction Dusty
 Med Traction Indoor
 High Traction Outdoor

Spring Rate

#50	Black	#68	Blue
#55	Orange	#70	Silver
#60	Orange Yellow	#75	Light Green
#65	Yellow	#80	Green

Gear Ratio

Secondary Gear Ratio 2.5 (16:40)

	16	17	18	19	20	21	22	23	24	25
76	/	11.18	10.56	10.00	9.50	9.05	8.64	8.26	7.92	7.60
78	12.19	11.47	10.83	10.26	9.75	9.29	8.86	8.48	8.13	7.80

Shock Piston

Soft ← → Hard

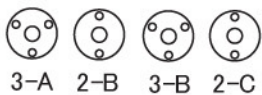

Notes: _____

Sway Bar

1.0	Nickel
1.1	Gold
1.2	Silver
1.3	Copper
1.4	Black
1.5	Golden
1.6	Chromium

ESC & Battery

ESC: _____
 ESC Settings: _____

Battery: _____

Battery Position:

Front
 Rear

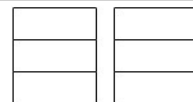

Comments