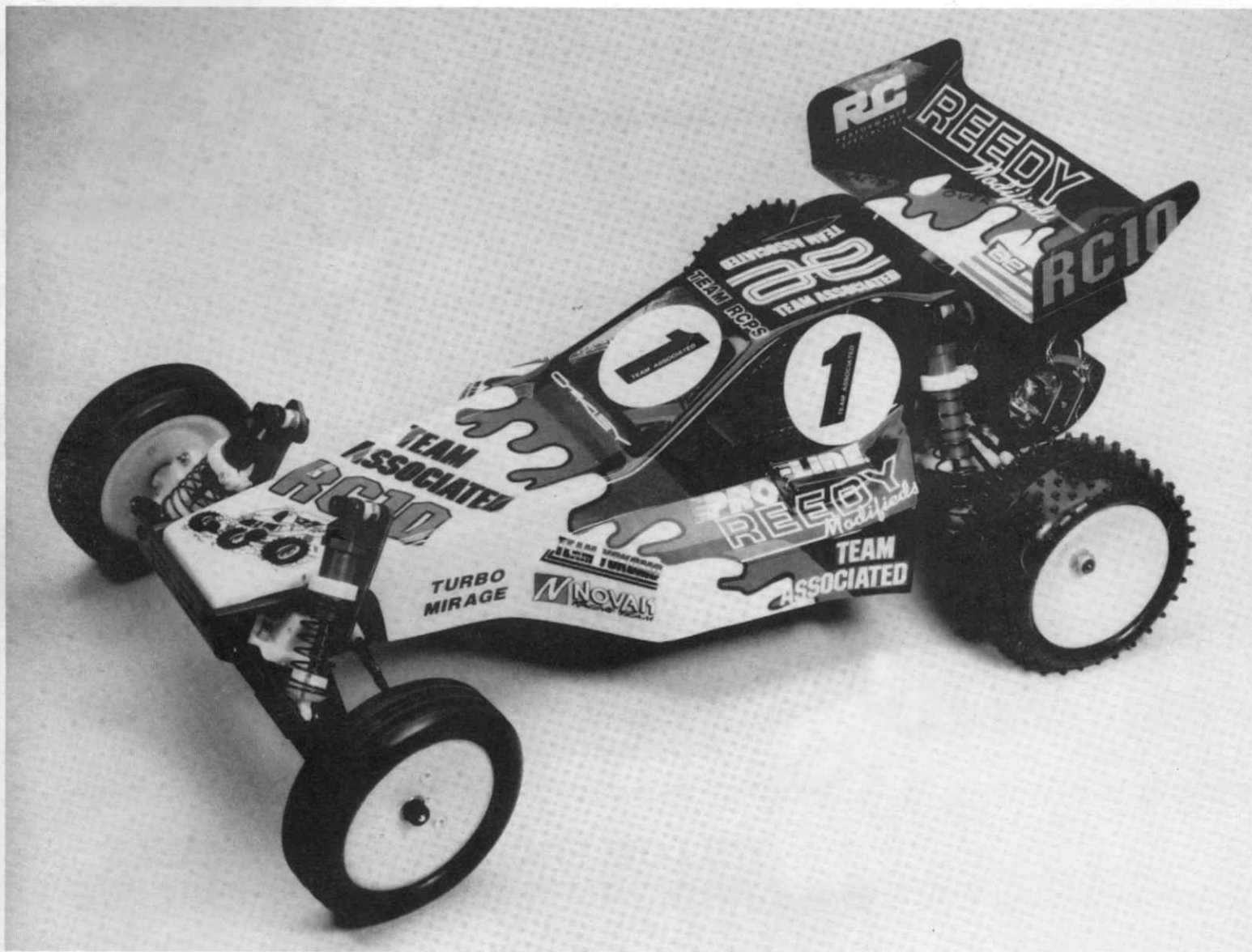


WORLD'S CAR

#6037 1:10 SCALE OFF ROAD KIT INSTRUCTION MANUAL



DO NOT DISCARD THIS MANUAL!

Save for future, hassle-free re-ordering of parts

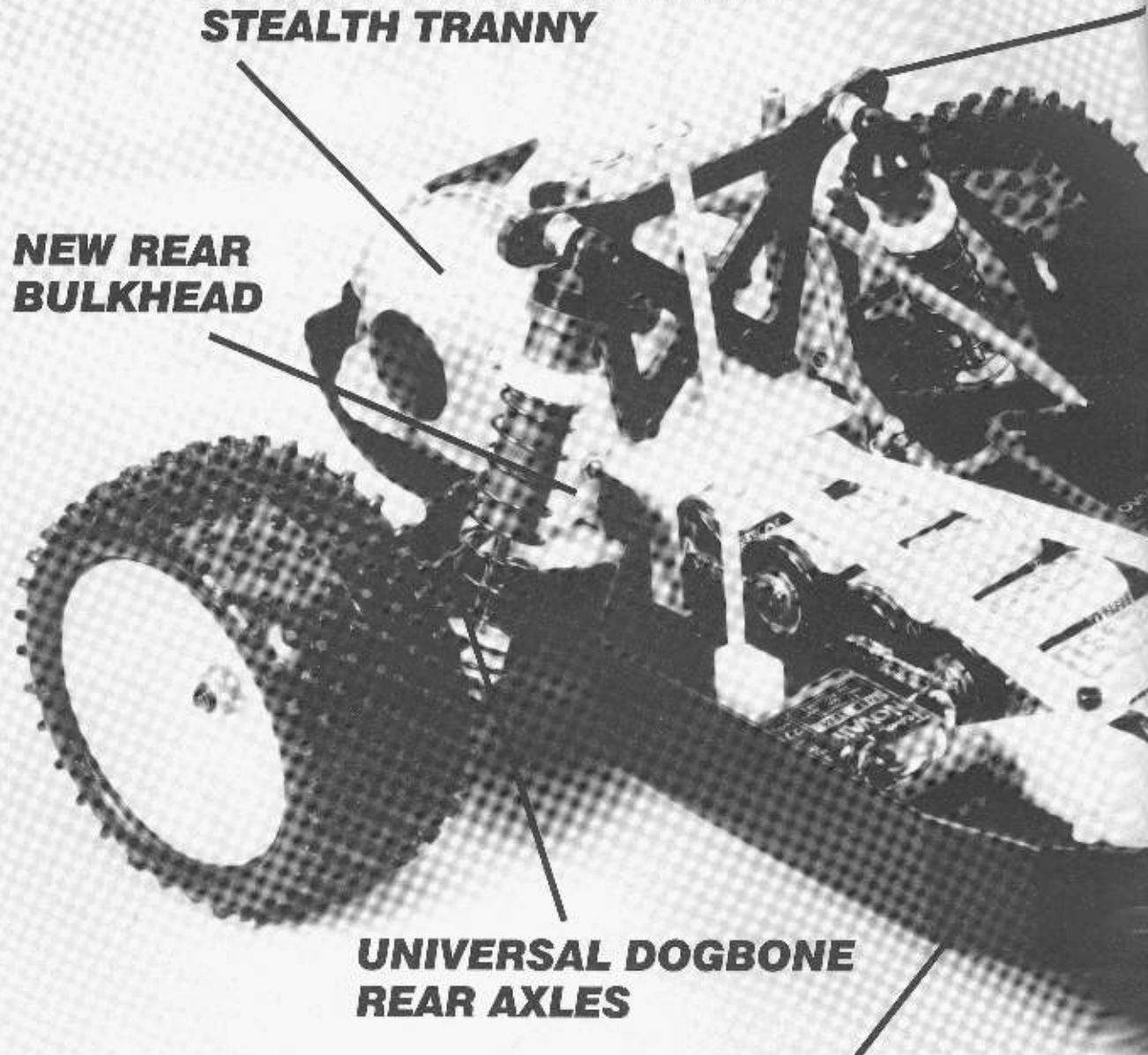
TEAM ASSOCIATED

Associated Electrics, Inc.
3585 Cadillac Ave.
Costa Mesa, CA 92626



**CHAMPIONSHIP-WINNING
STEALTH TRANNY**

**NEW REAR
BULKHEAD**



**UNIVERSAL DOGBONE
REAR AXLES**

**STRONGER, PRE-MILLED,
HARD ANODIZED
ALUMINUM CHASSIS**

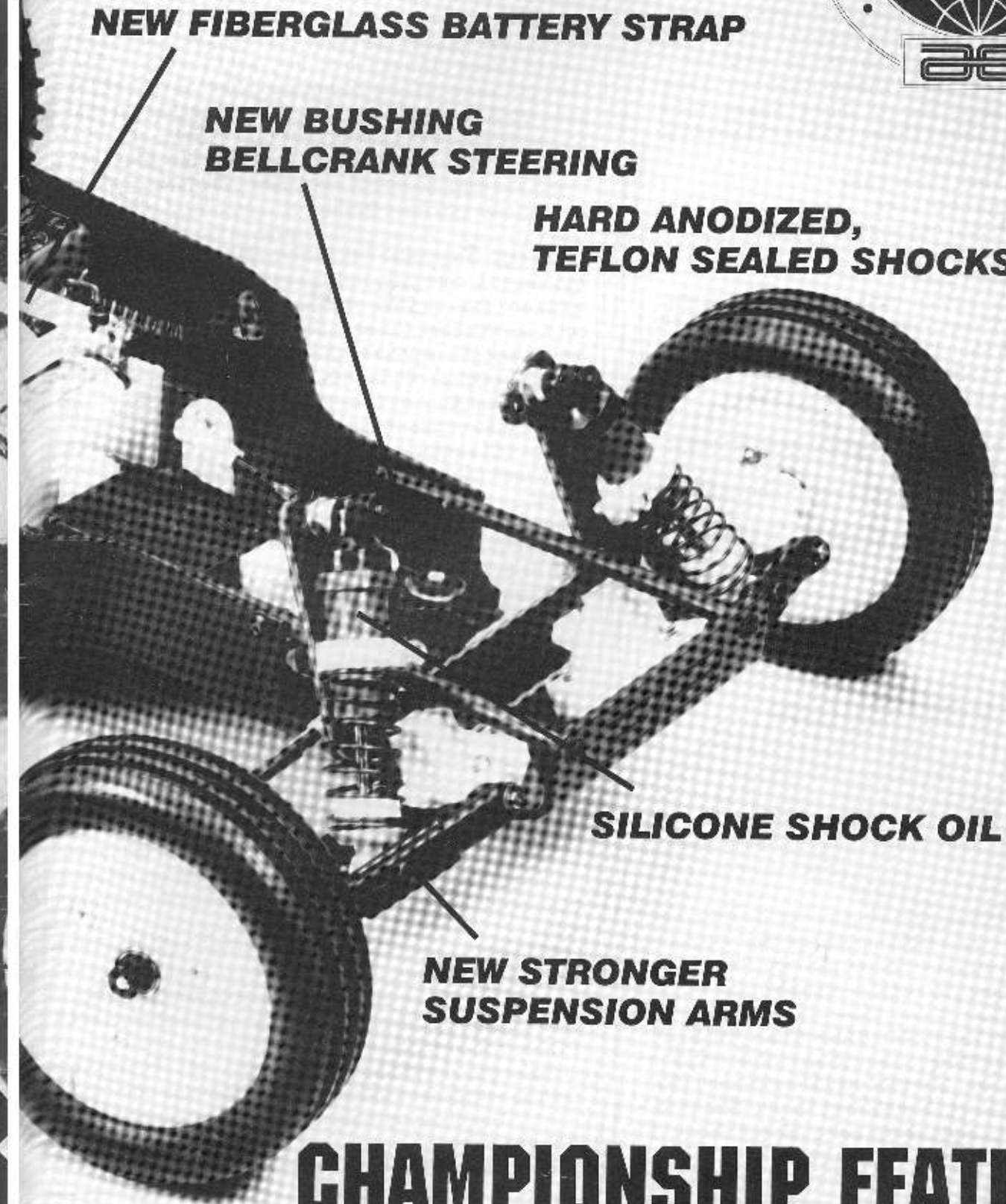
**NEW YELLOW FRONT & REAR WHEELS
WITH PROLINE TIRES & FOAM INSERTS**

**NEW GRAPHITE FRONT & REAR
SHOCK STRUTS**

NEW FIBERGLASS BATTERY STRAP

**NEW BUSHING
BELLCRANK STEERING**

**HARD ANODIZED,
TEFLON SEALED SHOCKS**



SILICONE SHOCK OIL

**NEW STRONGER
SUSPENSION ARMS**

RC10 WORLD'S CAR

CHAMPIONSHIP FEATURES

FIRST, A WORD ABOUT YOUR NEW CAR

Your new RC10 World's Car includes all of the newly designed parts our Team has been using that have helped us win four of the five 1:10 Off Road World Championships ever held. We feel there is no better car available.

As great as the existing Team Car has been, we know we have to continually work at improving our car so we can stay ahead of our competition. This car will show you that we have been busy working on a number of important upgrades. While the new car looks similar to the old car, there are many new changes. The new car starts with a black, hard anodized aluminum chassis made from a new material which is stronger than our original chassis, and it comes with the bottom of the chassis already milled out like our Team uses. It also comes with:

- Graphite front and rear shock struts
- New, stronger, suspension arms
- New rear bulkhead with new adjustment points
- Fiberglass battery strap
- Graphite transmission brace
- New yellow wheels (3 piece fronts with aluminum screws and one piece 2.175" rears) which come with Proline XTR compound tires with foam inserts
- RC Performance Specialities Turbo Mirage Lexan body
- New bushing bellcrank steering
- Silicone shock oil
- 1.02 rear shock shafts and suspension travel limiters for front and rear shocks.
- The car also comes with our Championship-winning Stealth transmission
- Hard anodized Teflon sealed shocks
- Teflon shock pistons
- Aluminum inline front axles
- 30° caster blocks
- Universal dogbone rear axles
- *And more!*

BEFORE YOU BEGIN

You will find the photos so easy to follow that you may be tempted to put the car together from the photos alone. However, although you have the best car kit, if you want the best COMPLETED model race car, then you will want to put it together correctly by following these instructions. All that's required is to read the few lines of text near each photo.

Take your time assembling the car. It's not a race to see how fast you put it together; it's how well you put it together that determines how fast you can race. Please note the steps below before you begin to assemble your kit.

Step 1 OPEN THE PARTS BAGS WHEN THE STEP SPECIFIES, NOT BEFORE, otherwise you will get the parts mixed up and then you will have trouble assembling your car. **When you open each main bag for the first time, check the contents against the parts list** supplied as a separate sheet that came with your manual.

All major parts bags are referred to by number in the manual. While building the car, you will sometimes be working with several bags at the same time. Inside each major parts bags there are more bags; these are not numbered and belong to the bag they came out of.

Step 2 KEEP THE PARTS SEPARATE. While building the car you will sometimes be working with several parts bags at the same time. Bags and parts will start multiplying like rabbits as you build. Try not to confuse parts from one bag with another. A good way to prevent this is to use large paper plates (picnic plates with partitions are the best). They will help you separate the parts and they give you enough area to spread them out in so they will be easier to find. Mark the plates with the bag numbers before you put the parts into them. When the plates are used up you can relabel the plate for another bag.

We have included some miscellaneous spare fasteners and clips, so do not worry when you have parts remaining after you have finished.

Step 3 CHECK THE SUPPLEMENTARY SHEETS. Associated is constantly testing new and improved components and then updating the kit with them when they test out to be beneficial. Not all updates will be noted in the written manual (the manuals cannot be reprinted to keep up with the updates). So before you begin, check each parts bag to see if they contain any supplementary instruction sheets. If so, locate the section of the manual where this change first applies and attach the sheet(s) to that section so you will not forget about the changes when assembling the kit.

Step 4 ADDITIONAL ITEMS NEEDED TO OPERATE THE CAR:

- 2 channel R/C surface radio system.
- Battery pack (6 or 7 cell).
- Battery charger (for 6 and/or 7 cell packs).
- Electronic Speed Control.
- R/C electric motor.
- Servo saver (Assoc. #8435 or #5551, or Kimbrough equivalent). Using this item is optional depending upon steering servo used and your setup preference.
- Motor pinion gear (48 pitch); size will be determined by type and wind of motor being used.

Step 5 TOOLS. Your kit contains the four Allen wrenches and the turnbuckle/shock wrench that you will need to assemble your car kit, but you will still need the following tools:

- #2 Phillips screwdriver (Assoc. #SP-76)
- Needle nose pliers
- Hobby knife, such as a X-acto© with a pointed blade
- Soldering iron (40 to 50 watts) and a small amount of ROSIN (not acid) core 60/40 solder.
- Super glue (instant adhesive)
- Ruler with decimal inches or metric measure

The kit can be assembled faster and easier with the following tools:

Screwdriver handle Allen wrenches from Associated in sizes:

- #6957, .050" ● #6958, 1/16" ● #6961, 2.5mm
- #6959, 5/64" ● #6960, 3/32"
- A 3/16" nut driver will make installing the ball ends and upper arm turnbuckles easier. (#SP-86)
- A 1/4" nut driver will make installing the 4-40 nuts easier. (#SP-85)
- An 11/32" nut driver will make installing and adjusting the 8-32 rear axle diff nut easier. (#SP-82)
- A precision ruler with decimal inches or metric measure.

WARNING! Do not use a power screwdriver to install screws into nylon parts. The rotation speed is too fast, and causes the screws to heat up when being driven into plastic or nylon parts, then strips them out.

Step 6 FINAL NOTES:

(1) For you experienced builders and racers: **please build the car our way first!!** The RC10 Worlds Car is a remarkably fast buggy right out of the box. There's a good reason for everything on the car, and very few compromises were made in its design. If you build it our way first you can see what your car is capable of before you make changes and you will then have a base point to compare against.

(2) Put a check mark in the box () at each step after you finish it. Then when you stop during assembly, it will be easier to find where you need to continue from.

(3) To help you identify certain parts, occasionally an actual-size drawing will accompany the photo. (See example in fig. 2.) You can place your part on top of the drawing to be sure you have picked up the right part. Most likely you will end up with spare parts and fasteners, but this is nothing to worry, about because we have deliberately left you with some spare items.

(4) We have used some special abbreviations throughout this manual for the various types of screws used. The following list identifies what the abbreviations stand for:

- FHMScrew: Flat Head Machine Screw. Standard thread screw which requires a Phillips screwdriver.
- FHSScrew: Flat Head Socket Screw. Standard thread screw which requires a Allen wrench or driver. The same type of tool is used for the two following fasteners:
- BHSScrew: Button Head Socket Screw.
- SHCScrew: Socket Head Cap Screw.

(5) In order to keep a sense of direction when building the car, we use the following descriptions to standardize the right and left sides of the vehicle. The driver's side or left side: with the driver sitting in the driver's seat facing the front of the car, his left hand is the driver's side. The passenger or right side will be the driver's right hand side.

(6) The following types of special instructions, *in italics*, will be used throughout the manual:

● **Racer's Tip:** This is a trick used by some of the Team drivers to improve their car's handling or performance, or simplify its maintenance.

● **Note:** Alternate ways to assemble the kit, including tips for smoothing out difficult assemblies.

● **WARNING!** This alerts you to be careful to prevent damage to parts or use of wrong parts that may reduce performance.

SAVE THIS MANUAL! This is more than an in-

struction manual. It is also a handy supplement to the Team Associated 1:10 scale off road buggy catalog. You can use the manual photos and descriptions to identify part numbers and names to help you order parts. Use the current catalog for pricing.

FRONT END ASSEMBLY

Fig. 1 Read pages four and five entirely before proceeding! We'll start by removing the #6309 black anodized aluminum nose plate from bag #6-4. It will look like fig. 1.

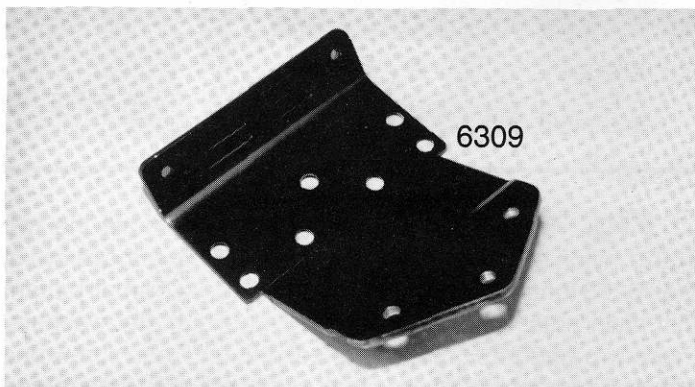
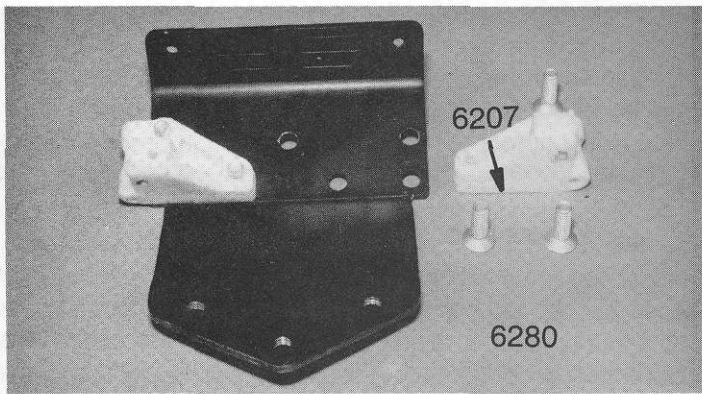


Fig. 1

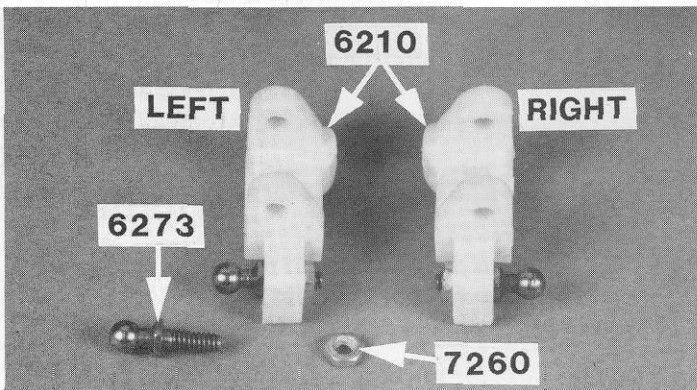
Fig. 2 In bag #6-1 you will find the #6207 front suspension mounts (they are connected by a molding runner) and six #6280 8-32 x 1/2" aluminum FHMScrews. Fig. 2 shows the left side front suspension mount installed. It also shows the right mount and the three #6280 screws used to mount it to the nose plate.




 #6280
8-32 x 1/2
aluminum

Fig. 2

□ **Fig. 3** From bag #6-14 remove two #6273 long ball ends and two #7260 4-40 small thin plain nuts. Now open bag #6-1 and remove the #6210 front carrier blocks. The carrier blocks are connected by a small molded runner which you must remove with your X-acto[®] knife. Be sure to remove ALL of the runner. Screw one of the #6273 ball ends into each carrier block as shown and then thread on the #7260 thin plain nuts. **NOTE:** A 3/16" nut driver will make installing the steel ball ends and small 4-40 nuts easier.

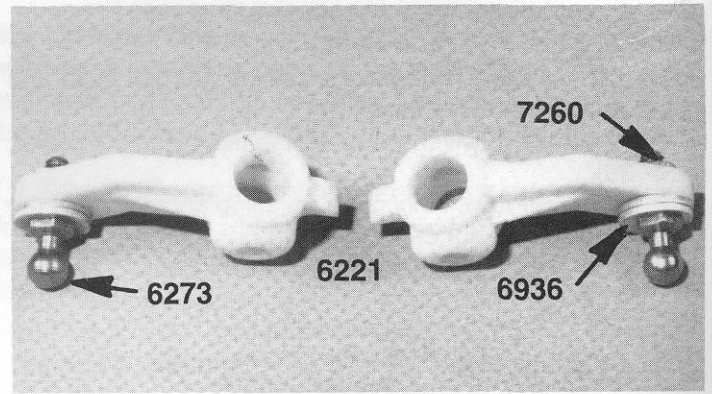


 #7260
4-40
thin plain nut

 #6273
4-40

Fig. 3

□ **Fig. 4** Go to bag #6-1 again and remove the two #6221 nylon steering blocks. From bag #6-14 remove two of the #6273 long steel ball ends, two #7260 4-40 small pattern thin plain nuts, and four #6936 #4 aluminum flat washers. Place two washers onto each steel end and then screw one ball end into each steering block as shown, and then thread on the #7260 4-40 thin plain nut from the back side. Make sure the balls are mounted on opposite sides of the steering blocks so that they both will be on top of the steering blocks when mounted on the car.



 #6936
#4 flat washer
aluminum

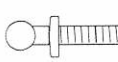

 #6273
4-40

Fig. 4

 #7260
4-40
thin plain nut

□ **Figs. 5 & 6** Remove the two #6220 aluminum inline front axles from bag #6-1 (fig. 6). Install one axle in each #6221 nylon steering blocks (fig. 7), making sure that the hole in each axle lines up with the hole in the steering block. The parts should push together with your fingers; if they don't, fit a 1/4" nut driver over the threaded end of the axle and then push the axle into the steering block. **WARNING!** Threads on the end of the axle are aluminum and can be easily damaged by the nut driver. Repeat the process for the second axle and steering block.

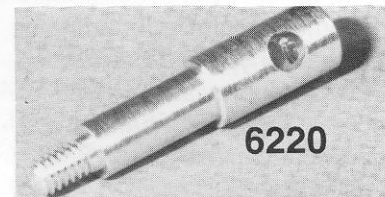


Fig. 5

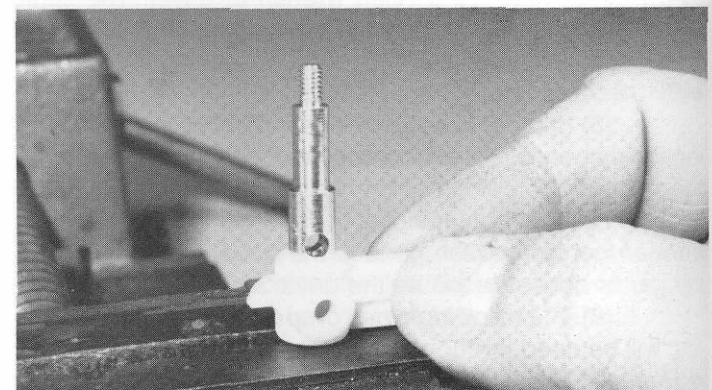


Fig. 6

□ **Fig. 7** The axle is round and will be fairly tight in the steering block, so try to align the hole in the #6220 axle with the hole in the #6221 nylon steering block as you are assembling the parts. **WARNING!** Do not use pliers on the bearing surface of the axle, because this can damage the

axle surface so that the bearings will no longer fit. The larger diameter of the axle will still be sticking out of the steering block slightly; that's okay. Just make sure the holes line up.

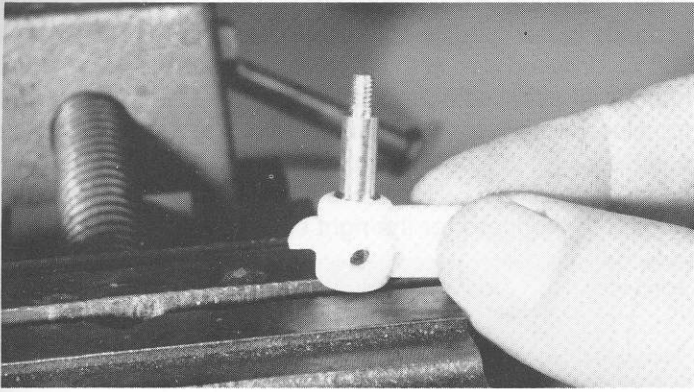
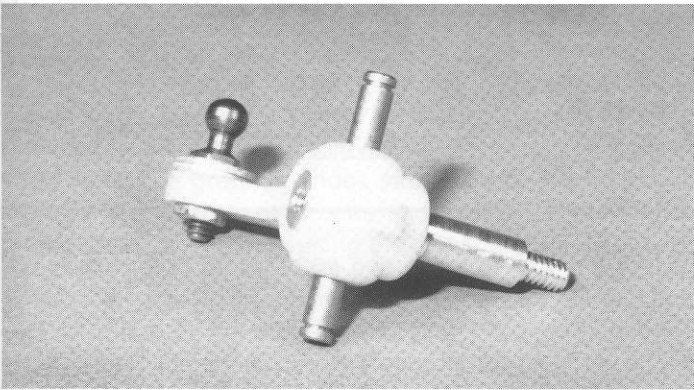


Fig. 7

□ **Fig. 8** In bag #6-1 you will find two #6223 kingpins. This bag contains several different length pins, so match the pins to the actual-size drawing below. Check that each kingpin will go through both steering blocks and axles. If you don't do this, it will be almost impossible to get the kingpin to go through the #6210 carrier block and the steering block and axle when we assemble them. Once you have checked the fit of the kingpins, remove them again.



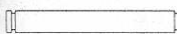
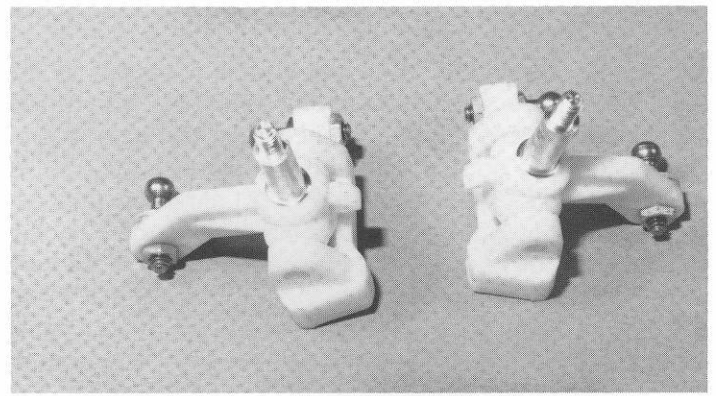
 #6223

Fig. 8

□ **Figs. 9, 10, 11 & 12** Take the two #6210 carrier blocks and install the steering blocks and axles into each one. Both ball ends will be on the same side when installed correctly, and the raised side of the angle on the bottom of the #6210 carrier block will be away from the ball side. Now reinstall one of the #6223 kingpins through each of the carrier block/axle assemblies as shown in figs. 10 and 11. Try to center the kingpins. Fig. 12 shows a package of #6299 1/8" E-clips from bag #6-1. Remove two from the package and install one on each of the kingpin's two grooves. Now take out two more E-clips and install them on the other kingpin.



 #6299
e-clip
1/8 shaft

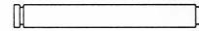
 #6223

Fig. 9

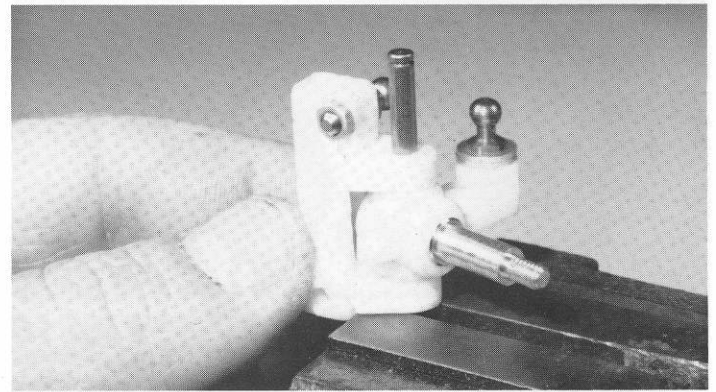


Fig. 10

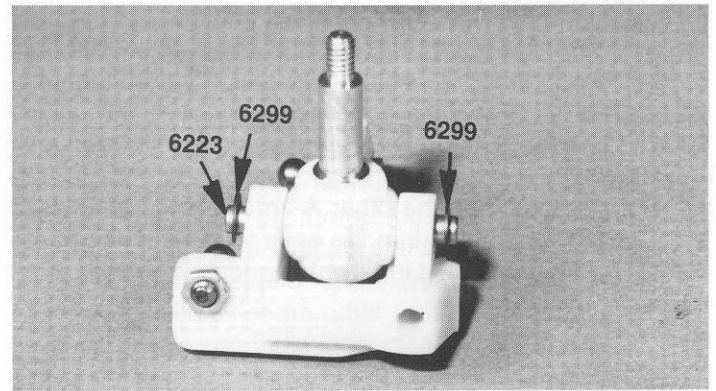


Fig. 11

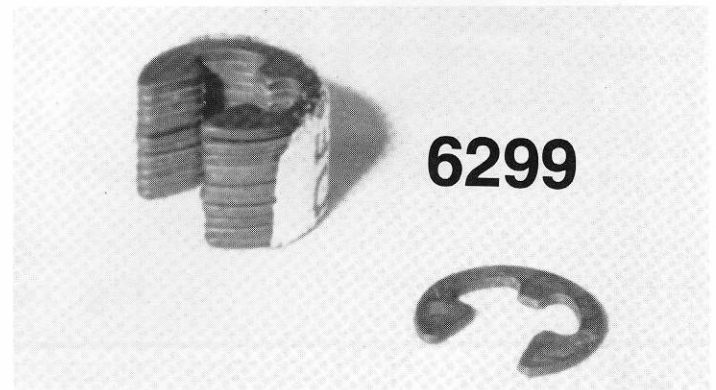
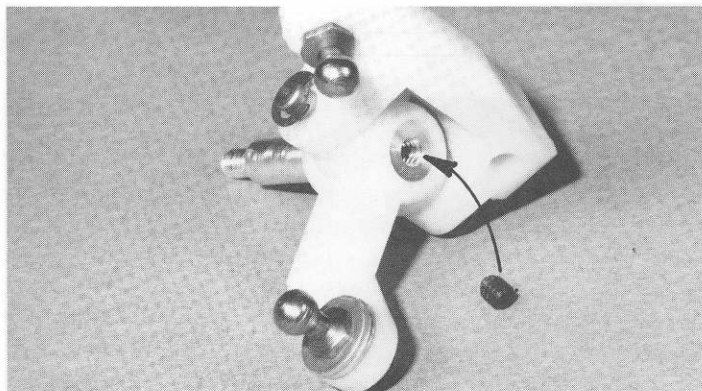


Fig. 12

□ **Fig. 13** In bag #6-1 you will find two small #6951 4-40 x 1/8" set screws. Locate your #6950 tool bag (which contains four sizes of Allen wrenches) in the large master parts bag. Take out the smallest Allen wrench (.050") and install the two set screws into the #6221 aluminum front axles. Rotate the steering blocks in the block carriers so that you can see the threaded hole on the back side of the front axle. Using the same Allen wrench, install the set screw into the back of the front axle until it tightens down on the kingpin as shown in fig. 14. Do the same with the other axle assembly.



□ #6951 set screw

Fig. 13

□ **Fig. 14** Now remove the two #6206 new black front suspension arms from bag #6-1. They are made of stronger material. Removing the parts molding runner is harder than before. The best way to remove the runners from the arms will be to firmly grab the runner with a pair of slip joint pliers where the arm attaches to the runner, and push down with the pliers. When the runner breaks free, do the other three attaching points, then the other A-arm. Now carefully take your X-acto© knife and trim the ends to remove any of the remaining runner so that it will not interfere with suspension travel.

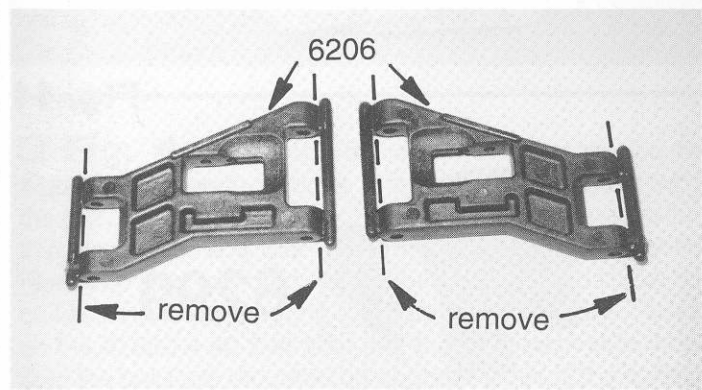
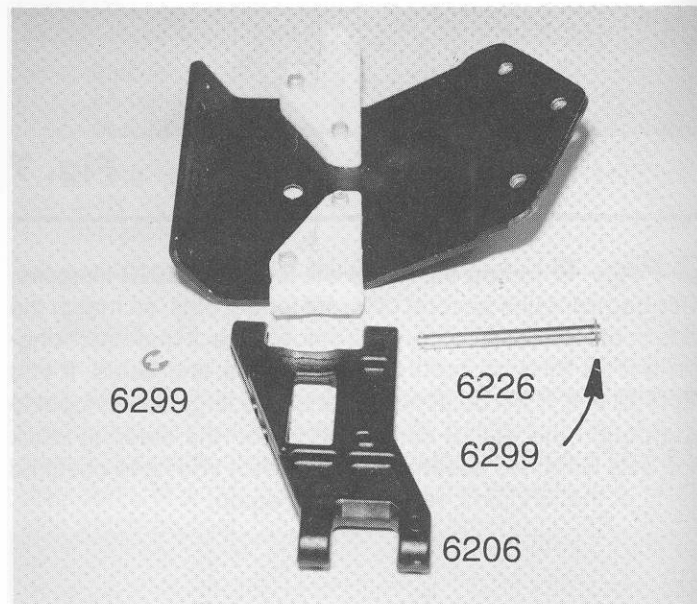


Fig. 14

□ **Fig. 15** Now remove the two #6226 front inner hinge pins and four #6299 1/8" E-clips from bag #6-1. Slip one of the hinge pins into each end of the front suspension arm to

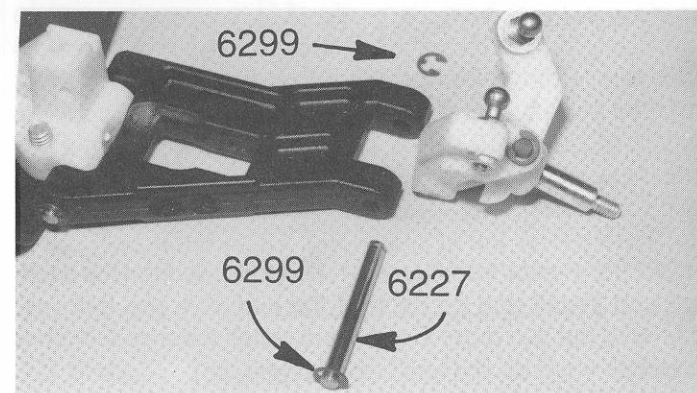
check the pin fit. The A-arm should be able to swing freely on the pin. **Racer's tip:** Most racers keep a .126" straight reamer in their tool box to free up the suspension arm pin holes and to clean them after racing. We DO want the pin to fit tightly in the #6207 front suspension mounts.

Line up one of the #6206 front A-arms with the left hand front suspension mount. Now push one of the #6226 front inner hinge pins through the front of the arm, the mount and then the back of the arm as shown. Use a small screwdriver to push an E-clip into each groove of the hinge pin. Repeat the process for the right side suspension arm.



□ #6299 e-clip 1/8 shaft □ #6226 **Fig. 15**

□ **Fig. 16** Remove two #6227 front outer hinge pins and four #6299 1/8" E-clips from bag #6-1. Now take the left hand steering block and carrier assembly from fig. 10. Line up the left hand carrier/steering block assembly between the outer holes on the left hand front suspension arm. Install the hinge pin through the arm and carrier block. Now install an E-clip into each groove of the pin. Do the same for the right hand parts.



□ #6299 e-clip 1/8 shaft □ #6227 **Fig. 16**

□ **Fig. 17** In bag #6-1 you will find the #6232 new graphite front shock strut. From bag #6-14 remove two #6270 short steel ball ends and two #7260 small 4-40 plain nuts. Thread the ball ends into the graphite shock strut (see fig. 18) and then thread the plain nuts onto the ball ends.

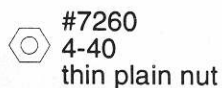
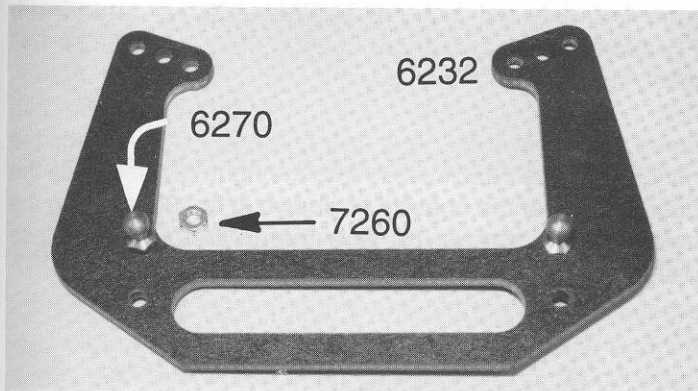


Fig. 17

□ **Figs. 18 & 19** From bag #6-10 remove two #6927 4-40 x 3/4" SHCScrews, two #6936 #4 aluminum washers, and two #6295 4-40 plain nuts. Then from bag #6-1 remove two #6925 4-40 x 1/2" SHCScrews. Thread the two #6927 4-40 x 3/4" SHCScrews into the middle of the three holes on the top of the shock strut. The heads of these screws will be on the same side as the #6270 steel ball ends. Slip the washer then the nut on the screw. Now do the second screw. Now line up the graphite shock strut with the back side of the front suspension mounts as shown. Fasten the shock strut to the #6207 mounts using the two #6925 SHCScrews.

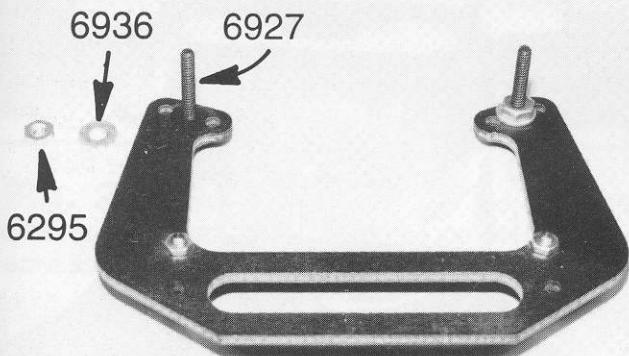


Fig. 18

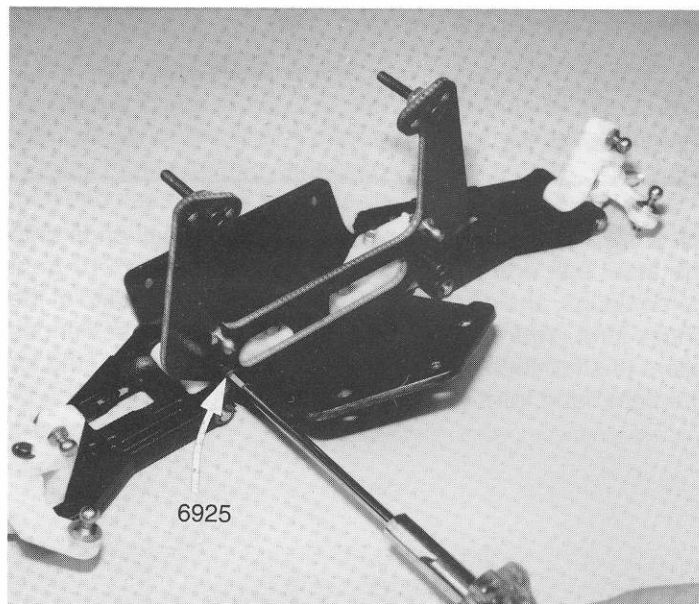
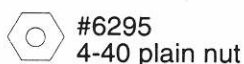
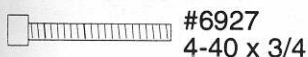


Fig. 19

□ **Fig. 20** In bag #6-1 you will find two #6262 1.65" long turnbuckles and in bag #6-14 the #6274 plastic ball end cap molded tree. Remove four of the plastic ball end caps and thread them onto the two turnbuckles. The plastic ball end caps on both ends will face the same direction. **Note:** Each turnbuckle rod has right hand threads on one end and left hand threads on the other, so the plastic end caps will thread on in opposite directions on each end.

Make sure you thread on the #6274 plastic ball ends evenly so that you will have maximum adjustment range. Adjust your plastic ball ends until they are 2.14" (2 9/64" or 54.40mm) from the center of the ball end hole to the center of the other ball end hole. **Note:** If you overtighten the plastic ball end caps onto the turnbuckles, you will push the turnbuckles into the ball end holes and the plastic ball end caps will be damaged beyond repair. This turnbuckle measurement, along with all of the other turnbuckle measurements still to come, are just preliminary measurements. We will fine tune the adjustments at the end of the instruction manual.

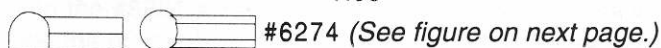
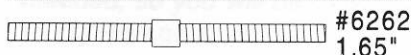
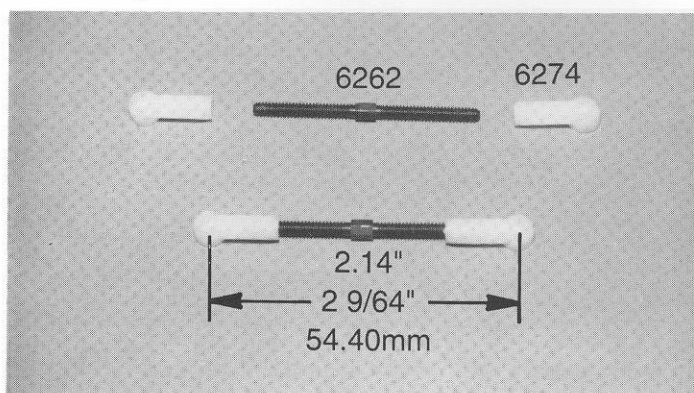
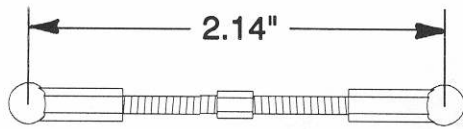


Fig. 20



(dimension for fig. 20)

□ **Fig. 21** Snap the plastic turnbuckle ball ends onto the steel ball end on the top of the left hand #6210 front carrier block, and on the steel ball end on the left hand of the shock strut. You will probably have to use your needlenose pliers to snap them on. Now go ahead and do the same for the right hand turnbuckle assembly.

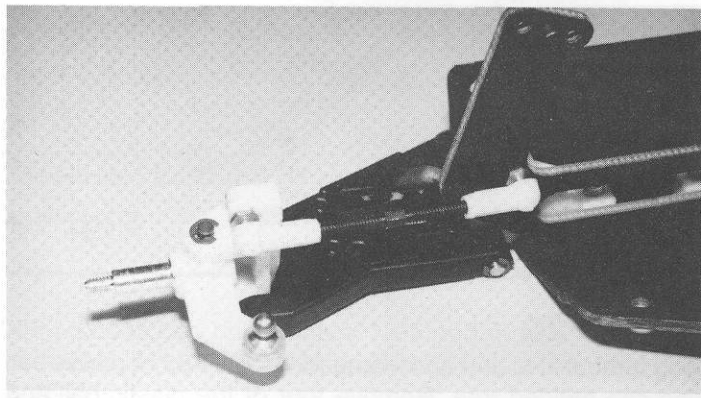


Fig. 21

□ **Fig. 22** The turnbuckle tie rods can be easily removed by carefully holding the plastic ball end with your needlenose pliers (next to the ball) and twisting the plastic rod end off of the steel ball.

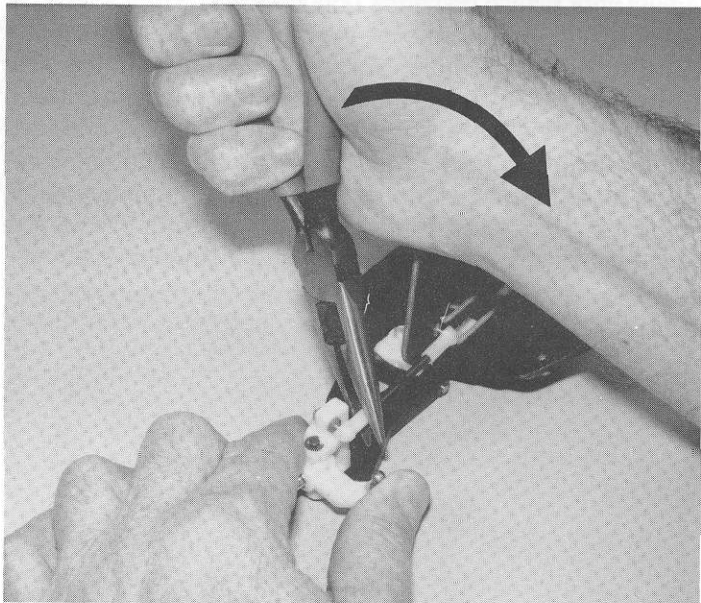
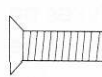
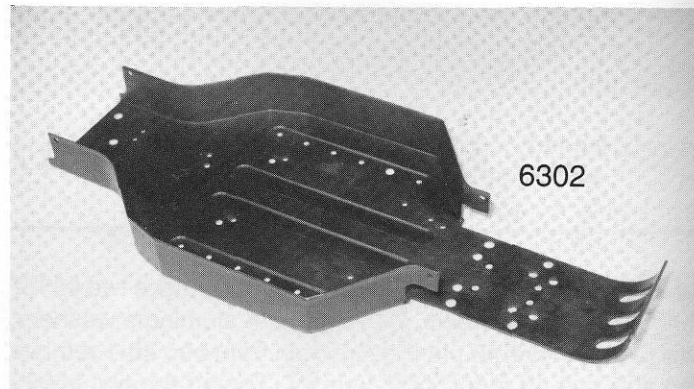


Fig. 22

□ **Figs. 23, 24 & 25** Now we'll attach the #6309 nose plate assembly to the new #6302 black hard anodized aluminum chassis. You will see that your chassis (fig. 23) has already been milled the same as used by our Team drivers. In bag #6-2 you will find one #6280 8-32 x 1/2" aluminum FHMScrew, one #6281 8-32 x 7/8" aluminum FHMScrew. In bag #6-4 you will find one #6931 8-32 x 1/4" steel FHMScrew

(1) Looking from the back of the chassis (fig. 24), insert the #6280 screw into the left, the #6931 screw into the middle, and the #6281 screw into the right. (2) Now slide the nose plate over the chassis as shown in fig. 24, aligning the holes with the screws. (3) Now thread them into the nose plate until they are as in fig. 25.

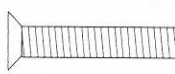
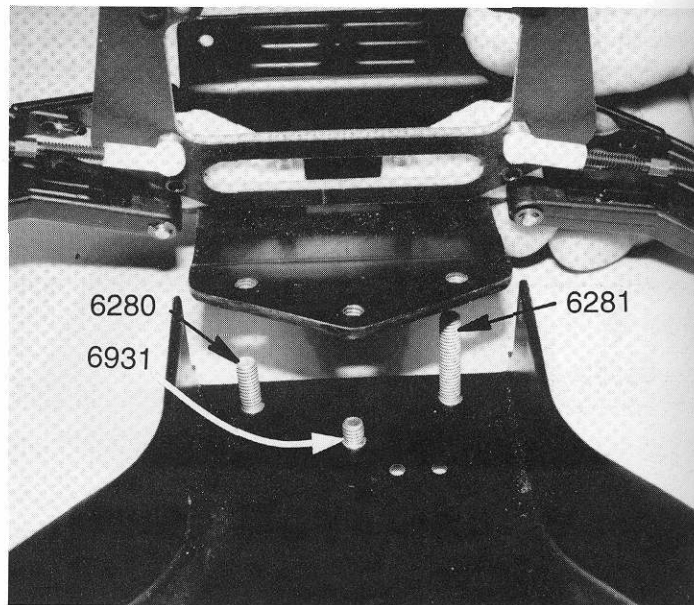


#6280
8-32 x 1/2
aluminum



#6931
8-32 x 1/4
steel

Fig. 23



#6281
8-32 x 7/8
aluminum

Fig. 24

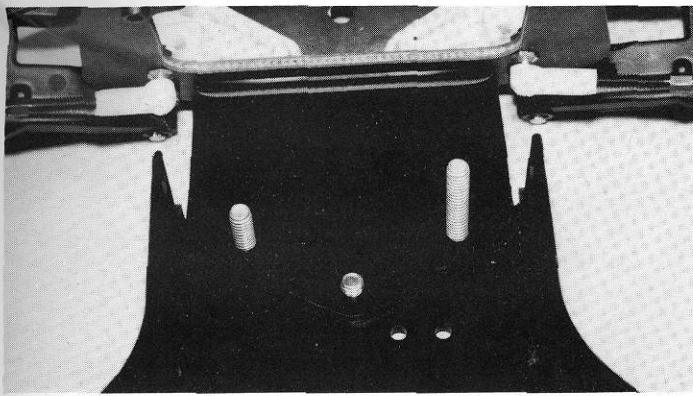
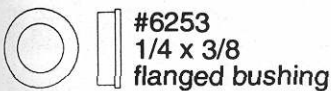


Fig. 25

□ **Fig. 26** Now go back to bag #6-2 and remove the four #6253 1/4" x 3/8" flanged bronze bushings, and two #6254 nylon bell crank steering arms with their nylon sleeve nut inserts. **Note:** Your production #6254 bell crank steering parts will be white, not black, as shown in the photos. Press one of the #6253 bronze bushings into each side of the two steering arms. **Note:** #6252 is a complete bell crank steering replacement kit.



#6253
1/4 x 3/8
flanged bushing

Fig. 26

□ **Fig. 27** In bag #6-14 you will find five #6270 short steel ball ends. Thread the ball ends into the bell crank steering arms as shown. No nuts are needed for these ball ends.



#6270
4-40

Fig. 27

□ **Fig. 28** Remove the two #6263 2.06" length turnbuckles and one #6260 1.0" turnbuckle from bag #6-2. Now remove six of the #6274 plastic ball end caps from bag #6-14 and thread them evenly onto the turnbuckles. The plastic ball end caps will all face the same way on these turnbuckles.

Adjust the length of the small turnbuckle from center of ball hole to center of ball hole to 1.47" (1 15/32" or 37.5mm). Then adjust the two longer steering turnbuckles to 2.51" (2 1/2" or 63.75mm) center to center length.

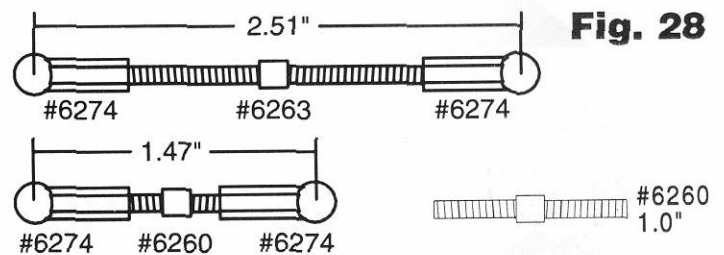
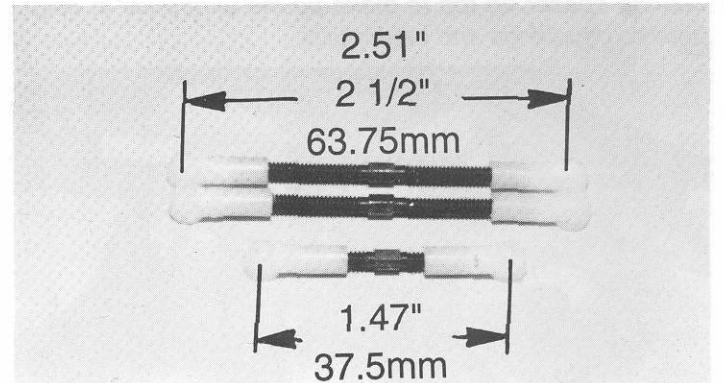


Fig. 28

□ **Fig. 29** Take the short turnbuckle tie rod and snap it onto the bell crank steering arms as shown. You may need to use pliers.

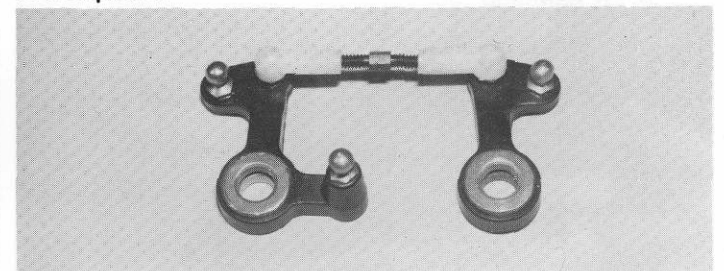


Fig. 29

□ **Fig. 30** (1) Install the #6254 bell crank steering assembly loosely over the two aluminum screws that are holding the nose plate to the chassis. (2) Next, thread the two #6254 nylon sleeve insert nuts (from fig. 26) onto the #6280 and #6281 aluminum screws. **Note:** The sleeve nut is not threaded, so you will be making your own threads as you go. (3) Now go ahead and thread the right hand sleeve nut onto the #6281 screw. Make sure it lines up and slides inside the bushings of the right hand bell crank steering arm as it goes down. (4) Then lightly tighten it against the nose

plate and then back the sleeve nut off 1/4 of a turn. (5) Do the same for the left hand sleeve insert nut and bell crank steering arm. (6) Now check the movement of the bell crank steering. It should move back and forth smoothly with no binding. If the steering is still binding, you can back off the sleeve nuts a little more to free up the steering. Just don't go too far or it will get sloppy. **WARNING!** This is a non-servo saver steering system. Your servo may require the use of a servo saver. This will be discussed during the steering servo installation. section. **Racer's Tip:** You can replace the four #6253 bushings with four #897 1/4 x 3/8" flanged ball bearings for reduced maintenance, but you will need a #6254 bearing spacer on top to make up the difference in height between bushings and bearings.

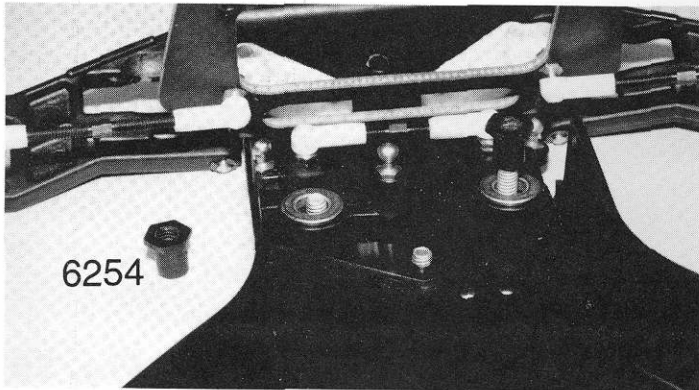


Fig. 30

□ **Figs. 31 & 32** Now go ahead and install one of the #6263 steering turnbuckles assembled in fig. 28 onto the right hand side steel ball ends on the #6221 nylon steering arms, and on the #6254 nylon bell crank arms (fig. 31). Do the left hand side. In bag #6-5 remove the #6330 body mount. Thread this onto the driver's right side screw as shown in fig. 32.

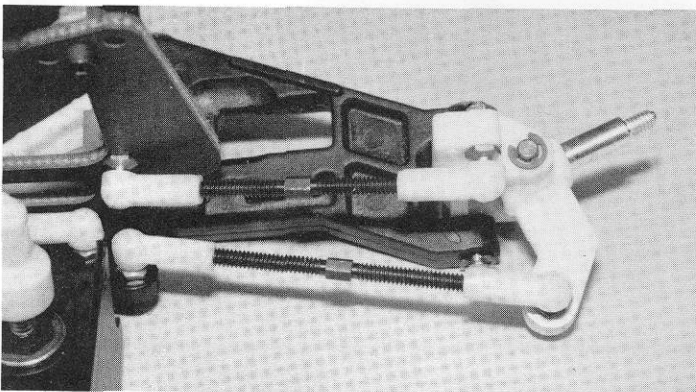


Fig. 31

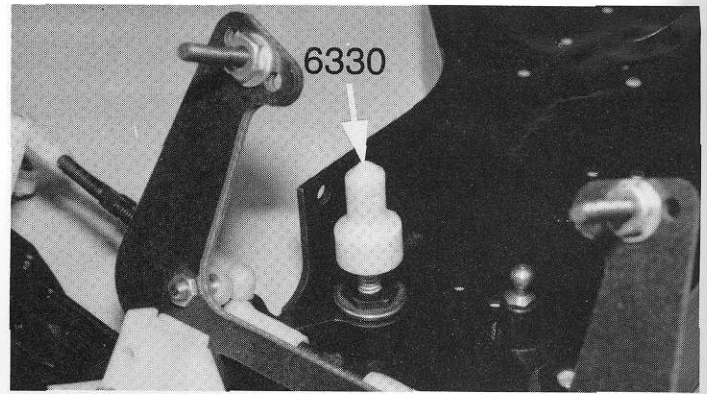
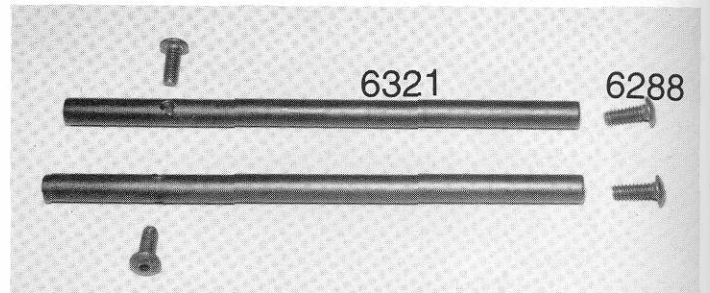


Fig. 32

□ **Figs. 33 & 34** In bag #6-4 you will find two #6321 black anodized nose brace tubes and four #6288 4-40 x 1/4" BHSScrews. One end of each nose brace tube has a tapped hole through the side, and the tube itself is tapped at the other end. There are two holes in the front of the nose plate; insert two of the #6288 BHSScrews and then thread them into the tapped end of the nose brace tube. Do not completely tighten these screws just yet. Now using the two remaining #6288 screws, mount the nose brace tubes to the chassis sides as shown in fig. 34. Once all four screws are threaded on, you can go back and tighten them.



#6288
4-40 x 1/4

Fig. 33

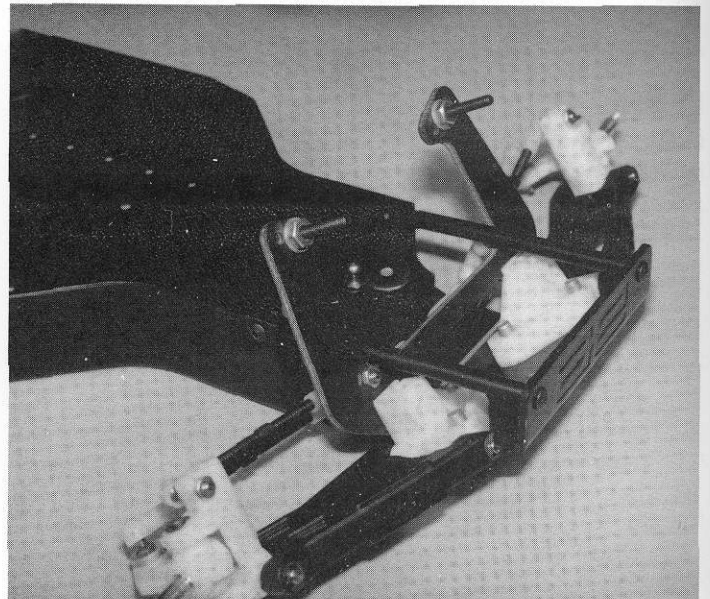


Fig. 34

STEALTH TRANSMISSION ASSEMBLY

We feel this transmission is the best in the world. Our Stealth transmission has been responsible for three of our four IFMAR 1:10 Off Road World Championship wins plus ten National Title wins in buggy and truck. 1993 proved to be one of our best years, with Brian Kinwald winning the IFMAR Off Road Worlds in Basildon, England; the 1993 ROAR 2WD Modified Nationals in Fountain Valley, CA; and the 1993 ROAR Truck Nationals in Grand Rapids, MI. Your new car has this same race-proven transmission. We know this combination will also help you greatly improve your performance, depending, of course, on how well you assemble and maintain your transmission. So take your time and assemble it to the best of your ability.

Note: The Stealth transmission uses finely engineered materials. No lubrication is required except where indicated. Using oils or similar lubricants inside the transmission can reduce its performance or cause parts failure. Excessively lubricating the ball bearings in the transmission case or diff assembly can cause the same problems.

□ **Figs. 35, 36 & 37** Open the Stealth transmission bag and locate bag A (the diff assembly). (1) From bag A remove the #6580 diff gear and the bag containing the twelve #6581 3/32" carbide diff balls. These are the larger of the two ball sizes. These carbide balls are the best available. They will outlast the diff drive rings at least ten times (if the diff is kept clean and lubed).

WARNING! NEVER replace these balls with any other balls except our #6581 carbide diff balls, for our tolerances are tighter than most other suppliers'. Due to tight tolerances and careful packaging of matched balls, when replacing lost or worn 3/32" diff balls, you MUST replace ALL 3/32" balls at the same time with new balls from the same package. This means you cannot even mix balls from two separate #6581 packages.

(2) Look at the center hole of the #6580 diff gear; if there is any flash inside the hole, then you will need to remove it. Carefully trim any excess flash from the center bearing hole with the very tip of your X-acto© knife (the tip will turn easiest when removing the flash) to make sure you do not remove any of the gear itself.

(3) From the Stealth transmission bag remove the #6591 Stealth white silicone diff lube. Another word of caution. DO NOT substitute any other type of diff lube on the balls. It took us countless hours of testing to find the correct silicone diff lube to make the diff work correctly. Do yourself a favor: use what comes in this kit!

(4) Fill the twelve ball holes in the diff gear with Stealth white silicone diff lube and then (5) push the twelve #6581 3/32" balls into the holes. (6) Wipe the excess lube back into the ball holes with your finger. Fig. 37 shows your completed gear. (7) Carefully clean all of the silicone diff lube from your hands.

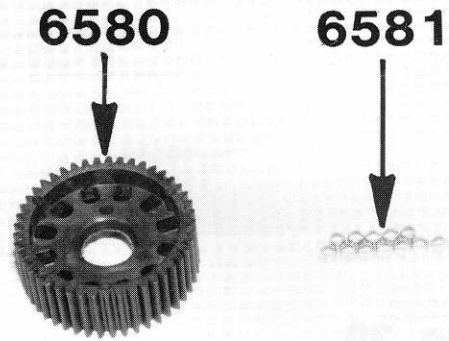


Fig. 35



Fig. 36

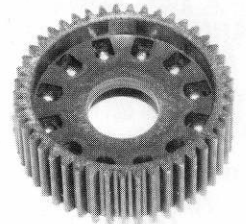


Fig. 37

□ **Figs. 38 & 39** Next open bag B which came from the Stealth transmission bag. In this bag you will find a total of eight bearings and one bushing. Take out the two smallest #6589 bearings. These have an outside diameter of 5/16" and an inside diameter of 5/32". Place one inside the center hole of the #6580 diff gear as shown in fig. 39. Set the second #6589 bearing aside, because we will be using it shortly.

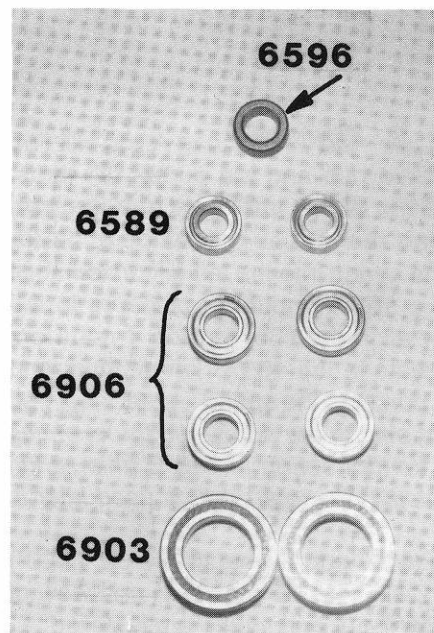
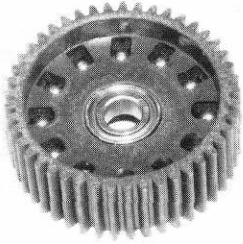


Fig. 38





#6589
 5/32 x 5/16
 unflanged bearing

Fig. 39

Fig. 40 In bag A you will find the #6575 T-nut and diff thrust bolt cover as shown in fig. 40. Remove the T-nut (which has a steel insert molded into it) from the nylon runner. **WARNING!** Make certain that you do not cut off the "ears" on the T-nut or the thrust bolt cover. Trim the diff thrust bolt cover off the same molding tree and set it aside. We will use it in fig. 77.



Do not cut the "ears" off the T-nut

(NOT ACTUAL SIZE)

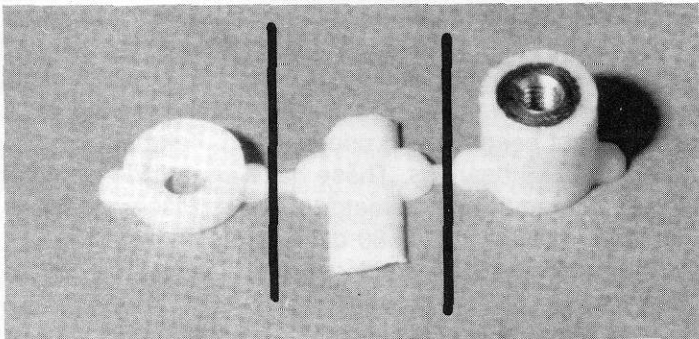


Fig. 40

Figs. 41, 42 & 43 Also in bag A you will find the #6578 left diff outdrive hub and the #6582 diff thrust spring. Make sure that the #6578 left drive hub is clean and free of all burrs and residue on the inside and outside. Carefully install the spring into the left diff drive hub; it should go in with only a slight amount of pressure to the bottom of the slot. Now align the #6575 nylon T-nut (from the last step) with the slots in the #6578 left diff hub, and push in the T-nut until it contacts the spring, steel inset end first. **WARNING!** Do not mix up the #6582 diff thrust spring with the #6587 torque control spring in bag E (this spring has a slightly larger outside diameter) that is used later in the manual.

There should now be approximately a 3/32" (.100") gap where shown in fig. 42. Fig. 43 shows an end view of the left diff drive hub after T-nut and spring are installed.

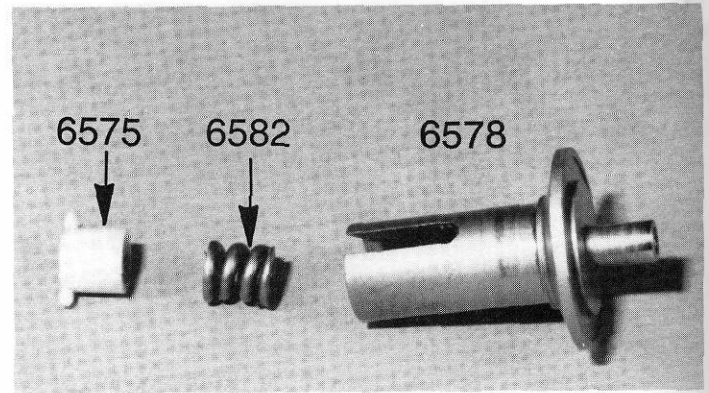


Fig. 41

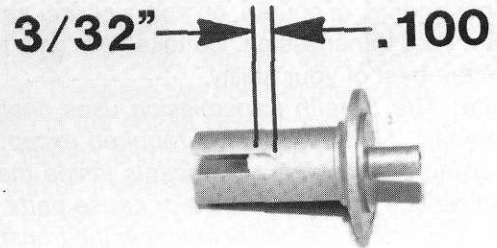


Fig. 42

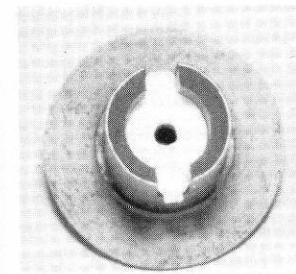


Fig. 43

Fig. 44 Take your X-acto® knife and trim off any of the plastic T-nut that extends outside of the slots in the outdrive hub as shown. This is necessary so that it will fit through the bearing when we install it in the case later on.

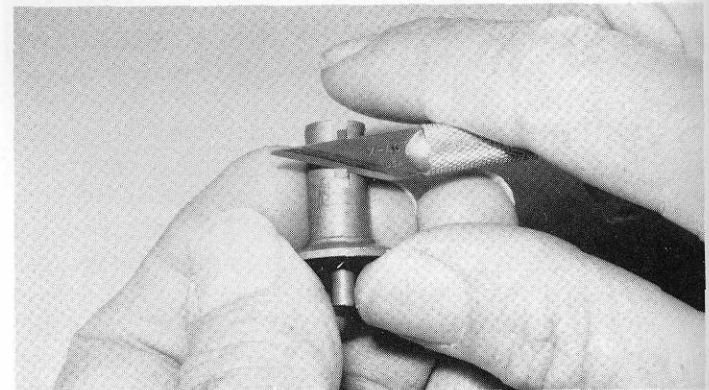
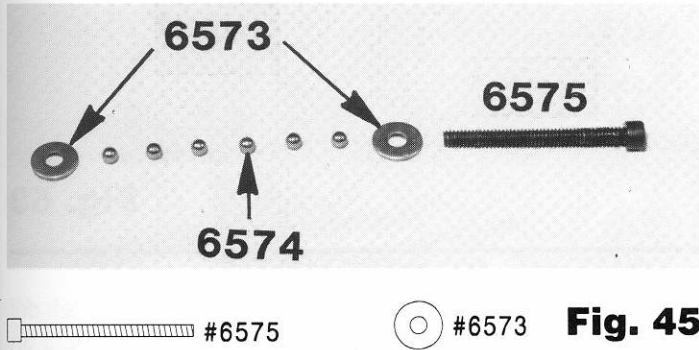


Fig. 44

❑ **Figs. 45** In bag A you will find a little bag containing the six smaller #6574 5/64" precision thrust balls. In another little bag you will find the #6575 2-56 x 1" diff thrust bolt and the two #6573 diff thrust washers. **WARNING! NEVER replace your thrust balls with any other balls except our #6574 thrust balls. Our tolerances are tighter than most other companys'. Due to these tight tolerances and careful packaging of matched balls, when replacing lost or worn 5/64" thrust balls, you MUST replace ALL 5/64" balls at the same time with new balls from the same package. This means you cannot even mix balls from two separate #6574 packages.**



❑ #6575 ○ #6573 **Fig. 45**

❑ **Figs. 46 & 47** Slip the two #6573 diff thrust washers onto the #6575 diff thrust bolt as shown. Locate your container of #6588 black grease in the Stealth bag. Now place a small amount between the two #6573 thrust washers (just enough to hold the six balls in place). **WARNING! Do not use the #6591 Stealth diff lube on these balls.**

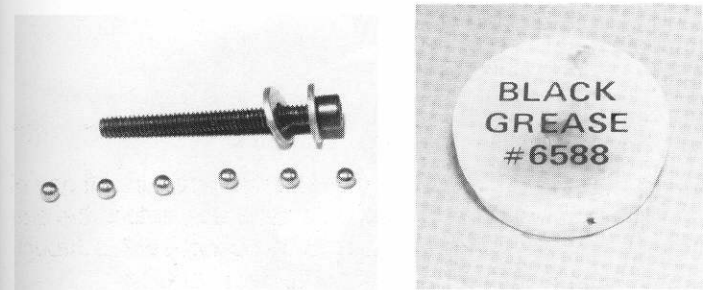


Fig. 46 **Fig. 47**

❑ **Fig. 48** Now place the six #6574 thrust balls between the two #6573 thrust washers (the black grease should hold them in place for you). **Note: Make sure you have all six balls installed between the washers, because more balls will cause the diff to loosen up and less can cause the thrust washers to crack.**

Cliff Lett's Racer's Tip: "Installing the differential thrust bearing assembly can be a pain, but try it this way: slide one of the thrust washers onto the screw and put some black grease on the washer. Put all six thrust balls in a straight line in one of the lines on the palm of your hand. Hold the

threaded end of the screw and roll the greased washer along the row of balls, picking up the balls one at a time until they are stuck to the washer in a neat circle. Install the second washer onto the screw."

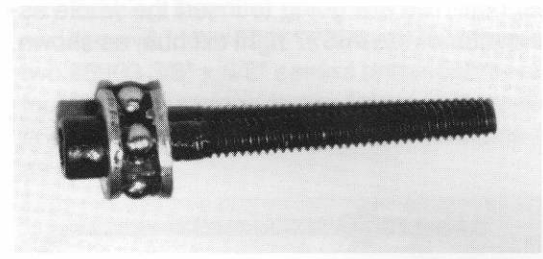


Fig. 48

❑ **Figs. 49 & 50** Now take the #6577 right diff drive hub and one #6579 diff drive ring from bag A. Also take the second #6589 5/32" x 5/16" unflanged ball bearing from bag B. **Make sure that the #6577 right diff hub is clean and free of all burrs and residue on the inside and outside.** (Fig. 49 shows both parts that will go on the #6577 right diff hub and fig. 50 shows both parts installed). The #6589 bearing will go inside the cavity in the #6577 right diff hub. They should just push in with your finger. **Never force them in!** Now place the #6579 diff drive ring onto the right diff hub. **Racer's Tip:** The Team drivers always check the diff drive rings for the side that is more rounded on the edge and place this side against the hub. This allows the diff to work better.

Your completed hub assembly should look like fig. 50. **DO NOT** try to pin the drive ring to the hub. This hub is designed to lock the drive ring without pinning. Leave AS IS.



Fig. 49

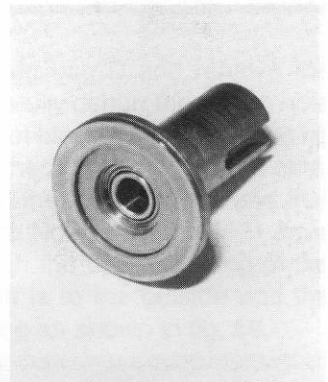


Fig. 50

○ #6589
5/32 x 5/16
unflanged bearing

□ **Fig. 51** Locate your 5/64" Allen wrench from your #6950 tool bag. Now slip the long end into the head of the #6575 diff thrust bolt. You are going to insert the whole assembly into the center of the #6577 right diff hub, as shown.

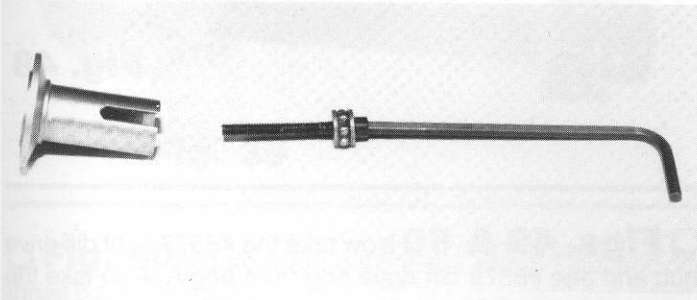


Fig. 51

□ **Fig. 52** With the Allen wrench still in the diff bolt, turn the hub assembly upright so that the wrench is on the bottom. Make sure that the #6579 diff drive ring is still on and centered. Now pick up the #6580 diff drive gear (with the balls and bearing still installed) and slip it over the #6575 diff thrust bolt onto the drive ring and hub.

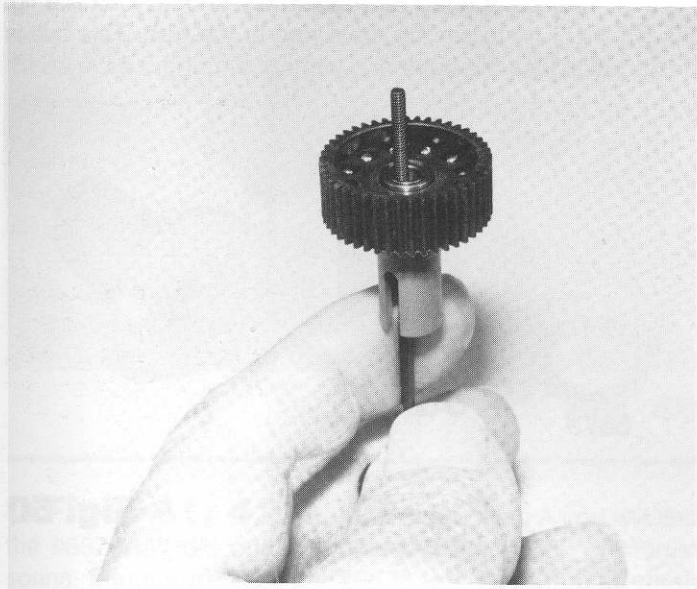


Fig. 52

□ **Fig. 53** Now take the second #6579 diff drive ring from bag A and put it on top of the diff gear over the diff balls and center it as best as you can. Remember, if you are doing the racer's setup, the rounded side will be up. **WARNING!** If you remove the gear at any time before you completely assemble the diff halves, always double check to make sure you do not have both drive rings on the same side. This can be easy to do because one of the drive rings may stick to the diff gear and the other could be stuck to the

diff outdrive hub on the same side.

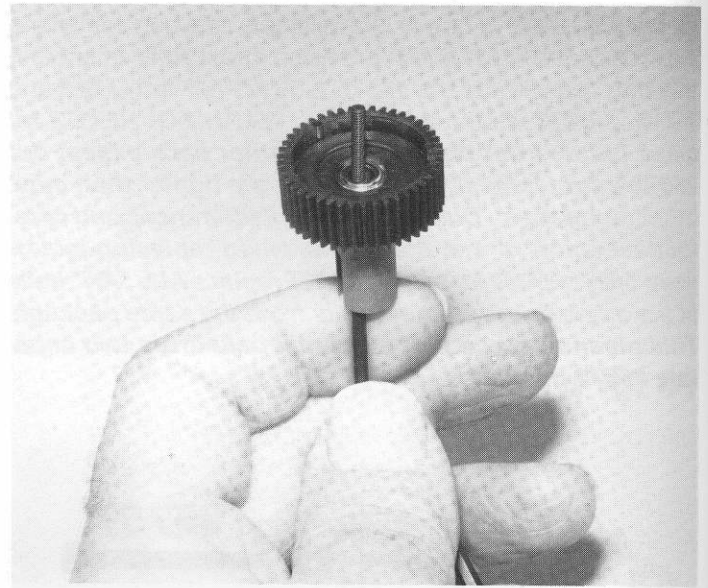


Fig. 53

□ **Fig. 54** Now we are going to install the #6578 left diff drive hub assembly over the #6575 diff bolt until it seats on the #6579 diff drive ring. IT IS VERY IMPORTANT that you make sure that the hub centers on the diff drive ring.

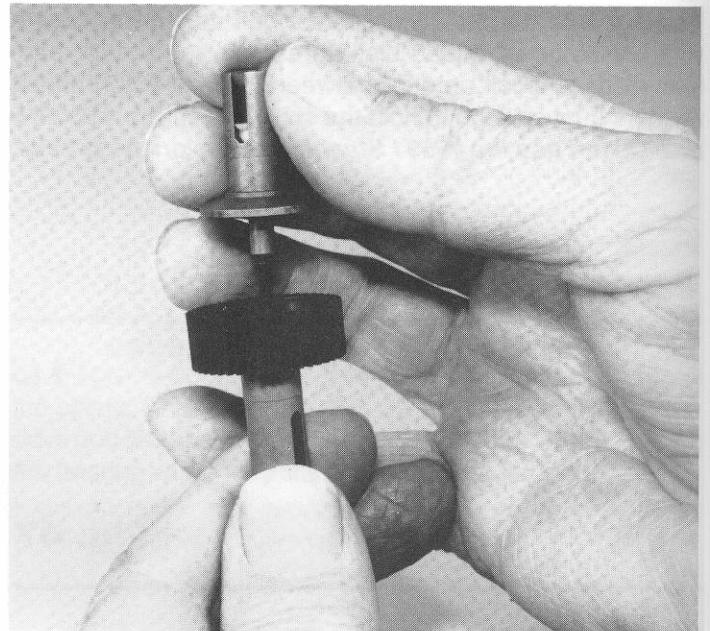


Fig. 54

□ **Figs. 55 & 56** Tighten the diff bolt using the Allen wrench, making sure that the hubs and diff drive rings stay centered. Now turn the diff assembly sideways, as shown, and tighten the diff screw until the spring collapses fully and the screw bottoms out. **DO NOT OVERTIGHTEN!** Correct adjustment is bottoming out the spring and bolt and then backing off the screw 1/8 to 1/4 of a turn.

As you are tightening the diff bolt, you will notice the ears on the T-nut (marked by the arrow) moving closer and closer to the bottom of the slot in the diff hub. The spring and diff bolt should bottom out at about the same time as the T-nut ear reaches the bottom of the slot, but if not, just make sure you bottom out the spring and bolt. Once you feel the spring and bolt bottom out, then you can back off the bolt 1/8 to 1/4 of a turn.

Your diff should operate very smoothly when turning the hubs in opposite directions. (Smoothly does not mean "free spinning". The parts will feel firmly held together but the motion will feel smooth, not rough.) After you have run the car once, recheck the diff setting. There is never a need to adjust the diff in any other way.

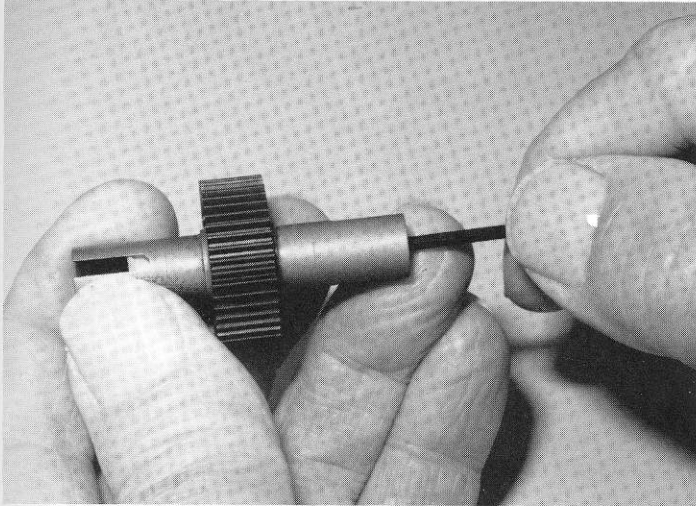


Fig. 55

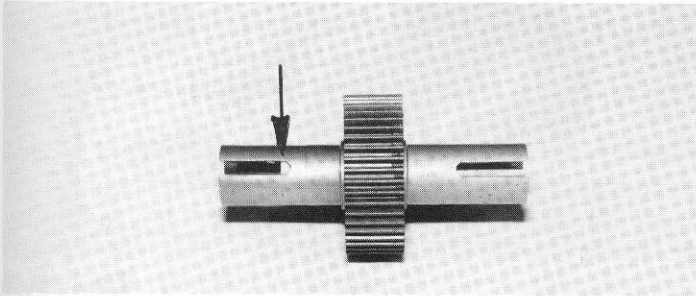
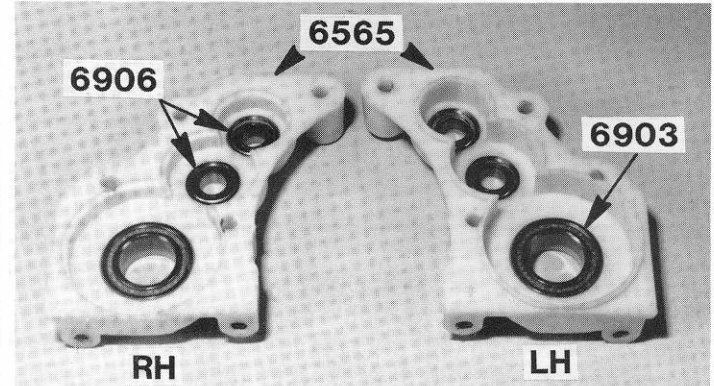


Fig. 56

□ **Fig. 57** Open bag C and remove the #6565 left and right transmission case halves. Make sure that you remove any flashing from the case halves. Now go back to bag B and remove four #6906 3/16" x 3/8" unflanged bearings and two #6903 3/8" x 5/8" sealed unflanged bearings. Install the four #6906 bearings in the four small cavities and the two #6903 bearings in the larger cavities inside the case halves as shown.




 #6906
3/8 x 3/16
unflanged bearing

Fig. 57

 #6903
3/8 x 5/8
unflanged bearing

□ **Figs. 58 & 59** Open bag D and remove the #6571 drive gear assembly. Carefully deburr the roll pin hole in the drive gear so the hole is not blocked and there are no raised edges around the hole. Check both sides of the hole. We are doing this to make sure the roll pin will fit and that the bearing will slide on the shaft. Now take the #6571 drive gear and insert the shaft through the upper bearing of the right case half so that the shaft is to the outside and the gear is inside against the bearing as shown in fig. 59.

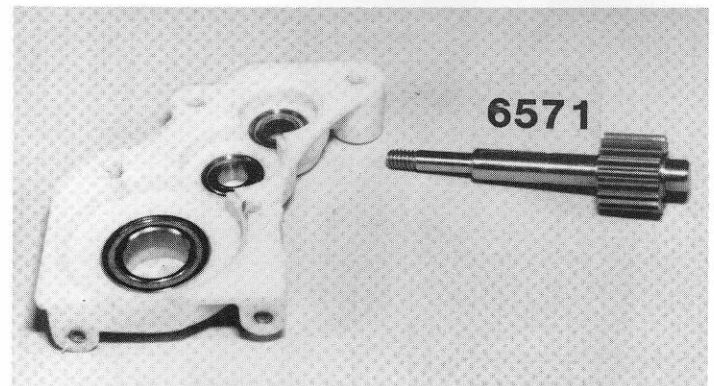


Fig. 58

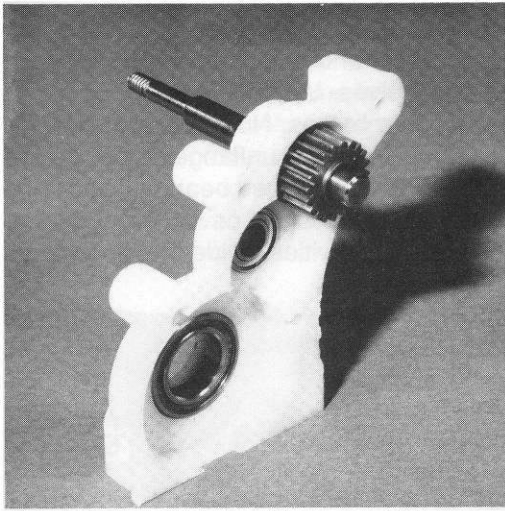


Fig. 59

□ **Figs. 60 & 61** Open bag E and remove the #6572 1/16" roll pin. Now using a pair of needle nose pliers, squeeze the roll pin into the hole in the #6571 drive shaft and center the pin. You may need to squeeze the roll pin slightly to get it started in the hole.

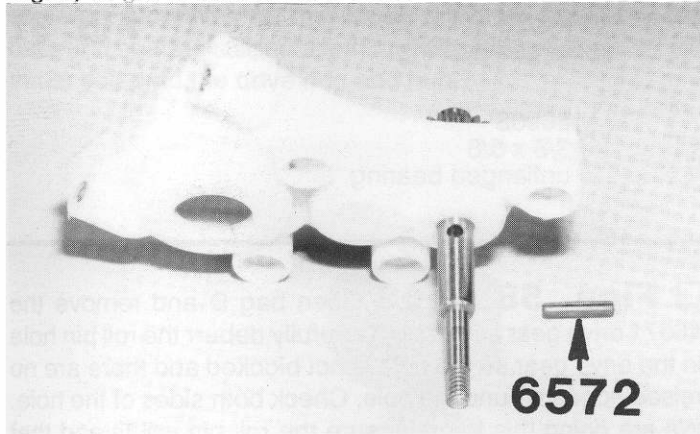


Fig. 60

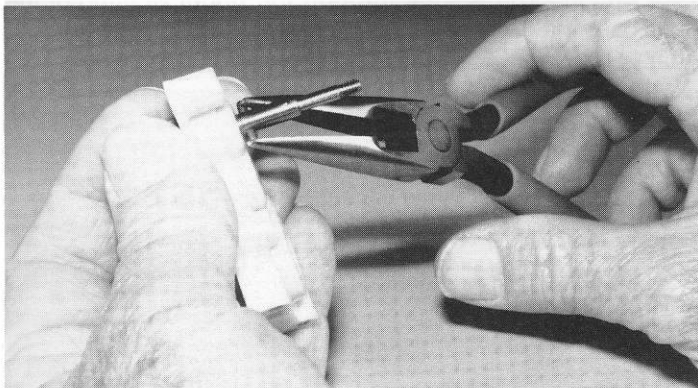


Fig. 61

□ **Figs. 62 & 63** Install the assembled diff into the right case half lower bearing as shown in fig. 60. Make sure that you install the diff bolt head side through the right case half. **Note:** If you install the bolt head so that it is on the driver's side of the transmission, you may have a problem with the diff backing off. Locate the #6570 idler gear and shaft from bag D and install it into the center bearing of the right case half. There is no right and left gear side, so it can go in either way.

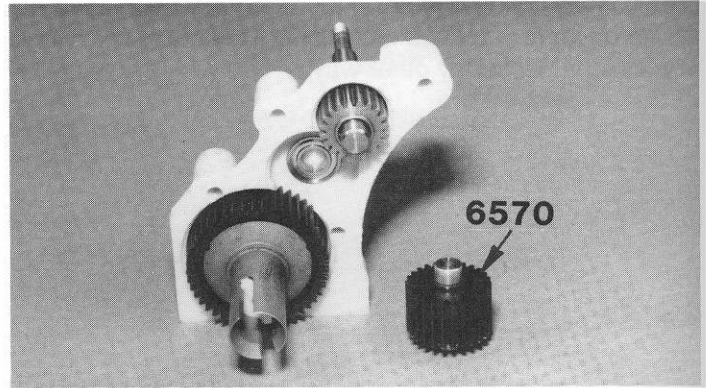


Fig. 62

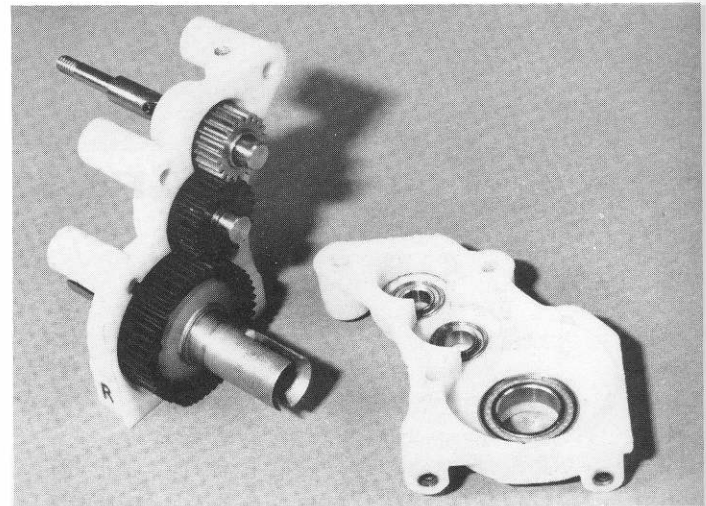


Fig. 63