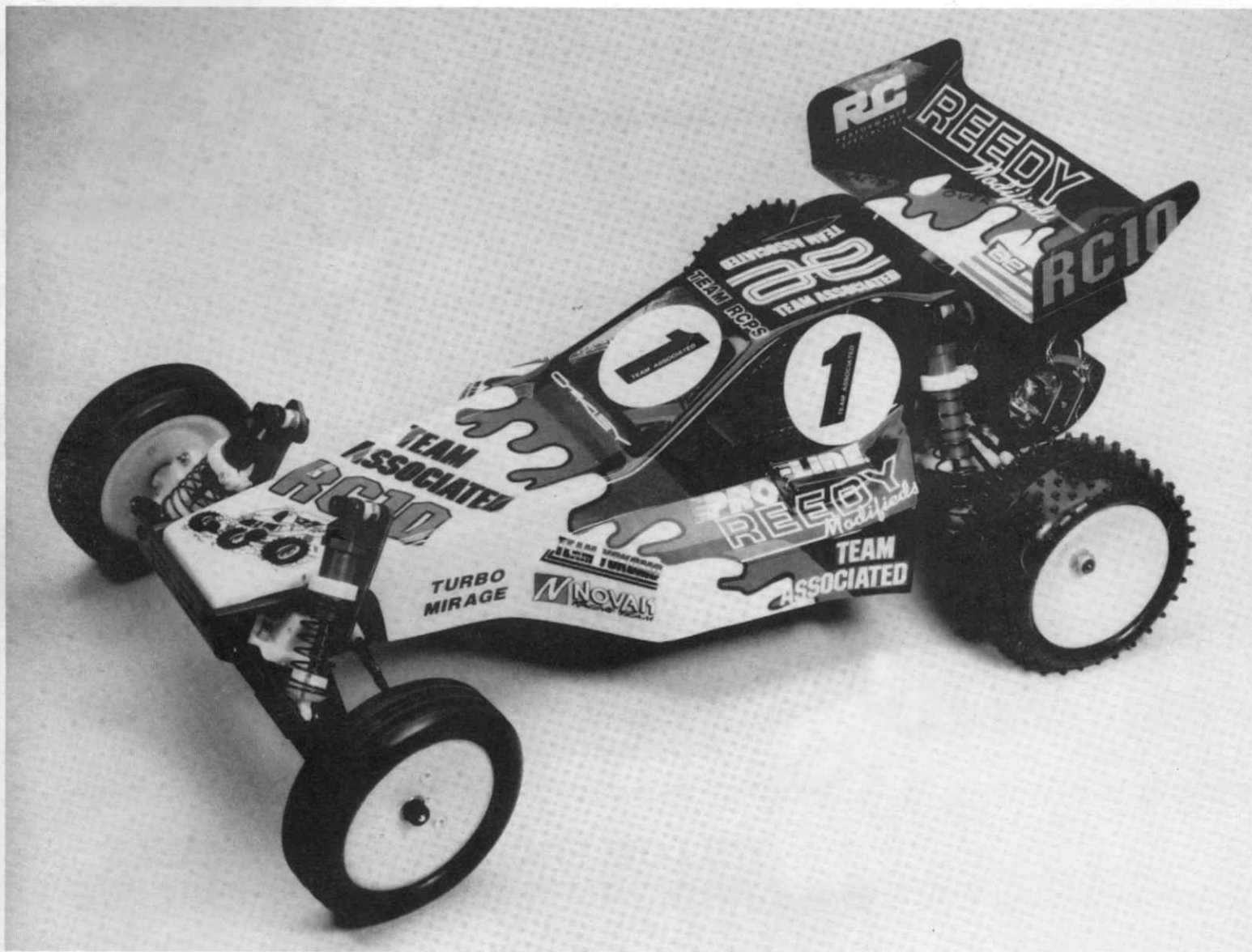


# WORLD'S CAR

## #6037 1:10 SCALE OFF ROAD KIT

---

### INSTRUCTION MANUAL



**DO NOT DISCARD THIS MANUAL!**

Save for future, hassle-free re-ordering of parts

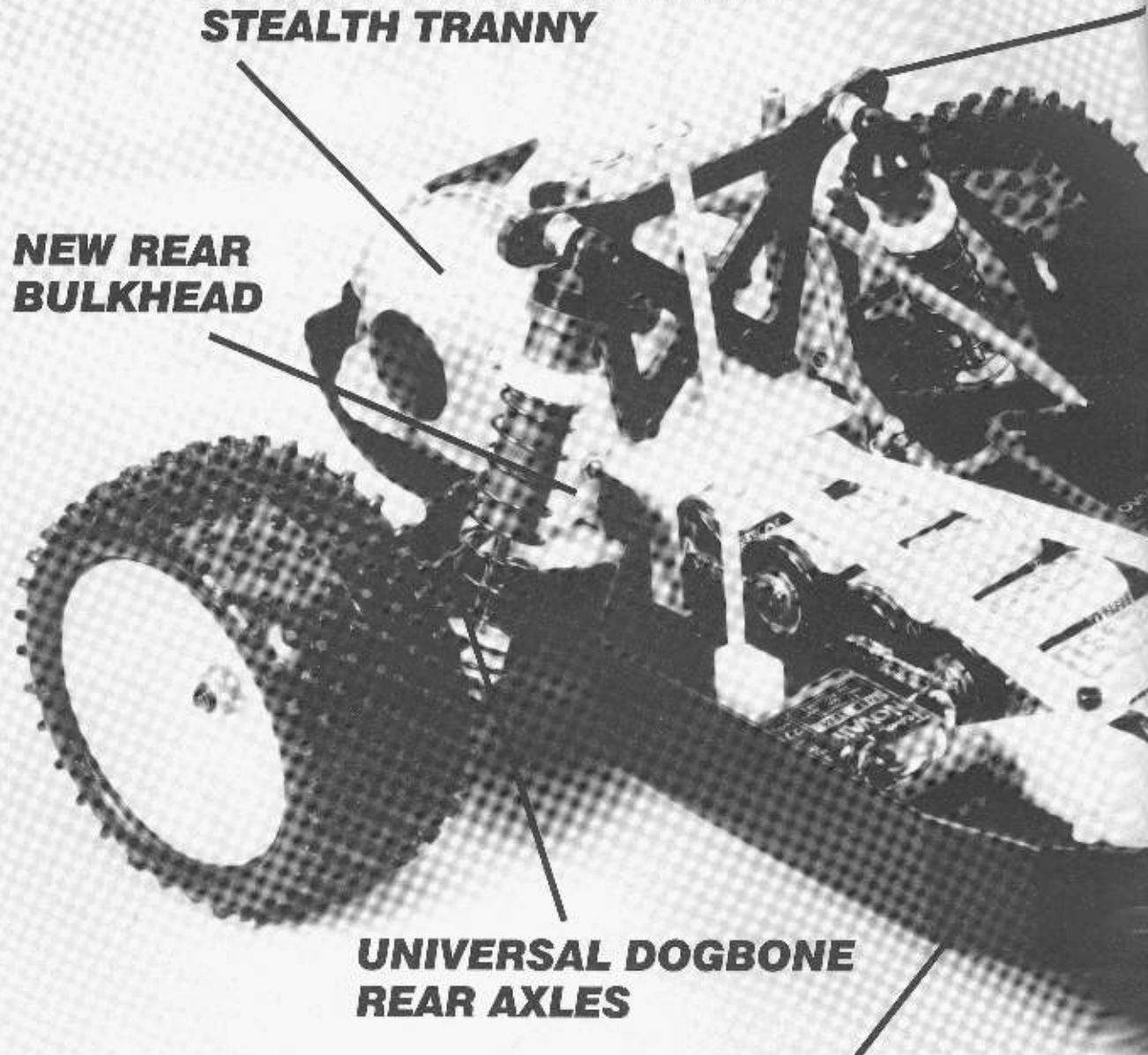
**TEAM ASSOCIATED**

Associated Electrics, Inc.  
3585 Cadillac Ave.  
Costa Mesa, CA 92626



**CHAMPIONSHIP-WINNING  
STEALTH TRANNY**

**NEW REAR  
BULKHEAD**



**UNIVERSAL DOGBONE  
REAR AXLES**

**STRONGER, PRE-MILLED,  
HARD ANODIZED  
ALUMINUM CHASSIS**

**NEW YELLOW FRONT & REAR WHEELS  
WITH PROLINE TIRES & FOAM INSERTS**

**NEW GRAPHITE FRONT & REAR  
SHOCK STRUTS**

**NEW FIBERGLASS BATTERY STRAP**

**NEW BUSHING  
BELLCRANK STEERING**

**HARD ANODIZED,  
TEFLON SEALED SHOCKS**



**SILICONE SHOCK OIL**

**NEW STRONGER  
SUSPENSION ARMS**

**RC10 WORLD'S CAR**

**CHAMPIONSHIP FEATURES**



# FIRST, A WORD ABOUT YOUR NEW CAR

Your new RC10 World's Car includes all of the newly designed parts our Team has been using that have helped us win four of the five 1:10 Off Road World Championships ever held. We feel there is no better car available.

As great as the existing Team Car has been, we know we have to continually work at improving our car so we can stay ahead of our competition. This car will show you that we have been busy working on a number of important upgrades. While the new car looks similar to the old car, there are many new changes. The new car starts with a black, hard anodized aluminum chassis made from a new material which is stronger than our original chassis, and it comes with the bottom of the chassis already milled out like our Team uses. It also comes with:

- Graphite front and rear shock struts
- New, stronger, suspension arms
- New rear bulkhead with new adjustment points
- Fiberglass battery strap
- Graphite transmission brace
- New yellow wheels (3 piece fronts with aluminum screws and one piece 2.175" rears) which come with Proline XTR compound tires with foam inserts
- RC Performance Specialities Turbo Mirage Lexan body
- New bushing bellcrank steering
- Silicone shock oil
- 1.02 rear shock shafts and suspension travel limiters for front and rear shocks.
- The car also comes with our Championship-winning Stealth transmission
- Hard anodized Teflon sealed shocks
- Teflon shock pistons
- Aluminum inline front axles
- 30° caster blocks
- Universal dogbone rear axles
- *And more!*

## BEFORE YOU BEGIN

You will find the photos so easy to follow that you may be tempted to put the car together from the photos alone. However, although you have the best car kit, if you want the best COMPLETED model race car, then you will want to put it together correctly by following these instructions. All that's required is to read the few lines of text near each photo.

**Take your time assembling the car.** It's not a race to see how fast you put it together; it's how well you put it together that determines how fast you can race. Please note the steps below before you begin to assemble your kit.

**Step 1 OPEN THE PARTS BAGS WHEN THE STEP SPECIFIES, NOT BEFORE,** otherwise you will get the parts mixed up and then you will have trouble assembling your car. **When you open each main bag for the first time, check the contents against the parts list** supplied as a separate sheet that came with your manual.

All major parts bags are referred to by number in the manual. While building the car, you will sometimes be working with several bags at the same time. Inside each major parts bags there are more bags; these are not numbered and belong to the bag they came out of.

**Step 2 KEEP THE PARTS SEPARATE.** While building the car you will sometimes be working with several parts bags at the same time. Bags and parts will start multiplying like rabbits as you build. Try not to confuse parts from one bag with another. A good way to prevent this is to use large paper plates (picnic plates with partitions are the best). They will help you separate the parts and they give you enough area to spread them out in so they will be easier to find. Mark the plates with the bag numbers before you put the parts into them. When the plates are used up you can relabel the plate for another bag.

We have included some miscellaneous spare fasteners and clips, so do not worry when you have parts remaining after you have finished.

**Step 3 CHECK THE SUPPLEMENTARY SHEETS.** Associated is constantly testing new and improved components and then updating the kit with them when they test out to be beneficial. Not all updates will be noted in the written manual (the manuals cannot be reprinted to keep up with the updates). So before you begin, check each parts bag to see if they contain any supplementary instruction sheets. If so, locate the section of the manual where this change first applies and attach the sheet(s) to that section so you will not forget about the changes when assembling the kit.

**Step 4 ADDITIONAL ITEMS NEEDED TO OPERATE THE CAR:**

- 2 channel R/C surface radio system.
- Battery pack (6 or 7 cell).
- Battery charger (for 6 and/or 7 cell packs).
- Electronic Speed Control.
- R/C electric motor.
- Servo saver (Assoc. #8435 or #5551, or Kimbrough equivalent). Using this item is optional depending upon steering servo used and your setup preference.
- Motor pinion gear (48 pitch); size will be determined by type and wind of motor being used.

**Step 5 TOOLS.** Your kit contains the four Allen wrenches and the turnbuckle/shock wrench that you will need to assemble your car kit, but you will still need the following tools:

- #2 Phillips screwdriver (Assoc. #SP-76)
- Needle nose pliers
- Hobby knife, such as a X-acto© with a pointed blade
- Soldering iron (40 to 50 watts) and a small amount of ROSIN (not acid) core 60/40 solder.
- Super glue (instant adhesive)
- Ruler with decimal inches or metric measure

The kit can be assembled faster and easier with the following tools:

Screwdriver handle Allen wrenches from Associated in sizes:

- #6957, .050"      ● #6958, 1/16"      ● #6961, 2.5mm
- #6959, 5/64"      ● #6960, 3/32"
- A 3/16" nut driver will make installing the ball ends and upper arm turnbuckles easier. (#SP-86)
- A 1/4" nut driver will make installing the 4-40 nuts easier. (#SP-85)
- An 11/32" nut driver will make installing and adjusting the 8-32 rear axle diff nut easier. (#SP-82)
- A precision ruler with decimal inches or metric measure.

**WARNING!** Do not use a power screwdriver to install screws into nylon parts. The rotation speed is too fast, and causes the screws to heat up when being driven into plastic or nylon parts, then strips them out.

## ☐ Step 6 FINAL NOTES:

(1) For you experienced builders and racers: **please build the car our way first!!** The RC10 Worlds Car is a remarkably fast buggy right out of the box. There's a good reason for everything on the car, and very few compromises were made in its design. If you build it our way first you can see what your car is capable of before you make changes and you will then have a base point to compare against.

(2) Put a check mark in the box ( ☐ ) at each step after you finish it. Then when you stop during assembly, it will be easier to find where you need to continue from.

(3) To help you identify certain parts, occasionally an actual-size drawing will accompany the photo. (See example in fig. 2.) You can place your part on top of the drawing to be sure you have picked up the right part. Most likely you will end up with spare parts and fasteners, but this is nothing to worry, about because we have deliberately left you with some spare items.

(4) We have used some special abbreviations throughout this manual for the various types of screws used. The following list identifies what the abbreviations stand for:

- FHMScrew: Flat Head Machine Screw. Standard thread screw which requires a Phillips screwdriver.
- FHSScrew: Flat Head Socket Screw. Standard thread screw which requires a Allen wrench or driver. The same type of tool is used for the two following fasteners:
- BHSScrew: Button Head Socket Screw.
- SHCScrew: Socket Head Cap Screw.

(5) In order to keep a sense of direction when building the car, we use the following descriptions to standardize the right and left sides of the vehicle. The driver's side or left side: with the driver sitting in the driver's seat facing the front of the car, his left hand is the driver's side. The passenger or right side will be the driver's right hand side.

(6) The following types of special instructions, *in italics*, will be used throughout the manual:

● **Racer's Tip:** This is a trick used by some of the Team drivers to improve their car's handling or performance, or simplify its maintenance.

● **Note:** Alternate ways to assemble the kit, including tips for smoothing out difficult assemblies.

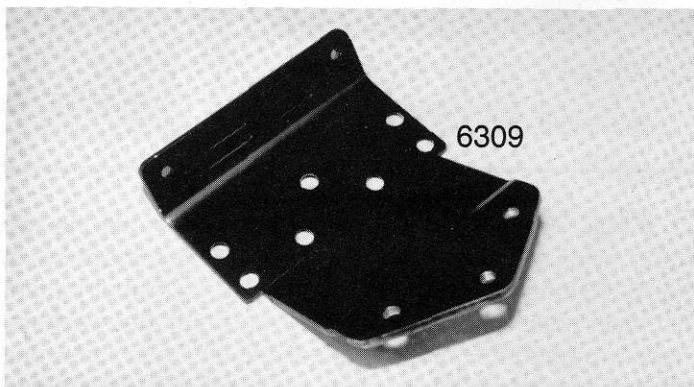
● **WARNING!** This alerts you to be careful to prevent damage to parts or use of wrong parts that may reduce performance.

**SAVE THIS MANUAL! This is more than an in-**

**struction manual. It is also a handy supplement to the Team Associated 1:10 scale off road buggy catalog. You can use the manual photos and descriptions to identify part numbers and names to help you order parts. Use the current catalog for pricing.**

## FRONT END ASSEMBLY

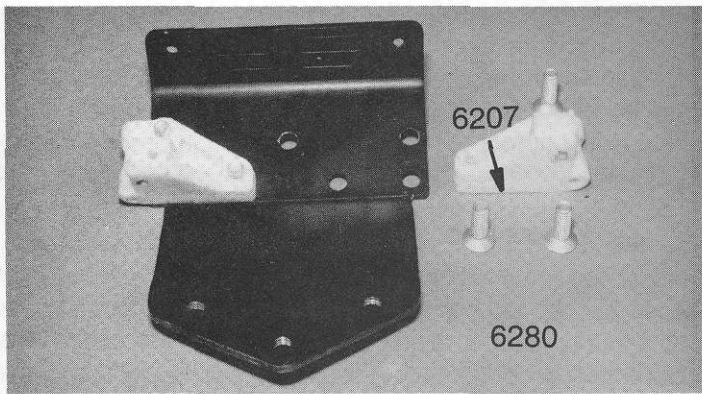
☐ **Fig. 1** Read pages four and five entirely before proceeding! We'll start by removing the #6309 black anodized aluminum nose plate from bag #6-4. It will look like fig. 1.



**Fig. 1**

☐ **Fig. 2** In bag #6-1 you will find the #6207 front suspension mounts (they are connected by a molding runner) and six #6280 8-32 x 1/2" aluminum FHMScrews. Fig. 2 shows the left side front suspension mount installed. It also shows the right mount and the three #6280 screws used to mount it to the nose plate.

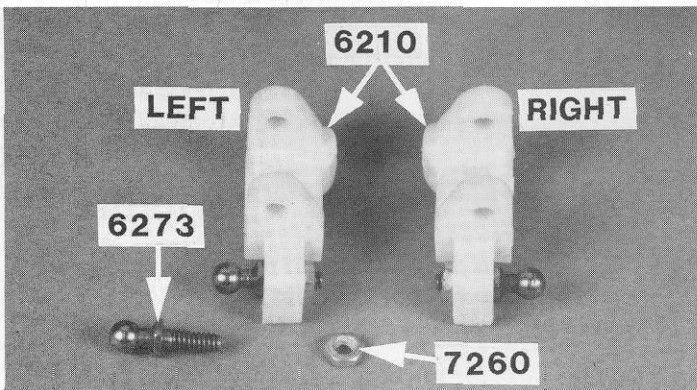





 #6280  
8-32 x 1/2  
aluminum

**Fig. 2**

□ **Fig. 3** From bag #6-14 remove two #6273 long ball ends and two #7260 4-40 small thin plain nuts. Now open bag #6-1 and remove the #6210 front carrier blocks. The carrier blocks are connected by a small molded runner which you must remove with your X-acto<sup>®</sup> knife. Be sure to remove ALL of the runner. Screw one of the #6273 ball ends into each carrier block as shown and then thread on the #7260 thin plain nuts. **NOTE:** A 3/16" nut driver will make installing the steel ball ends and small 4-40 nuts easier.

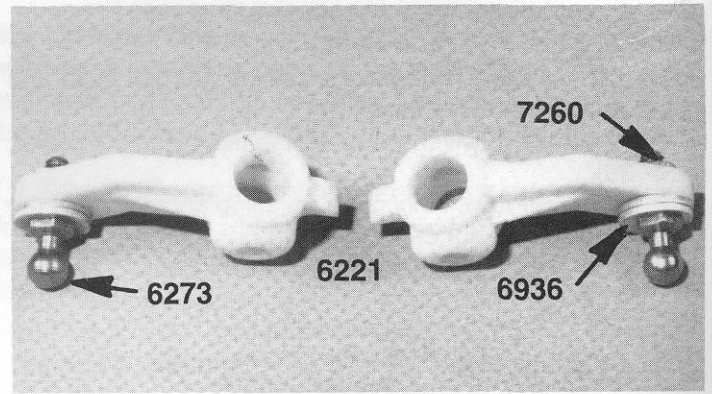


 #7260  
4-40  
thin plain nut

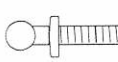
 #6273  
4-40

**Fig. 3**


□ **Fig. 4** Go to bag #6-1 again and remove the two #6221 nylon steering blocks. From bag #6-14 remove two of the #6273 long steel ball ends, two #7260 4-40 small pattern thin plain nuts, and four #6936 #4 aluminum flat washers. Place two washers onto each steel end and then screw one ball end into each steering block as shown, and then thread on the #7260 4-40 thin plain nut from the back side. Make sure the balls are mounted on opposite sides of the steering blocks so that they both will be on top of the steering blocks when mounted on the car.



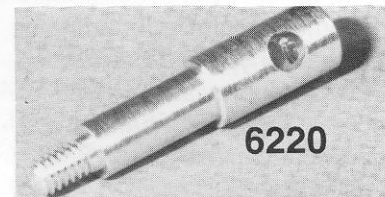
 #6936  
#4 flat washer  
aluminum

 #6273  
4-40

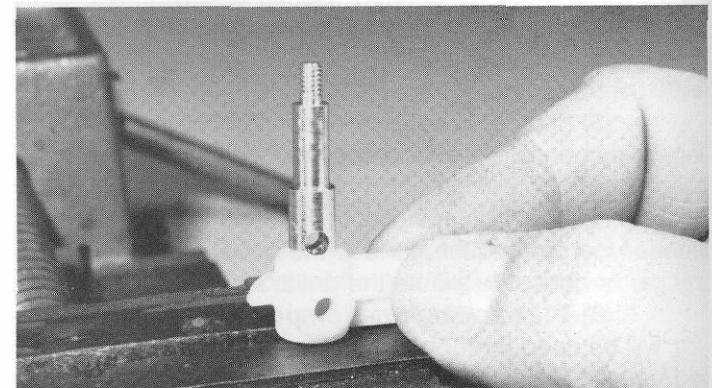
**Fig. 4**

 #7260  
4-40  
thin plain nut

□ **Figs. 5 & 6** Remove the two #6220 aluminum inline front axles from bag #6-1 (fig. 6). Install one axle in each #6221 nylon steering blocks (fig. 7), making sure that the hole in each axle lines up with the hole in the steering block. The parts should push together with your fingers; if they don't, fit a 1/4" nut driver over the threaded end of the axle and then push the axle into the steering block. **WARNING!** Threads on the end of the axle are aluminum and can be easily damaged by the nut driver. Repeat the process for the second axle and steering block.



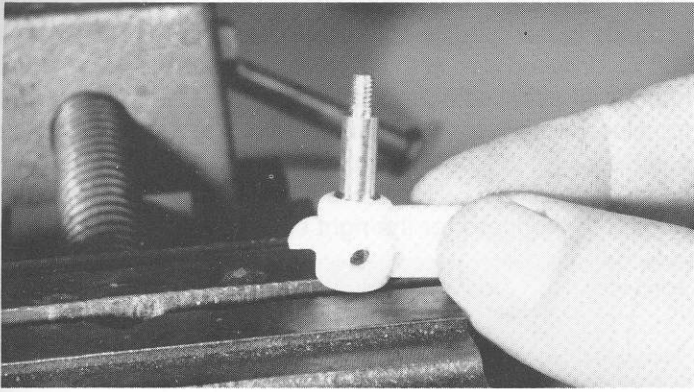
**Fig. 5**



**Fig. 6**

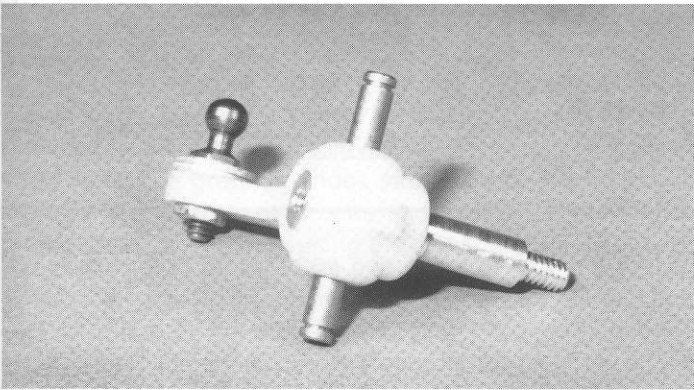
□ **Fig. 7** The axle is round and will be fairly tight in the steering block, so try to align the hole in the #6220 axle with the hole in the #6221 nylon steering block as you are assembling the parts. **WARNING!** Do not use pliers on the bearing surface of the axle, because this can damage the

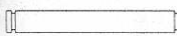
axle surface so that the bearings will no longer fit. The larger diameter of the axle will still be sticking out of the steering block slightly; that's okay. Just make sure the holes line up.



**Fig. 7**

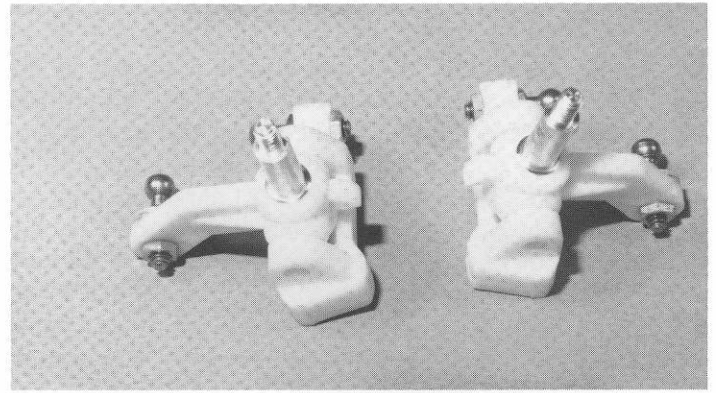
□ **Fig. 8** In bag #6-1 you will find two #6223 kingpins. This bag contains several different length pins, so match the pins to the actual-size drawing below. Check that each kingpin will go through both steering blocks and axles. If you don't do this, it will be almost impossible to get the kingpin to go through the #6210 carrier block and the steering block and axle when we assemble them. Once you have checked the fit of the kingpins, remove them again.


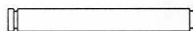


 #6223

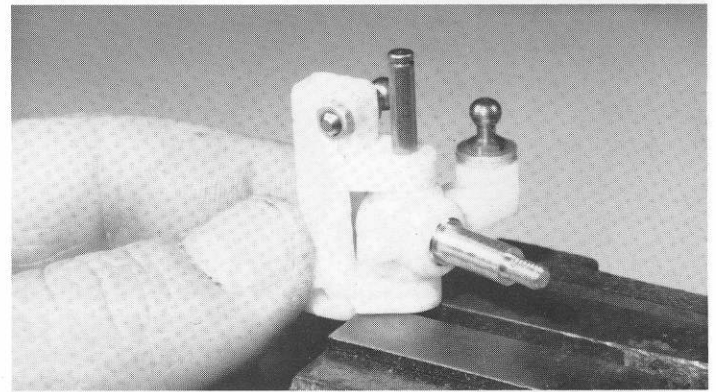
**Fig. 8**

□ **Figs. 9, 10, 11 & 12** Take the two #6210 carrier blocks and install the steering blocks and axles into each one. Both ball ends will be on the same side when installed correctly, and the raised side of the angle on the bottom of the #6210 carrier block will be away from the ball side. Now reinstall one of the #6223 kingpins through each of the carrier block/axle assemblies as shown in figs. 10 and 11. Try to center the kingpins. Fig. 12 shows a package of #6299 1/8" E-clips from bag #6-1. Remove two from the package and install one on each of the kingpin's two grooves. Now take out two more E-clips and install them on the other kingpin.

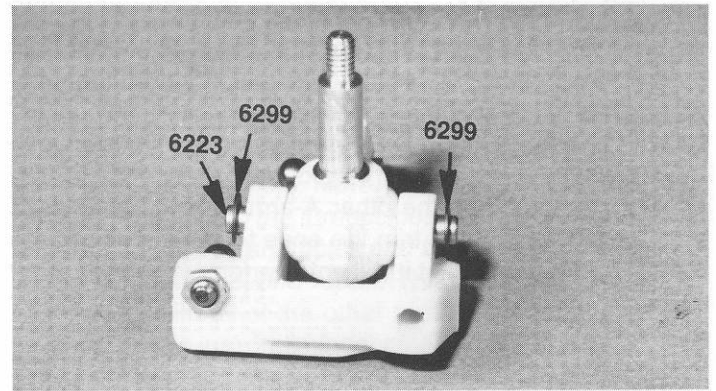


 #6299  
e-clip  
1/8 shaft  #6223

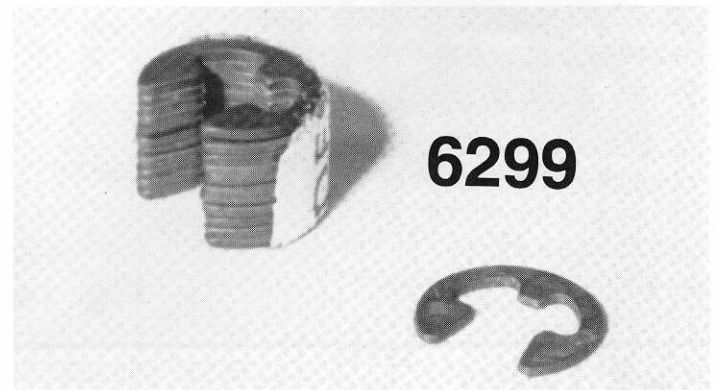
**Fig. 9**



**Fig. 10**



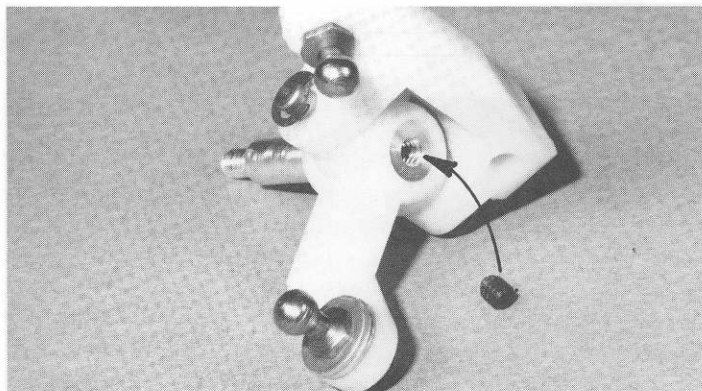
**Fig. 11**



**Fig. 12**



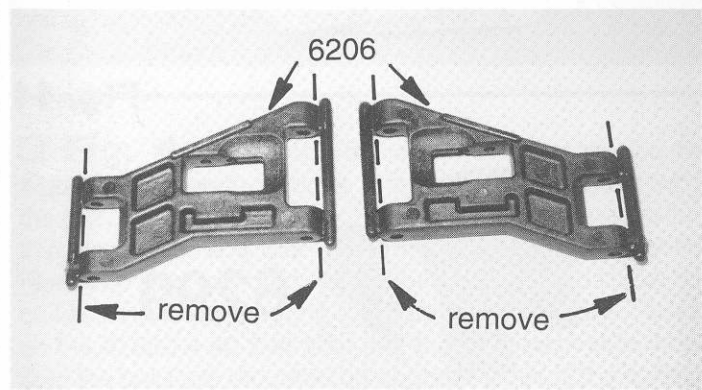
□ **Fig. 13** In bag #6-1 you will find two small #6951 4-40 x 1/8" set screws. Locate your #6950 tool bag (which contains four sizes of Allen wrenches) in the large master parts bag. Take out the smallest Allen wrench (.050") and install the two set screws into the #6221 aluminum front axles. Rotate the steering blocks in the block carriers so that you can see the threaded hole on the back side of the front axle. Using the same Allen wrench, install the set screw into the back of the front axle until it tightens down on the kingpin as shown in fig. 14. Do the same with the other axle assembly.



□ #6951 set screw

**Fig. 13**

□ **Fig. 14** Now remove the two #6206 new black front suspension arms from bag #6-1. They are made of stronger material. Removing the parts molding runner is harder than before. The best way to remove the runners from the arms will be to firmly grab the runner with a pair of slip joint pliers where the arm attaches to the runner, and push down with the pliers. When the runner breaks free, do the other three attaching points, then the other A-arm. Now carefully take your X-acto© knife and trim the ends to remove any of the remaining runner so that it will not interfere with suspension travel.

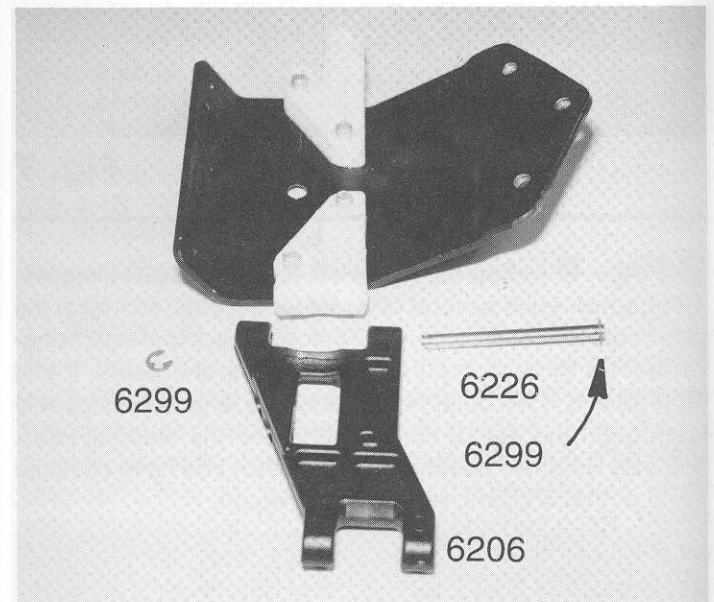


**Fig. 14**

□ **Fig. 15** Now remove the two #6226 front inner hinge pins and four #6299 1/8" E-clips from bag #6-1. Slip one of the hinge pins into each end of the front suspension arm to

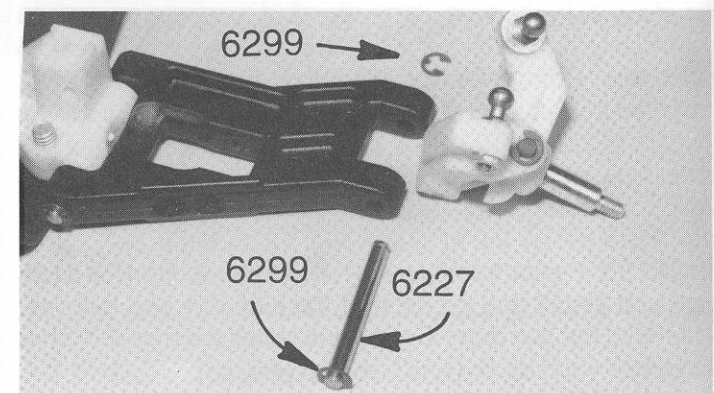
check the pin fit. The A-arm should be able to swing freely on the pin. *Racer's tip: Most racers keep a .126" straight reamer in their tool box to free up the suspension arm pin holes and to clean them after racing. We DO want the pin to fit tightly in the #6207 front suspension mounts.*

Line up one of the #6206 front A-arms with the left hand front suspension mount. Now push one of the #6226 front inner hinge pins through the front of the arm, the mount and then the back of the arm as shown. Use a small screwdriver to push an E-clip into each groove of the hinge pin. Repeat the process for the right side suspension arm.



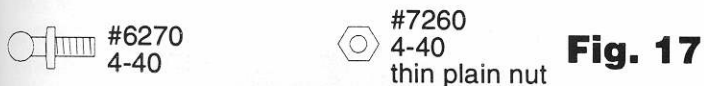
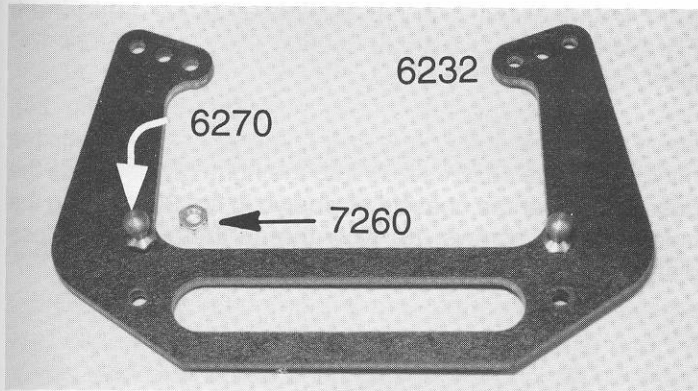
□ #6299 e-clip 1/8 shaft □ #6226 **Fig. 15**

□ **Fig. 16** Remove two #6227 front outer hinge pins and four #6299 1/8" E-clips from bag #6-1. Now take the left hand steering block and carrier assembly from fig. 10. Line up the left hand carrier/steering block assembly between the outer holes on the left hand front suspension arm. Install the hinge pin through the arm and carrier block. Now install an E-clip into each groove of the pin. Do the same for the right hand parts.



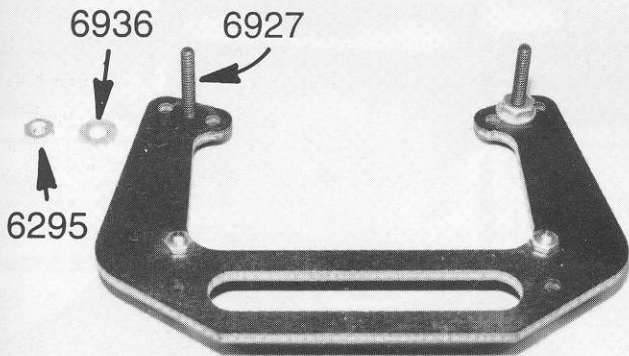
□ #6299 e-clip 1/8 shaft □ #6227 **Fig. 16**

□ **Fig. 17** In bag #6-1 you will find the #6232 new graphite front shock strut. From bag #6-14 remove two #6270 short steel ball ends and two #7260 small 4-40 plain nuts. Thread the ball ends into the graphite shock strut (see fig. 18) and then thread the plain nuts onto the ball ends.

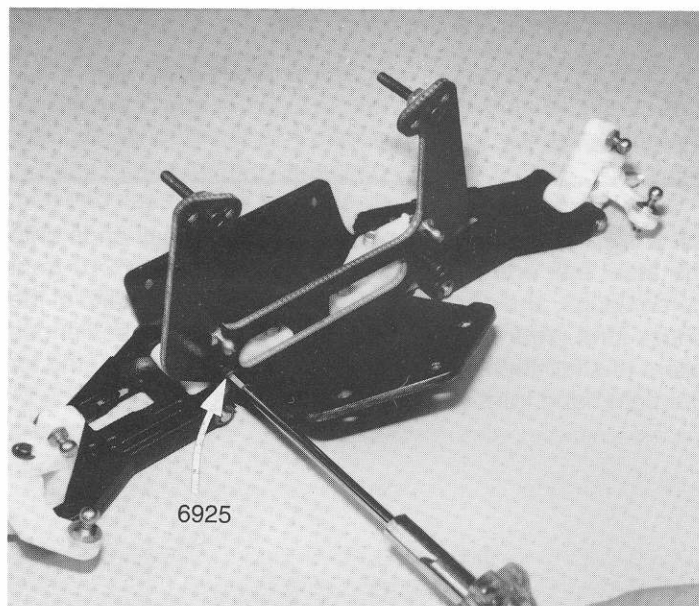
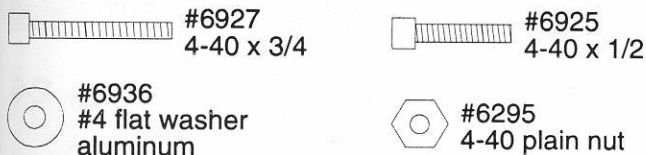


**Fig. 17**

□ **Figs. 18 & 19** From bag #6-10 remove two #6927 4-40 x 3/4" SHCScrews, two #6936 #4 aluminum washers, and two #6295 4-40 plain nuts. Then from bag #6-1 remove two #6925 4-40 x 1/2" SHCScrews. Thread the two #6927 4-40 x 3/4" SHCScrews into the middle of the three holes on the top of the shock strut. The heads of these screws will be on the same side as the #6270 steel ball ends. Slip the washer then the nut on the screw. Now do the second screw. Now line up the graphite shock strut with the back side of the front suspension mounts as shown. Fasten the shock strut to the #6207 mounts using the two #6925 SHCScrews.



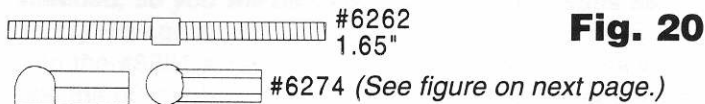
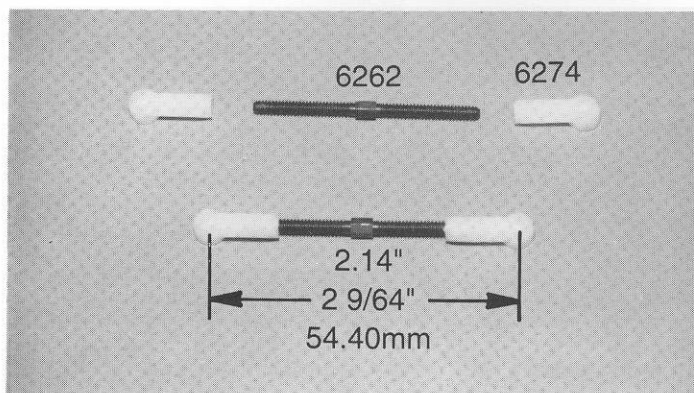
**Fig. 18**



**Fig. 19**

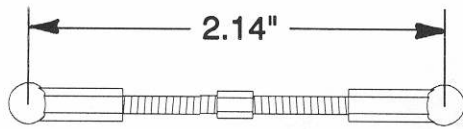
□ **Fig. 20** In bag #6-1 you will find two #6262 1.65" long turnbuckles and in bag #6-14 the #6274 plastic ball end cap molded tree. Remove four of the plastic ball end caps and thread them onto the two turnbuckles. The plastic ball end caps on both ends will face the same direction. **Note:** Each turnbuckle rod has right hand threads on one end and left hand threads on the other, so the plastic end caps will thread on in opposite directions on each end.

Make sure you thread on the #6274 plastic ball ends evenly so that you will have maximum adjustment range. Adjust your plastic ball ends until they are 2.14" (2 9/64" or 54.40mm) from the center of the ball end hole to the center of the other ball end hole. **Note:** If you overtighten the plastic ball end caps onto the turnbuckles, you will push the turnbuckles into the ball end holes and the plastic ball end caps will be damaged beyond repair. This turnbuckle measurement, along with all of the other turnbuckle measurements still to come, are just preliminary measurements. We will fine tune the adjustments at the end of the instruction manual.



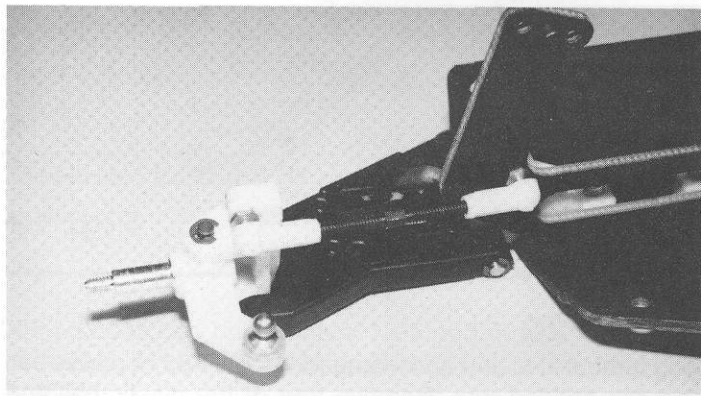
**Fig. 20**





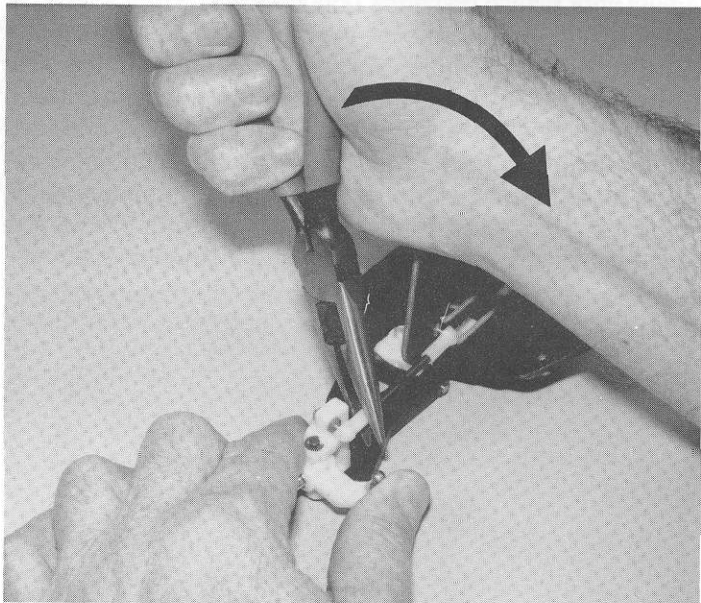
(dimension for fig. 20)

□ **Fig. 21** Snap the plastic turnbuckle ball ends onto the steel ball end on the top of the left hand #6210 front carrier block, and on the steel ball end on the left hand of the shock strut. You will probably have to use your needlenose pliers to snap them on. Now go ahead and do the same for the right hand turnbuckle assembly.



**Fig. 21**

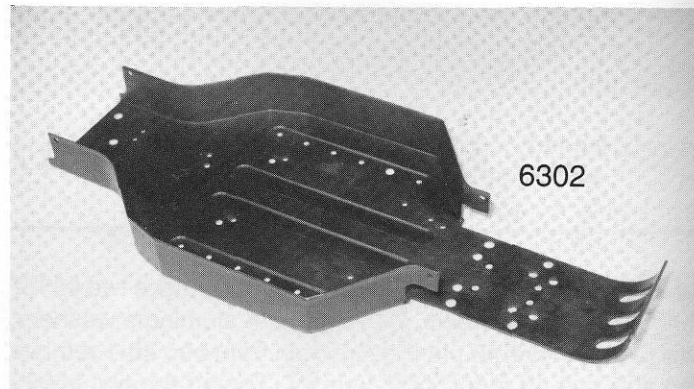
□ **Fig. 22** The turnbuckle tie rods can be easily removed by carefully holding the plastic ball end with your needlenose pliers (next to the ball) and twisting the plastic rod end off of the steel ball.



**Fig. 22**

□ **Figs. 23, 24 & 25** Now we'll attach the #6309 nose plate assembly to the new #6302 black hard anodized aluminum chassis. You will see that your chassis (fig. 23) has already been milled the same as used by our Team drivers. In bag #6-2 you will find one #6280 8-32 x 1/2" aluminum FHMScrew, one #6281 8-32 x 7/8" aluminum FHMScrew. In bag #6-4 you will find one #6931 8-32 x 1/4" steel FHMScrew

(1) Looking from the back of the chassis (fig. 24), insert the #6280 screw into the left, the #6931 screw into the middle, and the #6281 screw into the right. (2) Now slide the nose plate over the chassis as shown in fig. 24, aligning the holes with the screws. (3) Now thread them into the nose plate until they are as in fig. 25.

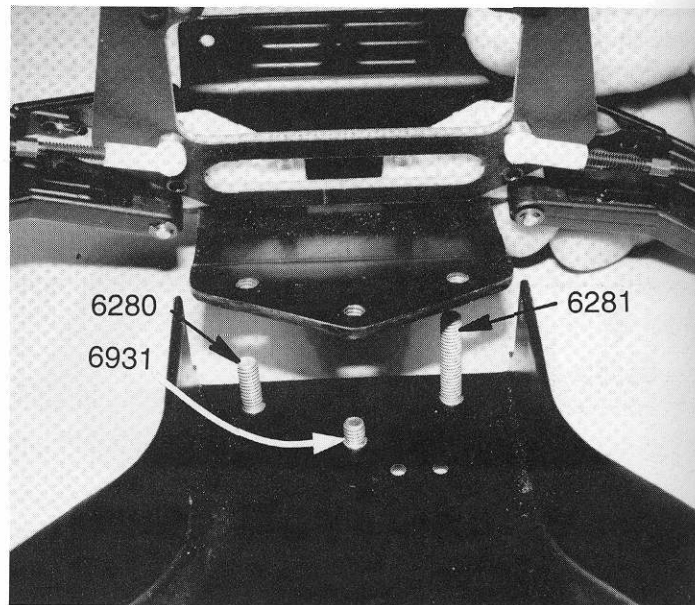


#6280  
8-32 x 1/2  
aluminum



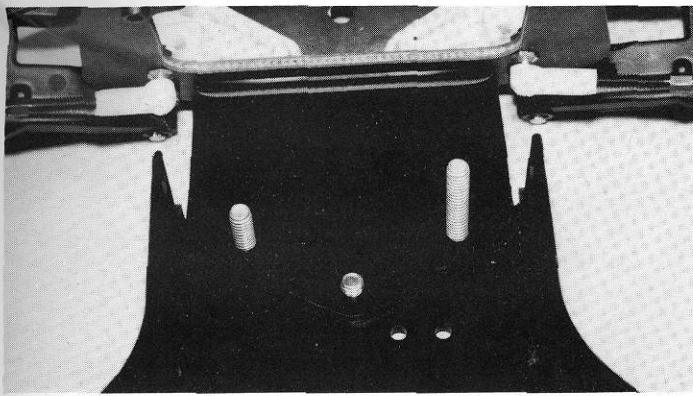
#6931  
8-32 x 1/4  
steel

**Fig. 23**



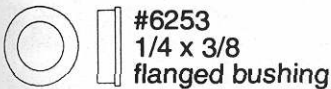
#6281  
8-32 x 7/8  
aluminum

**Fig. 24**



**Fig. 25**

□ **Fig. 26** Now go back to bag #6-2 and remove the four #6253 1/4" x 3/8" flanged bronze bushings, and two #6254 nylon bell crank steering arms with their nylon sleeve nut inserts. **Note:** Your production #6254 bell crank steering parts will be white, not black, as shown in the photos. Press one of the #6253 bronze bushings into each side of the two steering arms. **Note:** #6252 is a complete bell crank steering replacement kit.



**Fig. 26**

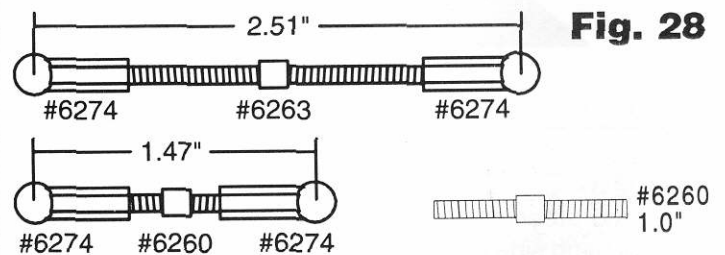
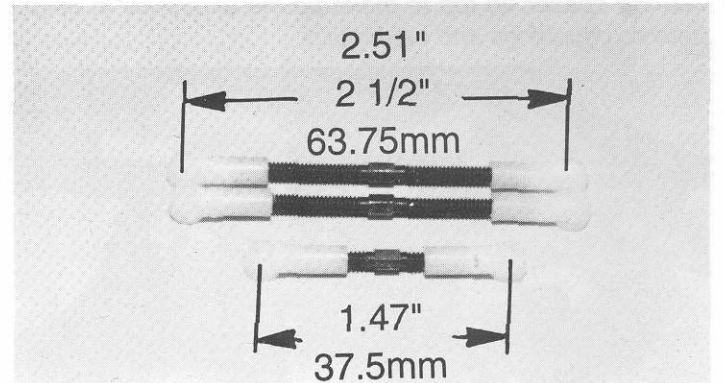
□ **Fig. 27** In bag #6-14 you will find five #6270 short steel ball ends. Thread the ball ends into the bell crank steering arms as shown. No nuts are needed for these ball ends.



**Fig. 27**

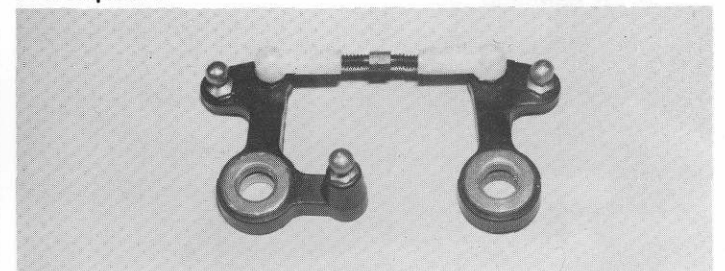
□ **Fig. 28** Remove the two #6263 2.06" length turnbuckles and one #6260 1.0" turnbuckle from bag #6-2. Now remove six of the #6274 plastic ball end caps from bag #6-14 and thread them evenly onto the turnbuckles. The plastic ball end caps will all face the same way on these turnbuckles.

Adjust the length of the small turnbuckle from center of ball hole to center of ball hole to 1.47" (1 15/32" or 37.5mm). Then adjust the two longer steering turnbuckles to 2.51" (2 1/2" or 63.75mm) center to center length.



**Fig. 28**

□ **Fig. 29** Take the short turnbuckle tie rod and snap it onto the bell crank steering arms as shown. You may need to use pliers.

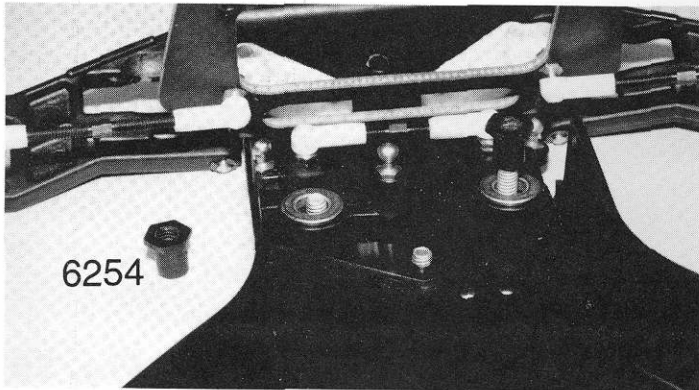


**Fig. 29**

□ **Fig. 30** (1) Install the #6254 bell crank steering assembly loosely over the two aluminum screws that are holding the nose plate to the chassis. (2) Next, thread the two #6254 nylon sleeve insert nuts (from fig. 26) onto the #6280 and #6281 aluminum screws. **Note:** The sleeve nut is not threaded, so you will be making your own threads as you go. (3) Now go ahead and thread the right hand sleeve nut onto the #6281 screw. Make sure it lines up and slides inside the bushings of the right hand bell crank steering arm as it goes down. (4) Then lightly tighten it against the nose

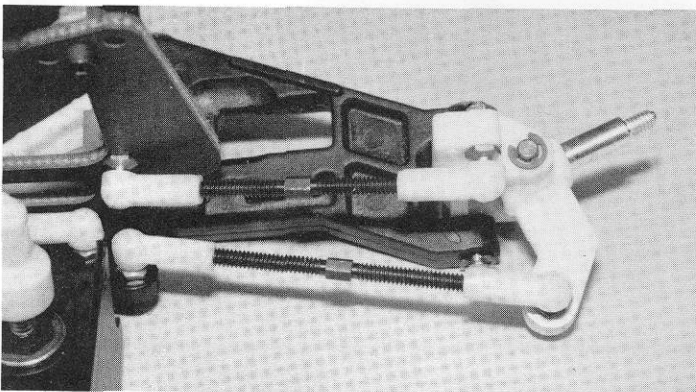


plate and then back the sleeve nut off 1/4 of a turn. (5) Do the same for the left hand sleeve insert nut and bell crank steering arm. (6) Now check the movement of the bell crank steering. It should move back and forth smoothly with no binding. If the steering is still binding, you can back off the sleeve nuts a little more to free up the steering. Just don't go too far or it will get sloppy. **WARNING!** This is a non-servo saver steering system. Your servo may require the use of a servo saver. This will be discussed during the steering servo installation. section. **Racer's Tip:** You can replace the four #6253 bushings with four #897 1/4 x 3/8" flanged ball bearings for reduced maintenance, but you will need a #6254 bearing spacer on top to make up the difference in height between bushings and bearings.

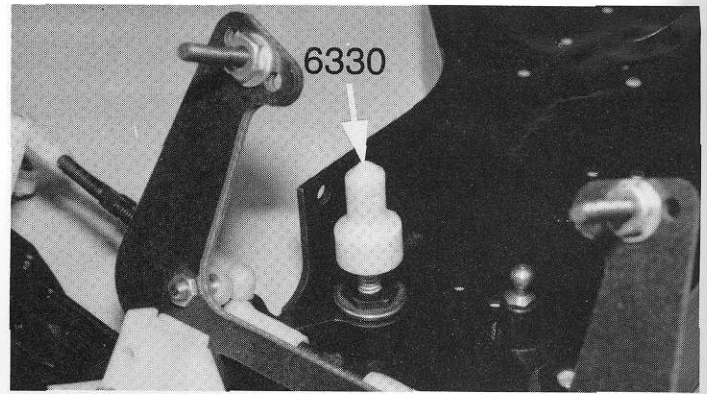


**Fig. 30**

□ **Figs. 31 & 32** Now go ahead and install one of the #6263 steering turnbuckles assembled in fig. 28 onto the right hand side steel ball ends on the #6221 nylon steering arms, and on the #6254 nylon bell crank arms (fig. 31). Do the left hand side. In bag #6-5 remove the #6330 body mount. Thread this onto the driver's right side screw as shown in fig. 32.

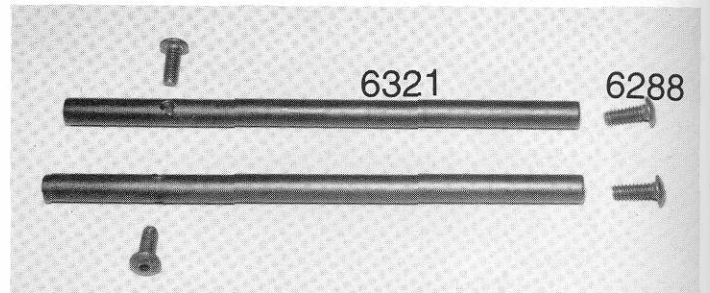


**Fig. 31**



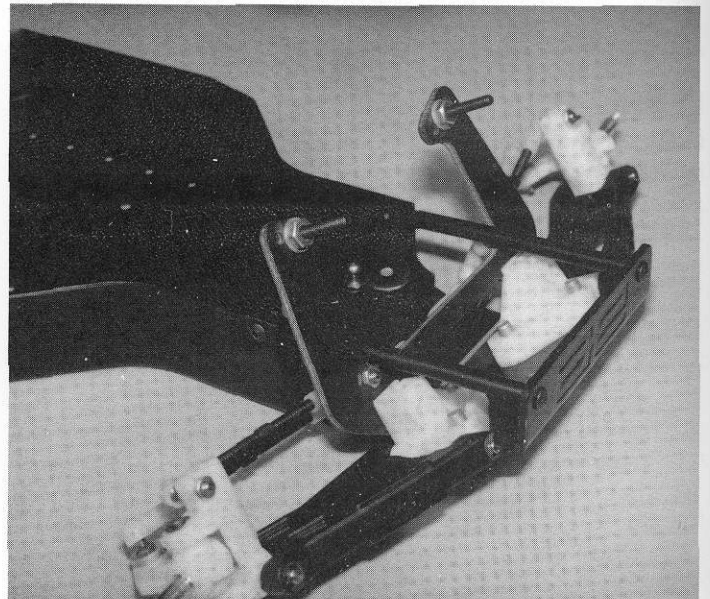
**Fig. 32**

□ **Figs. 33 & 34** In bag #6-4 you will find two #6321 black anodized nose brace tubes and four #6288 4-40 x 1/4" BHSScrews. One end of each nose brace tube has a tapped hole through the side, and the tube itself is tapped at the other end. There are two holes in the front of the nose plate; insert two of the #6288 BHSScrews and then thread them into the tapped end of the nose brace tube. Do not completely tighten these screws just yet. Now using the two remaining #6288 screws, mount the nose brace tubes to the chassis sides as shown in fig. 34. Once all four screws are threaded on, you can go back and tighten them.



#6288  
4-40 x 1/4

**Fig. 33**



**Fig. 34**

# STEALTH TRANSMISSION ASSEMBLY

We feel this transmission is the best in the world. Our Stealth transmission has been responsible for three of our four IFMAR 1:10 Off Road World Championship wins plus ten National Title wins in buggy and truck. 1993 proved to be one of our best years, with Brian Kinwald winning the IFMAR Off Road Worlds in Basildon, England; the 1993 ROAR 2WD Modified Nationals in Fountain Valley, CA; and the 1993 ROAR Truck Nationals in Grand Rapids, MI. Your new car has this same race-proven transmission. We know this combination will also help you greatly improve your performance, depending, of course, on how well you assemble and maintain your transmission. So take your time and assemble it to the best of your ability.

**Note:** The Stealth transmission uses finely engineered materials. No lubrication is required except where indicated. Using oils or similar lubricants inside the transmission can reduce its performance or cause parts failure. Excessively lubricating the ball bearings in the transmission case or diff assembly can cause the same problems.

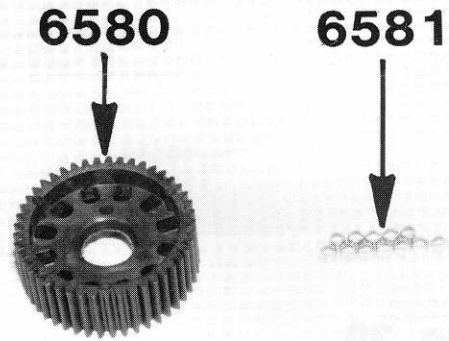
□ **Figs. 35, 36 & 37** Open the Stealth transmission bag and locate bag A (the diff assembly). (1) From bag A remove the #6580 diff gear and the bag containing the twelve #6581 3/32" carbide diff balls. These are the larger of the two ball sizes. These carbide balls are the best available. They will outlast the diff drive rings at least ten times (if the diff is kept clean and lubed).

**WARNING! NEVER replace these balls with any other balls except our #6581 carbide diff balls, for our tolerances are tighter than most other suppliers'. Due to tight tolerances and careful packaging of matched balls, when replacing lost or worn 3/32" diff balls, you MUST replace ALL 3/32" balls at the same time with new balls from the same package. This means you cannot even mix balls from two separate #6581 packages.**

(2) Look at the center hole of the #6580 diff gear; if there is any flash inside the hole, then you will need to remove it. Carefully trim any excess flash from the center bearing hole with the very tip of your X-acto© knife (the tip will turn easiest when removing the flash) to make sure you do not remove any of the gear itself.

(3) From the Stealth transmission bag remove the #6591 Stealth white silicone diff lube. Another word of caution. DO NOT substitute any other type of diff lube on the balls. It took us countless hours of testing to find the correct silicone diff lube to make the diff work correctly. Do yourself a favor: use what comes in this kit!

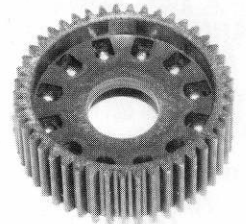
(4) Fill the twelve ball holes in the diff gear with Stealth white silicone diff lube and then (5) push the twelve #6581 3/32" balls into the holes. (6) Wipe the excess lube back into the ball holes with your finger. Fig. 37 shows your completed gear. (7) Carefully clean all of the silicone diff lube from your hands.



**Fig. 35**

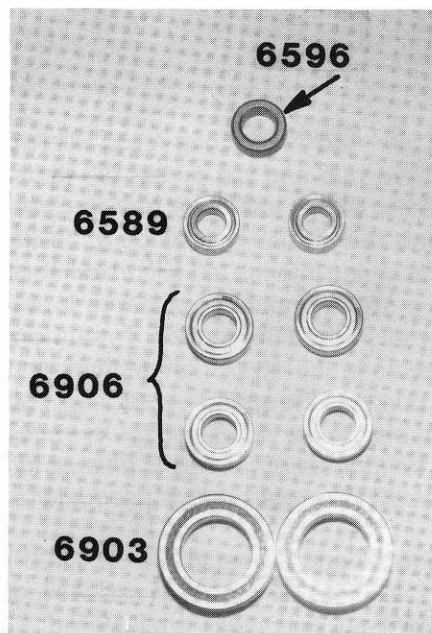


**Fig. 36**



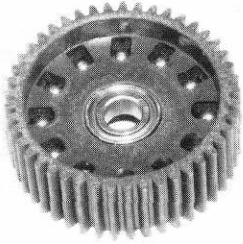
**Fig. 37**


□ **Figs. 38 & 39** Next open bag B which came from the Stealth transmission bag. In this bag you will find a total of eight bearings and one bushing. Take out the two smallest #6589 bearings. These have an outside diameter of 5/16" and an inside diameter of 5/32". Place one inside the center hole of the #6580 diff gear as shown in fig. 39. Set the second #6589 bearing aside, because we will be using it shortly.



**Fig. 38**






**#6589**  
 5/32 x 5/16  
 unflanged bearing

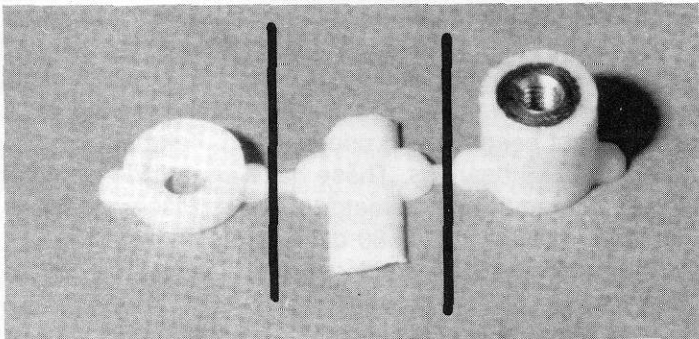
**Fig. 39**

**Fig. 40** In bag A you will find the #6575 T-nut and diff thrust bolt cover as shown in fig. 40. Remove the T-nut (which has a steel insert molded into it) from the nylon runner. **WARNING!** Make certain that you do not cut off the "ears" on the T-nut or the thrust bolt cover. Trim the diff thrust bolt cover off the same molding tree and set it aside. We will use it in fig. 77.



Do not cut the "ears" off the T-nut

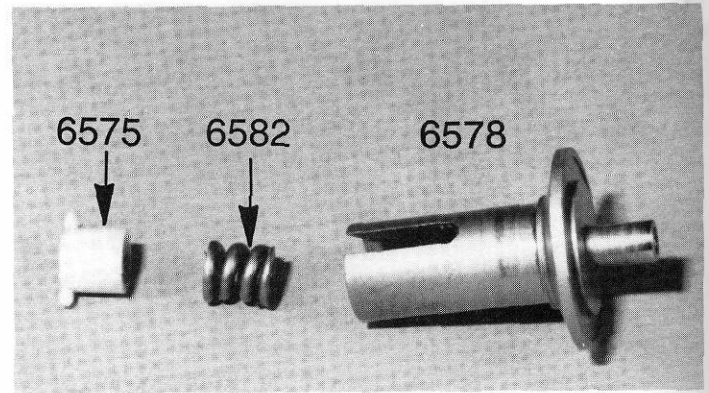
(NOT ACTUAL SIZE)



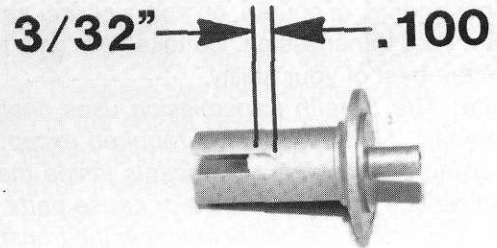
**Fig. 40**

**Figs. 41, 42 & 43** Also in bag A you will find the #6578 left diff outdrive hub and the #6582 diff thrust spring. Make sure that the #6578 left drive hub is clean and free of all burrs and residue on the inside and outside. Carefully install the spring into the left diff drive hub; it should go in with only a slight amount of pressure to the bottom of the slot. Now align the #6575 nylon T-nut (from the last step) with the slots in the #6578 left diff hub, and push in the T-nut until it contacts the spring, steel inset end first. **WARNING!** Do not mix up the #6582 diff thrust spring with the #6587 torque control spring in bag E (this spring has a slightly larger outside diameter) that is used later in the manual.

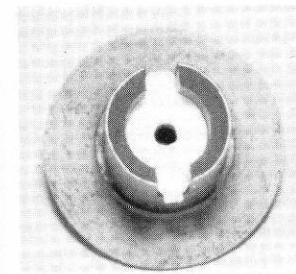
There should now be approximately a 3/32" (.100") gap where shown in fig. 42. Fig. 43 shows an end view of the left diff drive hub after T-nut and spring are installed.



**Fig. 41**

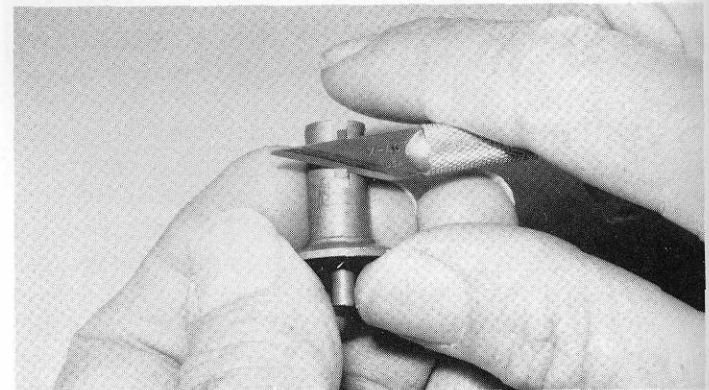


**Fig. 42**



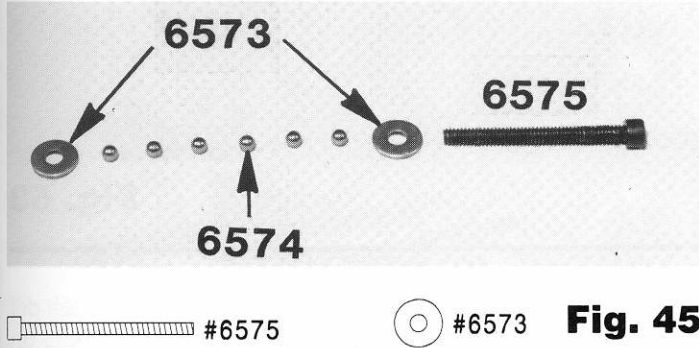
**Fig. 43**

**Fig. 44** Take your X-acto® knife and trim off any of the plastic T-nut that extends outside of the slots in the outdrive hub as shown. This is necessary so that it will fit through the bearing when we install it in the case later on.



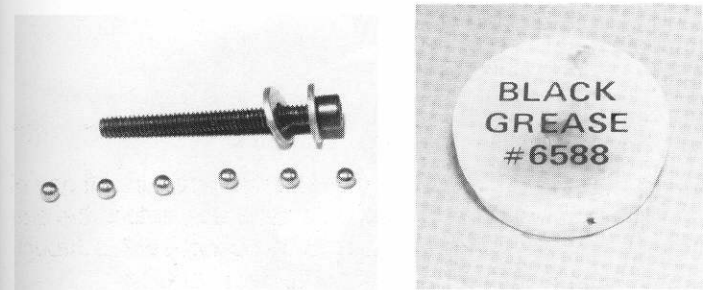
**Fig. 44**

❑ **Figs. 45** In bag A you will find a little bag containing the six smaller #6574 5/64" precision thrust balls. In another little bag you will find the #6575 2-56 x 1" diff thrust bolt and the two #6573 diff thrust washers. **WARNING! NEVER replace your thrust balls with any other balls except our #6574 thrust balls. Our tolerances are tighter than most other companys'. Due to these tight tolerances and careful packaging of matched balls, when replacing lost or worn 5/64" thrust balls, you MUST replace ALL 5/64" balls at the same time with new balls from the same package. This means you cannot even mix balls from two separate #6574 packages.**



❑ #6575      ○ #6573      **Fig. 45**

❑ **Figs. 46 & 47** Slip the two #6573 diff thrust washers onto the #6575 diff thrust bolt as shown. Locate your container of #6588 black grease in the Stealth bag. Now place a small amount between the two #6573 thrust washers (just enough to hold the six balls in place). **WARNING! Do not use the #6591 Stealth diff lube on these balls.**

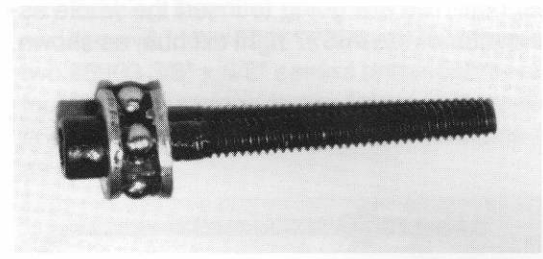


**Fig. 46**      **Fig. 47**

❑ **Fig. 48** Now place the six #6574 thrust balls between the two #6573 thrust washers (the black grease should hold them in place for you). **Note: Make sure you have all six balls installed between the washers, because more balls will cause the diff to loosen up and less can cause the thrust washers to crack.**

**Cliff Lett's Racer's Tip:** "Installing the differential thrust bearing assembly can be a pain, but try it this way: slide one of the thrust washers onto the screw and put some black grease on the washer. Put all six thrust balls in a straight line in one of the lines on the palm of your hand. Hold the

threaded end of the screw and roll the greased washer along the row of balls, picking up the balls one at a time until they are stuck to the washer in a neat circle. Install the second washer onto the screw."



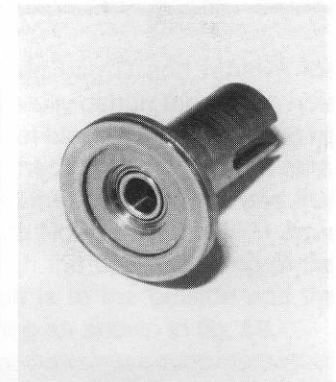
**Fig. 48**

❑ **Figs. 49 & 50** Now take the #6577 right diff drive hub and one #6579 diff drive ring from bag A. Also take the second #6589 5/32" x 5/16" unflanged ball bearing from bag B. **Make sure that the #6577 right diff hub is clean and free of all burrs and residue on the inside and outside.** (Fig. 49 shows both parts that will go on the #6577 right diff hub and fig. 50 shows both parts installed). The #6589 bearing will go inside the cavity in the #6577 right diff hub. They should just push in with your finger. **Never force them in!** Now place the #6579 diff drive ring onto the right diff hub. **Racer's Tip:** The Team drivers always check the diff drive rings for the side that is more rounded on the edge and place this side against the hub. This allows the diff to work better.

Your completed hub assembly should look like fig. 50. **DO NOT** try to pin the drive ring to the hub. This hub is designed to lock the drive ring without pinning. Leave AS IS.



**Fig. 49**

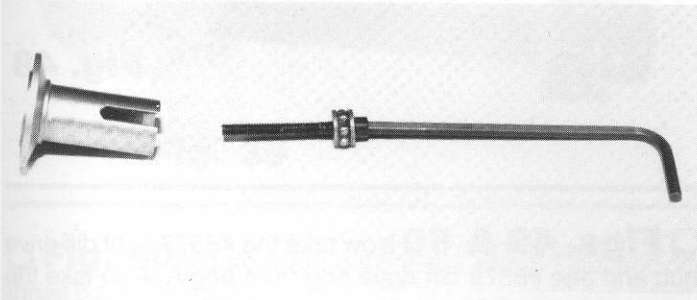


**Fig. 50**

○ #6589  
5/32 x 5/16  
unflanged bearing

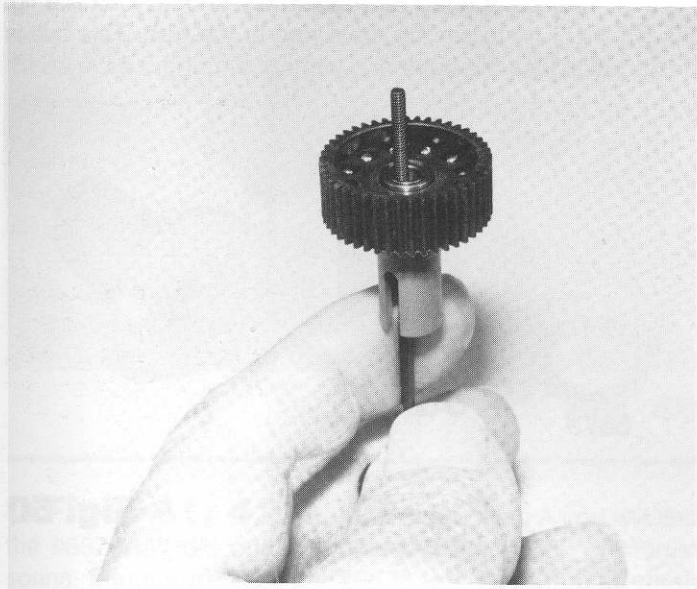


□ **Fig. 51** Locate your 5/64" Allen wrench from your #6950 tool bag. Now slip the long end into the head of the #6575 diff thrust bolt. You are going to insert the whole assembly into the center of the #6577 right diff hub, as shown.



**Fig. 51**

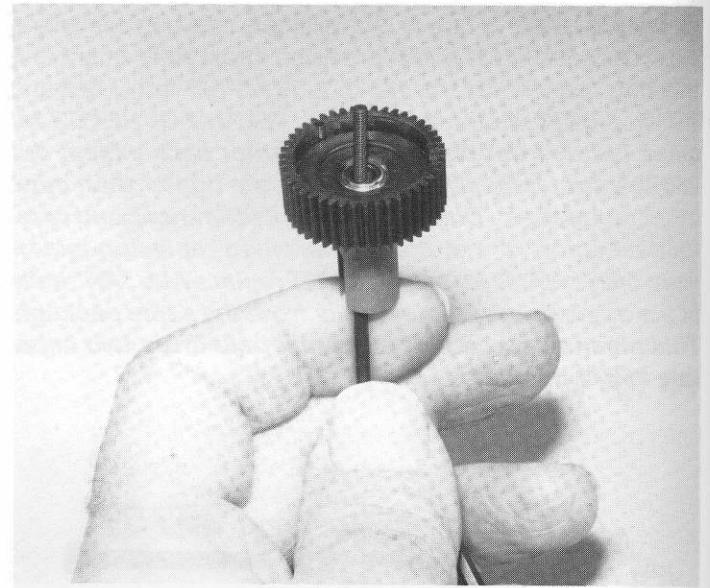
□ **Fig. 52** With the Allen wrench still in the diff bolt, turn the hub assembly upright so that the wrench is on the bottom. Make sure that the #6579 diff drive ring is still on and centered. Now pick up the #6580 diff drive gear (with the balls and bearing still installed) and slip it over the #6575 diff thrust bolt onto the drive ring and hub.



**Fig. 52**

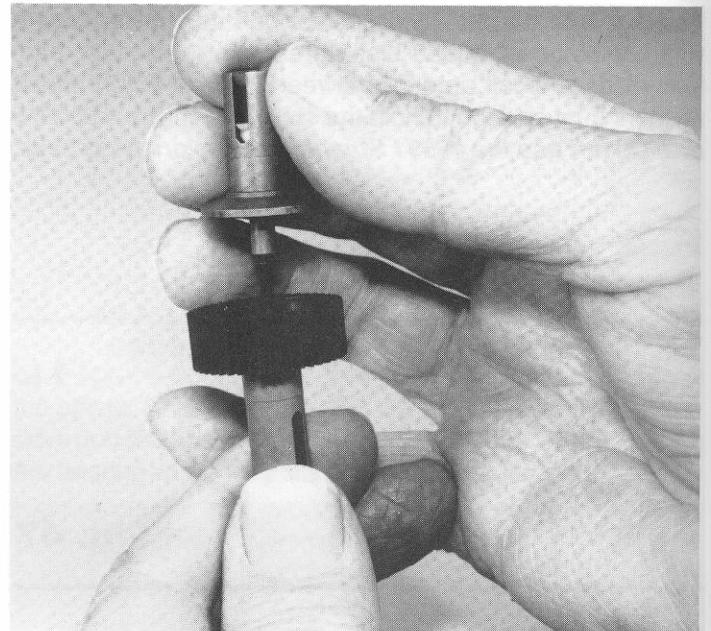
□ **Fig. 53** Now take the second #6579 diff drive ring from bag A and put it on top of the diff gear over the diff balls and center it as best as you can. Remember, if you are doing the racer's setup, the rounded side will be up. **WARNING!** If you remove the gear at any time before you completely assemble the diff halves, always double check to make sure you do not have both drive rings on the same side. This can be easy to do because one of the drive rings may stick to the diff gear and the other could be stuck to the

diff outdrive hub on the same side.



**Fig. 53**

□ **Fig. 54** Now we are going to install the #6578 left diff drive hub assembly over the #6575 diff bolt until it seats on the #6579 diff drive ring. IT IS VERY IMPORTANT that you make sure that the hub centers on the diff drive ring.

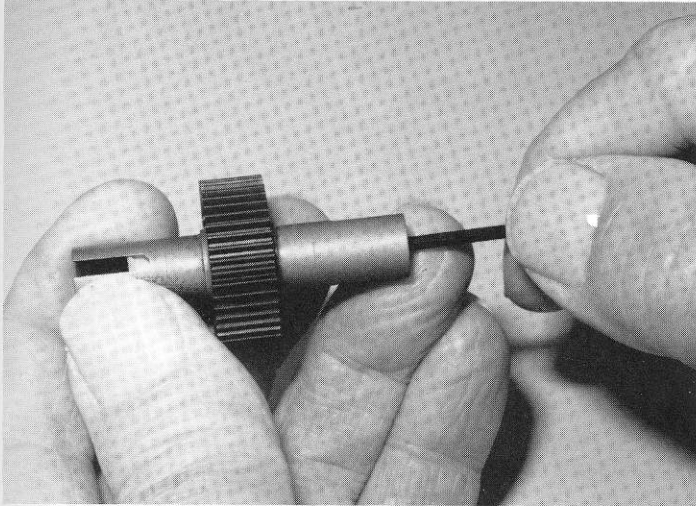


**Fig. 54**

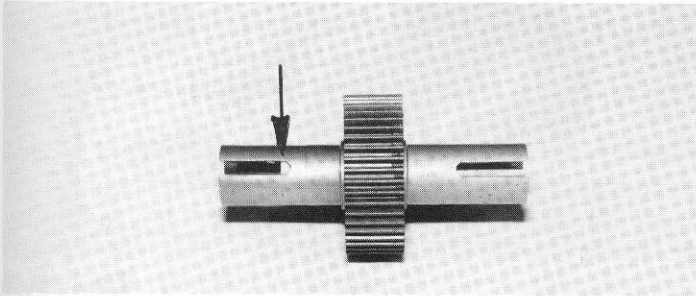
□ **Figs. 55 & 56** Tighten the diff bolt using the Allen wrench, making sure that the hubs and diff drive rings stay centered. Now turn the diff assembly sideways, as shown, and tighten the diff screw until the spring collapses fully and the screw bottoms out. **DO NOT OVERTIGHTEN!** Correct adjustment is bottoming out the spring and bolt and then backing off the screw 1/8 to 1/4 of a turn.

As you are tightening the diff bolt, you will notice the ears on the T-nut (marked by the arrow) moving closer and closer to the bottom of the slot in the diff hub. The spring and diff bolt should bottom out at about the same time as the T-nut ear reaches the bottom of the slot, but if not, just make sure you bottom out the spring and bolt. Once you feel the spring and bolt bottom out, then you can back off the bolt 1/8 to 1/4 of a turn.

Your diff should operate very smoothly when turning the hubs in opposite directions. (Smoothly does not mean "free spinning". The parts will feel firmly held together but the motion will feel smooth, not rough.) After you have run the car once, recheck the diff setting. There is never a need to adjust the diff in any other way.

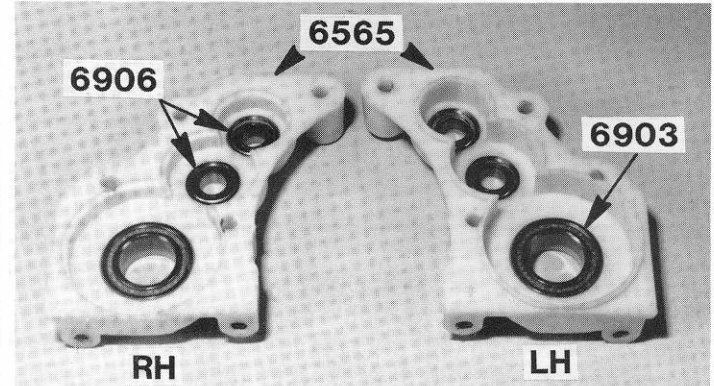


**Fig. 55**



**Fig. 56**

□ **Fig. 57** Open bag C and remove the #6565 left and right transmission case halves. Make sure that you remove any flashing from the case halves. Now go back to bag B and remove four #6906 3/16" x 3/8" unflanged bearings and two #6903 3/8" x 5/8" sealed unflanged bearings. Install the four #6906 bearings in the four small cavities and the two #6903 bearings in the larger cavities inside the case halves as shown.

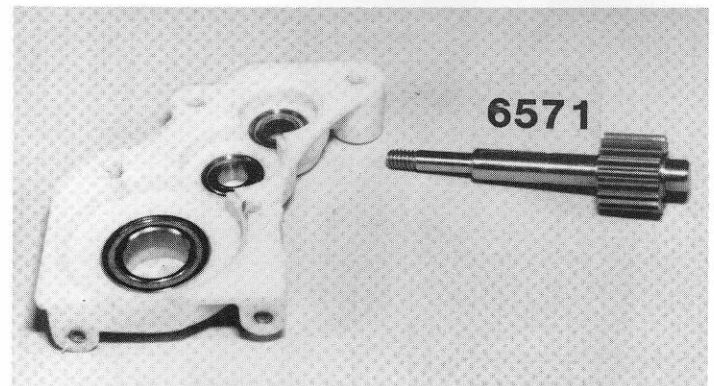


○ #6906  
3/8 x 3/16  
unflanged bearing

**Fig. 57**

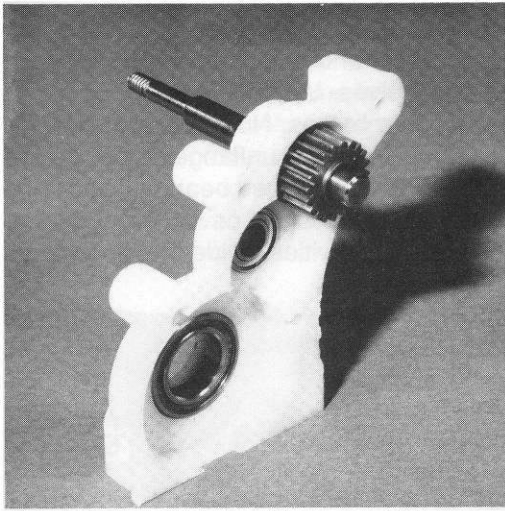
○ #6903  
3/8 x 5/8  
unflanged bearing

□ **Figs. 58 & 59** Open bag D and remove the #6571 drive gear assembly. Carefully deburr the roll pin hole in the drive gear so the hole is not blocked and there are no raised edges around the hole. Check both sides of the hole. We are doing this to make sure the roll pin will fit and that the bearing will slide on the shaft. Now take the #6571 drive gear and insert the shaft through the upper bearing of the right case half so that the shaft is to the outside and the gear is inside against the bearing as shown in fig. 59.



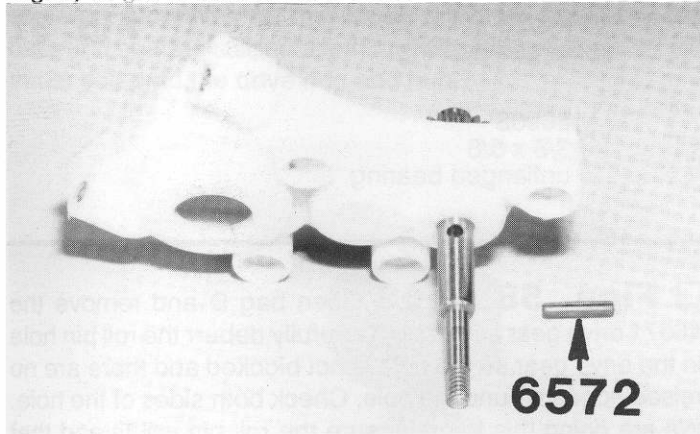
**Fig. 58**



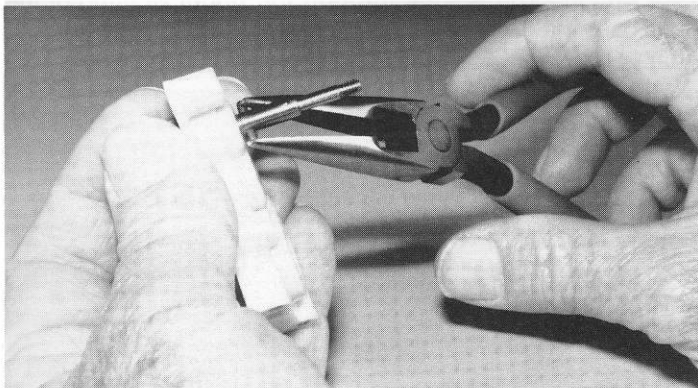


**Fig. 59**

□ **Figs. 60 & 61** Open bag E and remove the #6572 1/16" roll pin. Now using a pair of needle nose pliers, squeeze the roll pin into the hole in the #6571 drive shaft and center the pin. You may need to squeeze the roll pin slightly to get it started in the hole.

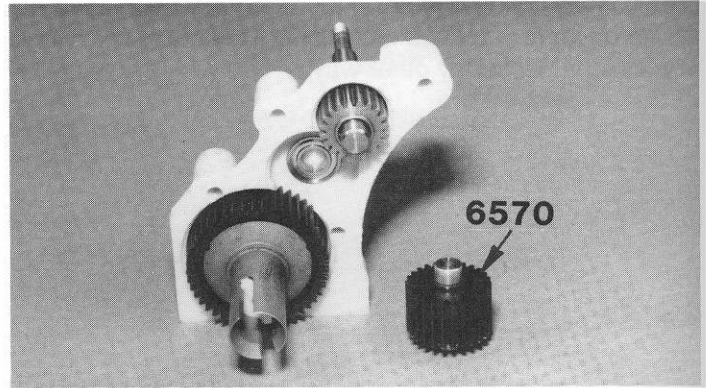


**Fig. 60**

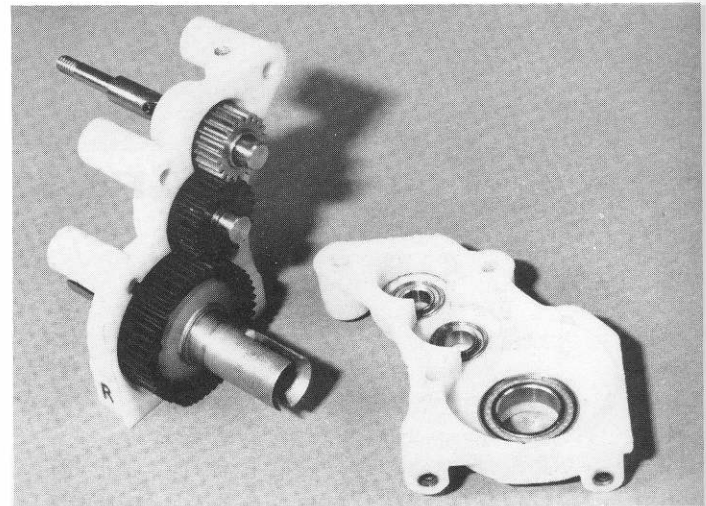


**Fig. 61**

□ **Figs. 62 & 63** Install the assembled diff into the right case half lower bearing as shown in fig. 60. Make sure that you install the diff bolt head side through the right case half. **Note:** If you install the bolt head so that it is on the driver's side of the transmission, you may have a problem with the diff backing off. Locate the #6570 idler gear and shaft from bag D and install it into the center bearing of the right case half. There is no right and left gear side, so it can go in either way.

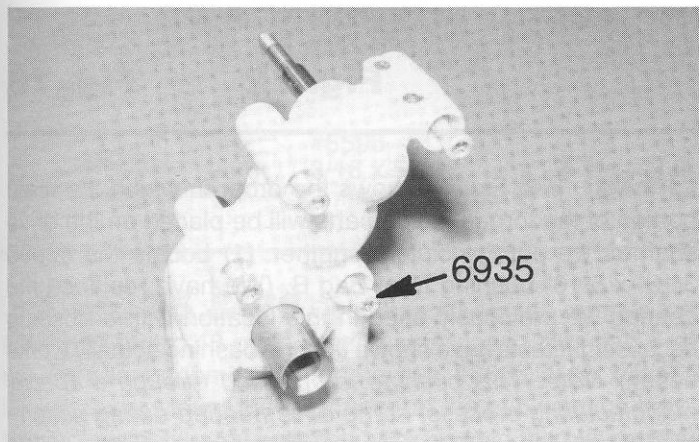


**Fig. 62**



**Fig. 63**

□ **Fig. 64** Take the left hand case half and install it over the gears, making sure that each gear fits correctly into the appropriate bearing. Now open bag F and take out the four #6935 4-40 x 1" aluminum SHCScrews. Thread them into the four bolt hole locations on the left hand case. Screw in the bolts so that they extend about 1/8" out of the right hand case half.

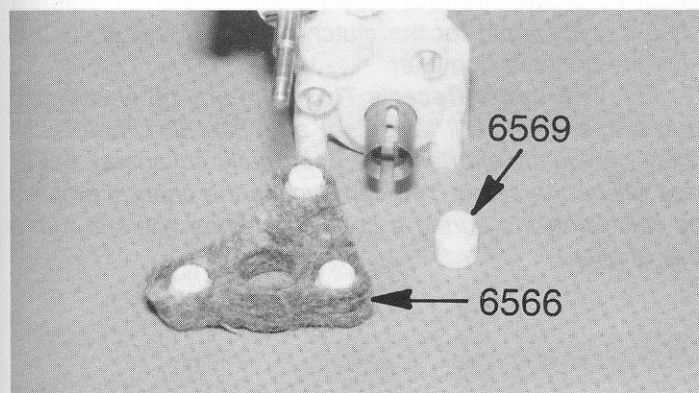



 #6935  
 4-40 x 1  
 aluminum

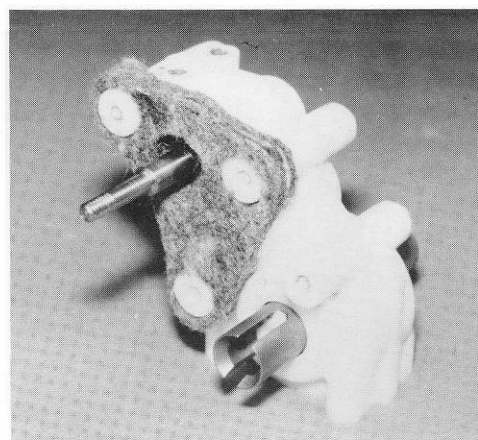
**Fig. 64**

□ **Figs. 65 & 66** Back in bag C you will find four #6569 motor plate spacers, and one case dust end cap on a small molded parts tree. Remove the five parts from the tree. Now set the end cap aside; we will use it in a few moments. In bag F you will find the #6566 felt dust seal. Carefully remove the cutouts from the felt seal so that we can install three of the #6569 motor plate spacers into the appropriate holes as shown. Install the spacers so that the small ends will go into the case holes on the right case half as shown in fig. 66.

Install the #6566 felt seal and spacers over the drive shaft and onto the case as shown. The spacers will also be going over the threaded ends of the four #6935 aluminum case screws. Now install the remaining motor plate spacer in the fourth case hole as shown.

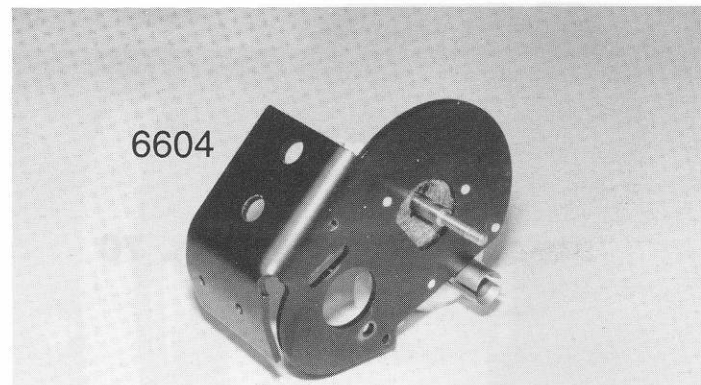


**Fig. 65**



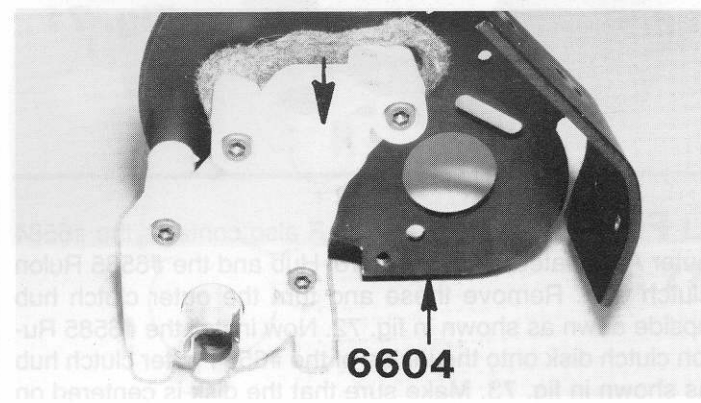
**Fig. 66**

□ **Figs. 67** Now take the #6604 black anodized motor mounting plate from the Stealth main bag. Secure it to the right hand tranny case on the motor plate spacers using the #6935 screws already installed in the left case half. Tighten all four bolts. **WARNING! These are aluminum screws, so make sure all four screw threads are started into the motor plate before you begin to tighten the screws. Aluminum screws can strip their threads very easily.**



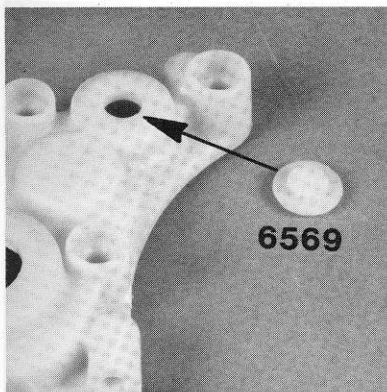
**Fig. 67**

□ **Figs. 68 & 69** Now take the #6569 case dust end cap that we set aside in fig. 64 and install it in the hole of the left case half as shown in these photos. The location is indicated by the arrows.



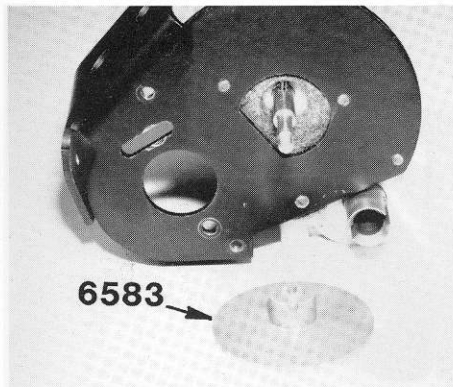
**Fig. 68**



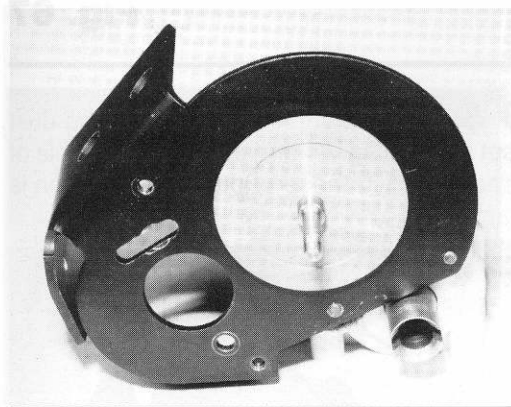


**Fig. 69**

□ **Figs. 70 & 71** Now we are going to start assembling the Associated Torque Control assembly. From bag E remove the #6583 inner torque control hub (with the slot on the back side as shown in fig. 70). Slide the inner clutch hub over the gear shaft so that the hub aligns with and then slides over the drive shaft roll pin, as shown in fig. 71.

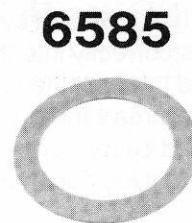


**Fig. 70**

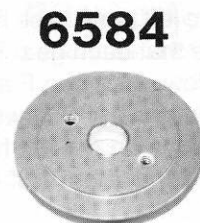


**Fig. 71**

□ **Figs. 72 & 73** Bag F also contains the #6584 outer Associated Torque Control Hub and the #6585 Rulon clutch disk. Remove these and turn the outer clutch hub upside down as shown in fig. 72. Now install the #6585 Rulon clutch disk onto the inside of the #6584 outer clutch hub as shown in fig. 73. Make sure that the disk is centered on the clutch hub.



**Fig. 72**



**Fig. 73**

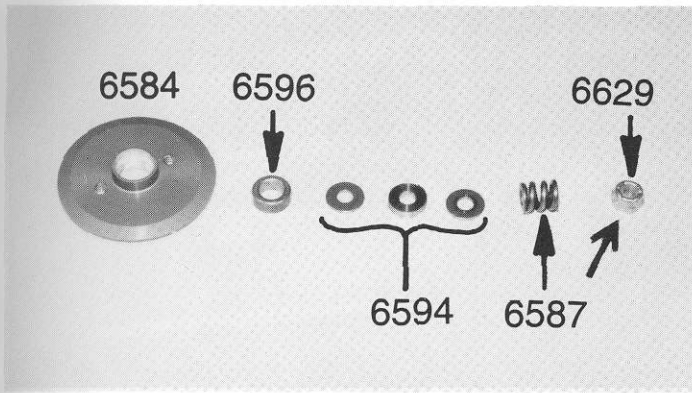
□ **Fig. 74** Fig. 74 shows the order in which the main portion of the torque clutch parts will be placed on the drive shaft as we put the clutch together. (1) Locate the #6596 3/16" x 5/16" bushing from Bag B. (We have replaced the bearing we previously used in this location with a bushing because our tests have shown that the bushing actually works better.) **Note:** This bushing is pre-oiled through a special manufacturing process, so no oil is needed during assembly. (2) Install the #6596 bushing inside the hole of the #6584 outer clutch hub.

(3) Next, install the clutch hub with the bushing and clutch disk onto the gear shaft, the clutch disk still centered on the hub. Make sure that the bushing goes onto the larger portion of the gear shaft and that it is slightly below the surface of the clutch hub when properly installed.

(4) From bag E remove the #6594 thrust bushing and two thrust bushing washers. You can also remove the #6587 torque control spring and #6629 gold colored 5-40 locknut at this time. **Note:** Associated's #6687 contains both the torque clutch spring and one #6629 gold 5-40 locknut. (5) Take one of the thrust bearing washers and slide it onto the drive shaft. (6) Now install the bronze thrust bushing and the second steel thrust bushing washer. **WARNING!** Don't mix up the special hardened steel thrust washers from bag E with any other washers. Using any other washers from the kit will possibly ruin the clutch assembly or thrust bearing.

(7) Now install the #6587 torque control spring and #6629 gold colored 5-40 locknut. (8) Tighten the nut until about 1/2 of one thread is showing outside the nut. This is a good starting point for the clutch adjustment until we fine tune the transmission later.

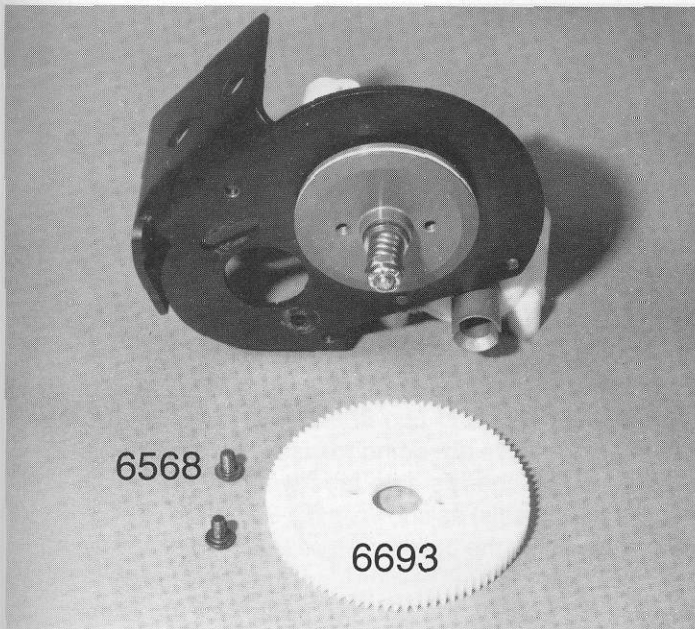
**Cliff Lett's Racer's Tip:** "Like any other spring, a new slipper spring will 'take a set' after use. This means that it will be slightly shorter after being fully collapsed, but its rate will be the same. You can bypass the change problem by collapsing the spring a couple of times yourself with a pair of pliers."



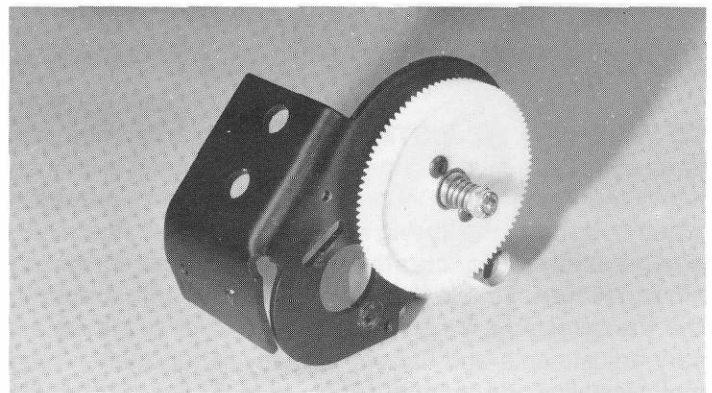
 #6629  
5-40 locknut
  #6596  
3/16 x 5/16  
unflanged bushing

**Fig. 74**

**Figs. 75 & 76** Open bag #6-15 and remove the #6693 81 tooth, 48 pitch Stealth spur gear. From bag F of the Stealth transmission locate two #6568 4-40 x 3/16" BHCScrews. Mount the spur gear on the hub with the large flat center section towards the hub. Line up the two mounting holes in the spur gear with the two mounting holes in the gear hub, and install the screws. Your installed spur gear should look like fig. 76 when properly secured.



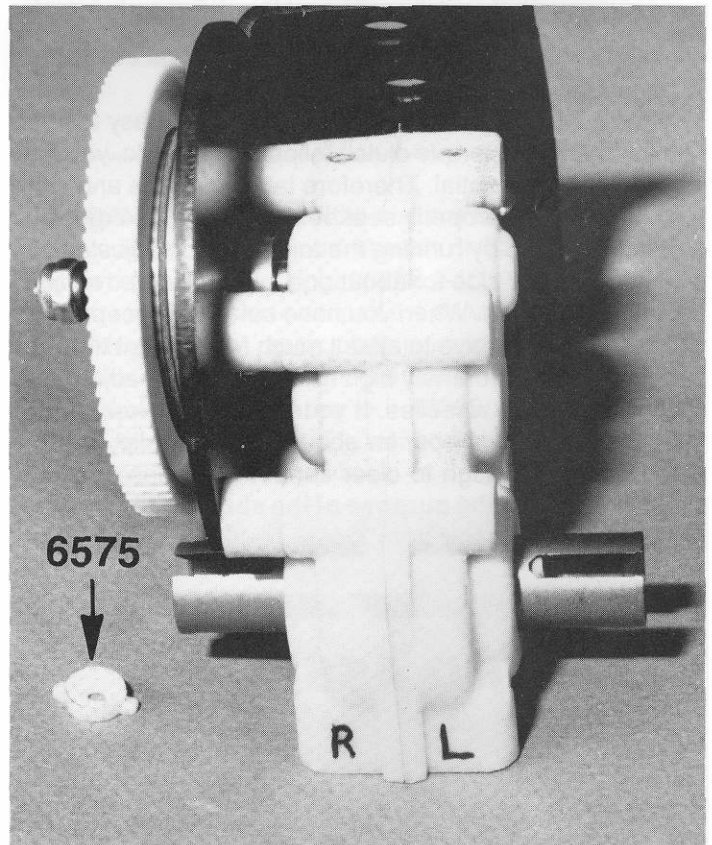
**Fig. 75**



 #6568  
4-40 x 3/16

**Fig. 76**

**Fig. 77** Locate the #6575 diff thrust bolt cover we set aside in the figs. 38 & 39 step. On the right diff hub install the diff thrust bolt cover (flat side out). Push the thrust bolt cover in until it bottoms out in the outdrive hub. **Note:** *If at any time you go back to standard dogbones, you must install one #6372 dogbone spacer in each outdrive hub for correct spacing.*



**Fig. 77**



## TEAM DRIVER RACING ADJUSTMENTS IMPORTANT — PLEASE READ

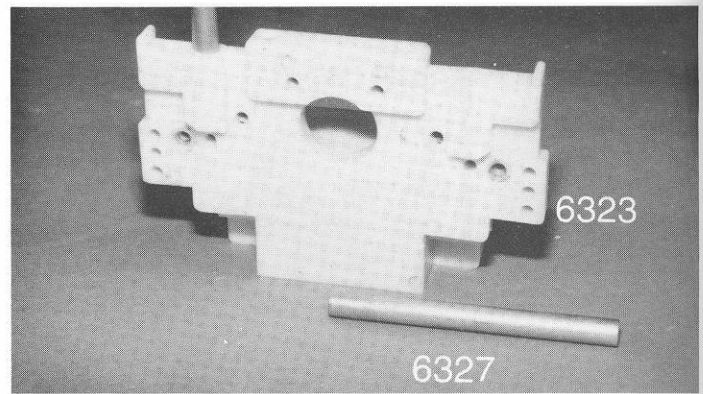
**DIFFERENTIAL ADJUSTMENT.** Once the differential has been correctly adjusted, there should be no need to change it until rebuilding time. **Be very careful not to overtighten when bottoming the spring and screw during adjustment, and be extremely accurate when backing the screw out 1/8 to 1/4 turn. This is the most important adjustment in the transmission.** When you have made all of the necessary adjustments and the car is ready to run (battery and motor installed and charged), apply a small amount of throttle while holding one of the rear wheels stationary. Do this for about 15 seconds. This will correctly seat all of the differential parts. Now recheck the differential adjustment.

You should rebuild the differential when the action gets somewhat "gritty" feeling. Usually cleaning and applying new lube per instructions will bring it back to new condition. The tungsten carbide diff balls (which are standard parts) should very rarely need changing. Normally as the parts seat, the diff will get smoother. If after carefully cleaning and re-lubing the diff parts, the diff still feels gritty, the parts should be replaced in this order: #6574 diff thrust balls, #6573 diff thrust washers, #6579 diff drive rings. Then, only after everything else has been replaced, the #6581 3/32" carbide diff balls should be checked and possibly replaced.

**TORQUE CLUTCH ADJUSTMENT.** It is very easy to overtighten or lock the torque clutch (slipper). If you do, you may damage the differential. Therefore take your time and allow the clutch disc to properly seat before adjusting to race setting. This is done by running the torque clutch adjustment a little on the loose side for about one minute before readjusting to race settings. When you have set the slipper properly you really will not have to alter it much for different tracks. If your track is an extremely high traction surface, adjust your slipper to prevent wheelies. If your track has a low traction surface, adjust the slipper for about two feet of slip, or make sure it is tight enough to clear certain obstacles (doubles, etc.). **Remember, the purpose of the clutch is to gain traction, not to break the tires loose.**

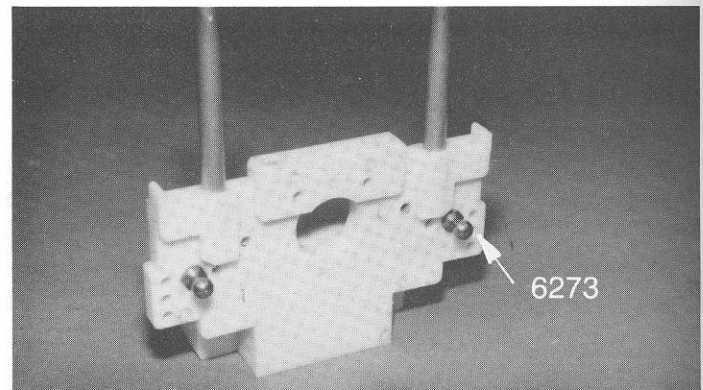
## REAR END ASSEMBLY

□ **Fig. 78** In bag #6-4 you will find the #6323 nylon rear bulkhead and the two #6327 aluminum wing tubes. If the edges of the wing tubes are sharp, round them off with a file so that they will go into the rear bulkhead easier. You may have to tap the tubes into the bulkhead so that they will fit.



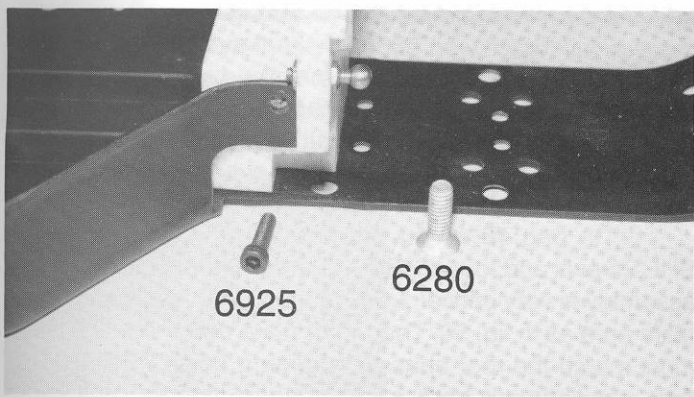
**Fig. 78**

□ **Fig. 79** Remove two #6273 long steel ball ends from bag #6-14. We are going to install these into the rear bulkhead from the back side. There are five mounting holes on each side of the bulkhead for the tie-rod locations. You are going to use the middle of the top three holes as shown.

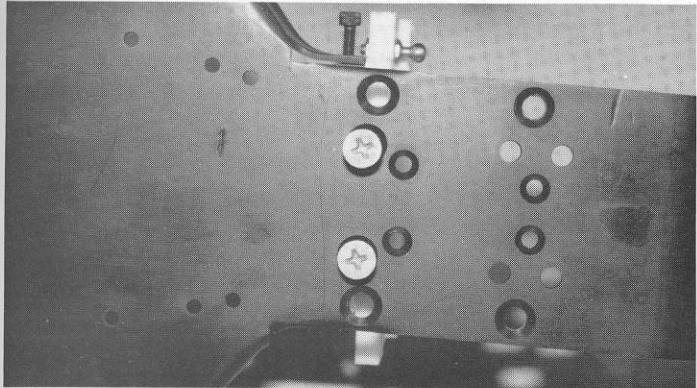


**Fig. 79**

□ **Figs. 80 & 81** Take two #6280 8-32 x 1/2" aluminum FHMScrews and two #6925 4-40 x 1/2" SHCScrews from bag #6-4. We are going to insert the rear bulkhead between the two chassis side tabs (with the ball ends to the back of the chassis) as shown in fig. 80. Install the two #6925 4-40 screws into the bulkhead through the sides of the chassis, but do not tighten them down yet. Now thread the two #6280 8-32 screws through the bottom of the chassis into the bulkhead. (See fig. 81). Do not tighten them down yet; we will tighten these four screws later in the instructions.

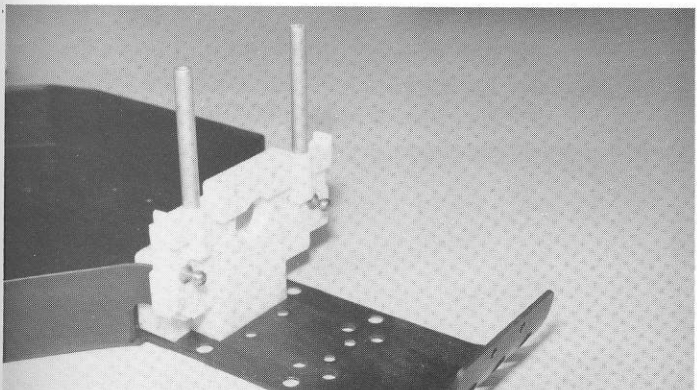


**Fig. 80**



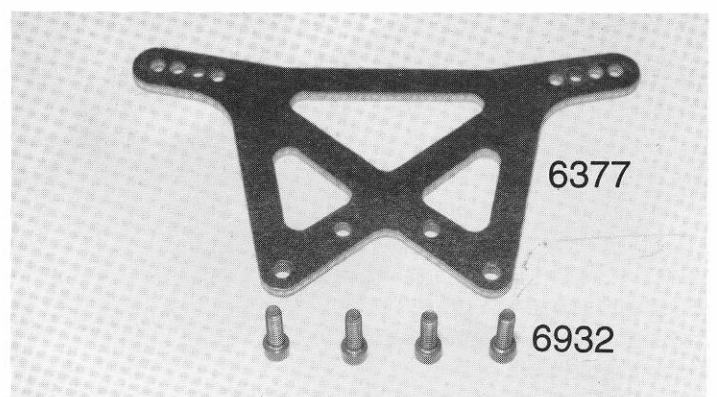
**Fig. 81**

□ **Fig. 82** Your installed bulkhead will look like fig. 82.

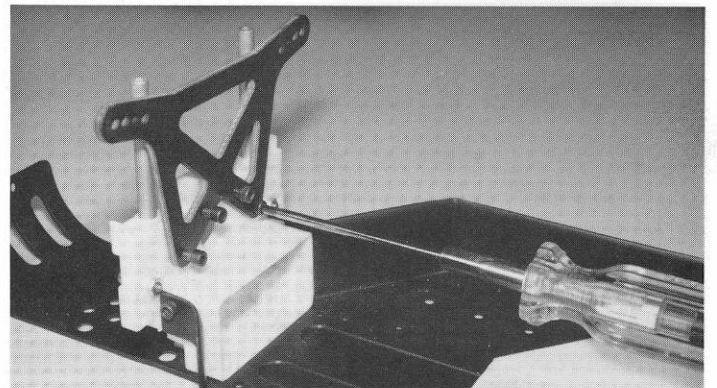


**Fig. 82**

□ **Figs. 83 & 84** In bag #6-4 you will find the #6377 graphite rear shock strut and four #6932 4-40 x 5/16" SHCScrews. Mount the rear shock strut to the front of the rear bulkhead using the four screws, as shown in fig. 84.

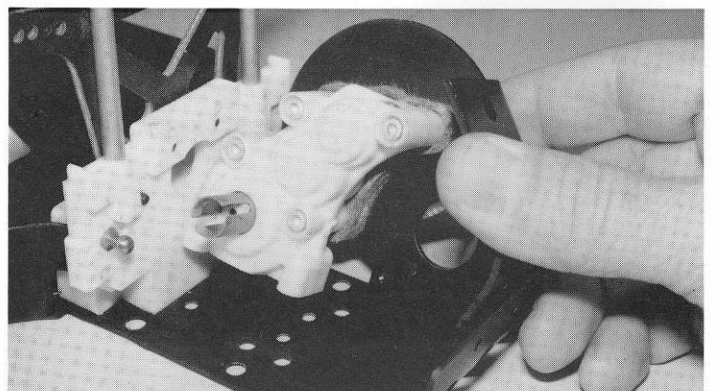


**Fig. 83**



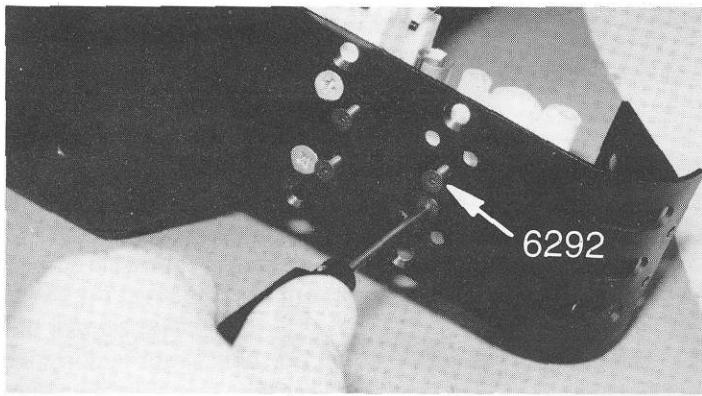
**Fig. 84**

□ **Figs. 85 & 86** Now it is time to mount the Stealth transmission to the aluminum chassis. In bag F of your transmission bag you will find four #6292 4-40 x 3/8" FHSScrews. Place the transmission on top of the chassis as shown in fig. 85, making sure the motor plate is inside the kickup at the end of the chassis. Now turn the transmission and chassis upside down and install the four #6292 screws in the four holes indicated in fig. 86. Do not completely tighten these screws yet.



**Fig. 85**



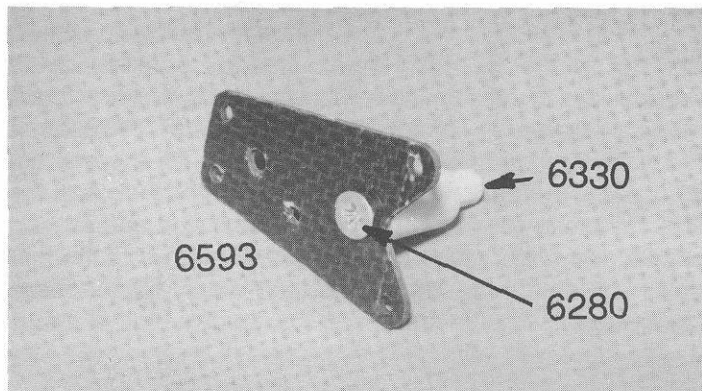


 #6292  
4-40 x 3/8

**Fig. 86**

□ **Figs. 87 & 88** In bag #6-4 you will find the #6593 graphite transmission brace and four #6932 4-40 x 5/16" SHCScrews. In bag #6-5 you will find one #6330 nylon body mount and one #6280 8-32 x 1/2" FHMScrew. Install the #6280 screw through the graphite brace and then thread on the nylon body mount until it is tight against the brace. **Note:** *The brace is not countersunk for the flat head screw, but it does not matter; it will work fine as it is.*

Now place the brace and body mount on top of the bulkhead and transmission. Line up the four holes and thread in the four #6932 screws. Do not completely tighten the screws.

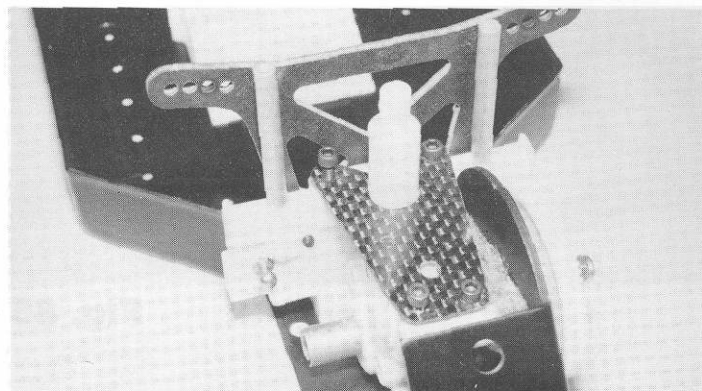



6593


6330

6280

**Fig. 87**



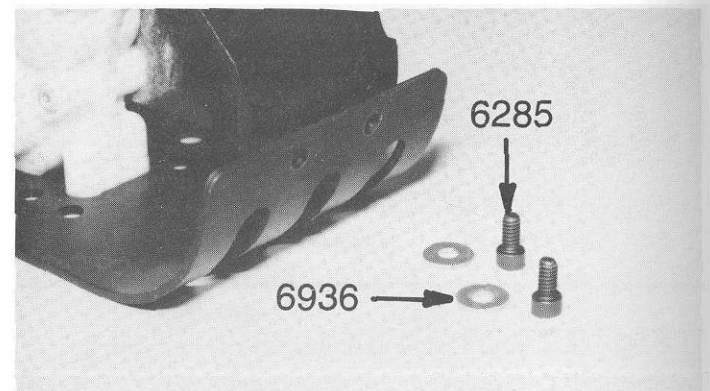
 #6280  
8-32 x 1/2  
aluminum

 #6932  
4-40 x 5/16

**Fig. 88**

□ **Figs. 89 & 90** Before the two motor plate-to-chassis screws are installed we need to tighten some of the other screws now. We will start with the four bulkhead mounting screws from figs. 80-88. **DO NOT** overtighten any screws going into nylon parts.

In bag #6-4 you will find two #6285 4-40 x 1/4" SHCScrews and four #6936 #4 flat washers. This part of the assembly is very critical. Look at the rear chassis and motor plate area as in fig. 90. The motor plate rear mounting holes must match the rear chassis mounting holes **PERFECTLY**. Any misalignment here might change the rear anti squat angle. If the holes do not match up, there are two things you can do. You can carefully bend the rear end of the chassis and the motor plate so they match, or you can place one or two #6936 #4 flat washers between the two surfaces as needed. Either way will work if done properly. **Note:** *This is one of the areas that can give your car more consistent handling like our Team driver's cars, so take your time.* Now go ahead and install the two #6285 SHCScrews and any of the needed #6936 flat washers (see fig. 90).



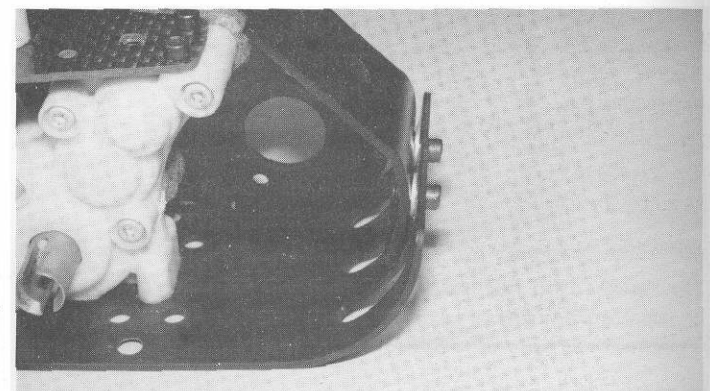
6285

6936

 #6285  
4-40 x 1/4  
steel

 #6936  
#4 flat washer  
aluminum

**Fig. 89**

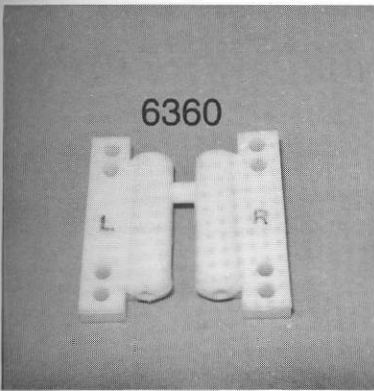


**Fig. 90**

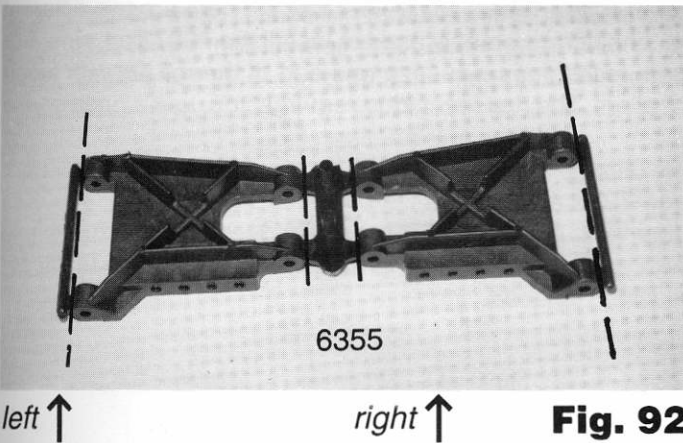
□ **Figs. 91 & 92** Now it is time to open up bag #6-8 and remove the two #6360 nylon rear suspension mounts. Your rear suspension mounts will be connected by a nylon molding runner. Remove both mounts from the runner. On the bottom of the mounts you will find a "R" and "L" molded

into them. Be sure to trim off ALL of the mold runner.

Now remove the two #6355 new black rear suspension arms from the same bag. Trim off every part of the molding runners. Fig. 92 shows the difference between the left hand and right hand rear arms.



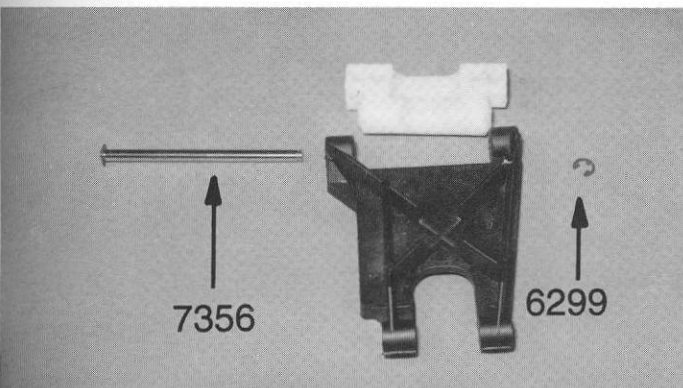
**Fig. 91**



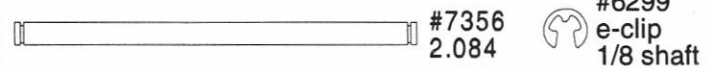
**Fig. 92**

□ **Fig. 93** From bag #6-8 remove two #7356 rear inner hinge pins and four #6299 1/8" E-clips. First check the fit of the hinge pins in the arms. The arms should swing freely on the hinge pins while still tight in the mounts.

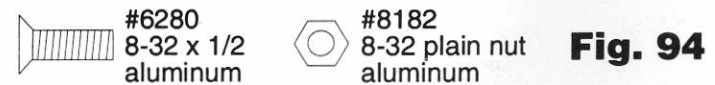
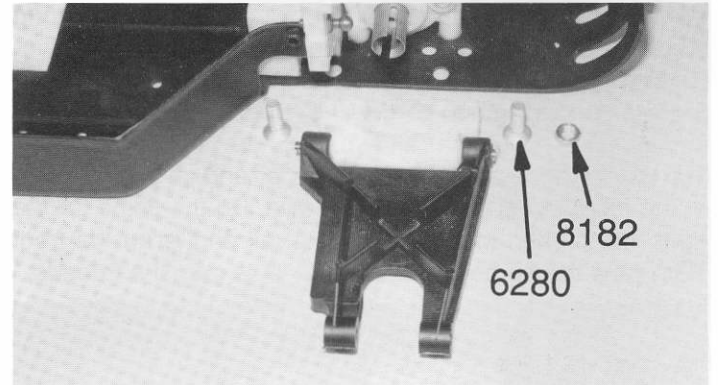
Place the #6360 rear mount with the "L" molded into it between the ears of the #6355 rear arm as shown. Now slide the #7356 hinge pin through one side of the rear arm, through the mount, and then out the other side of the rear arm. Now install an E-clip on each groove of the hinge pin. Now go back to fig. 91 and repeat the steps for assembling the right hand parts.



**Fig. 93**

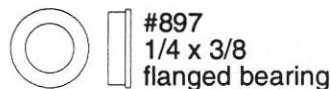
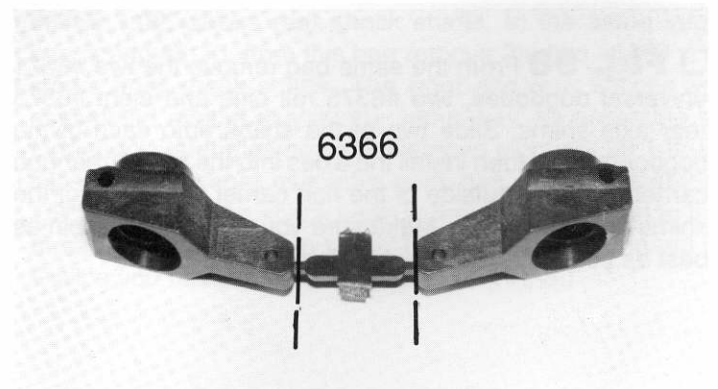


□ **Fig. 94** In bag #6-8 you will find four #6280 8-32 x 1/2" aluminum FHMScrews. Start by mounting the left hand rear suspension assembly onto the chassis. Slide the front edge of the #6360 rear mount underneath the rear bulkhead. This will line up the two rear mounting holes with the two holes in the chassis. Fasten the mount to the chassis using two of the #6280 FHMScrews. On the rear screw thread on the #8182 aluminum plain nut from bag #6-8. Now mount the right side parts the same way.



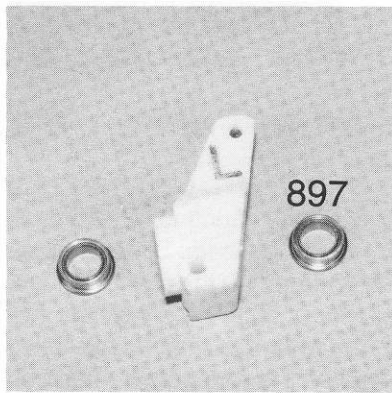
**Fig. 94**

□ **Figs. 95 & 96** Again from bag #6-8 remove the two #6366 rear hub carriers and four #897 1/4" x 3/8" flanged ball bearings. Fig. 95 shows the new black rear hub carriers. This is what will be in your kit, even though the photos show carriers that are white. The hub carriers may be connected by a molding runner; if so, break them off. Now install one of the #897 bearings into each side of the two rear hub carriers.



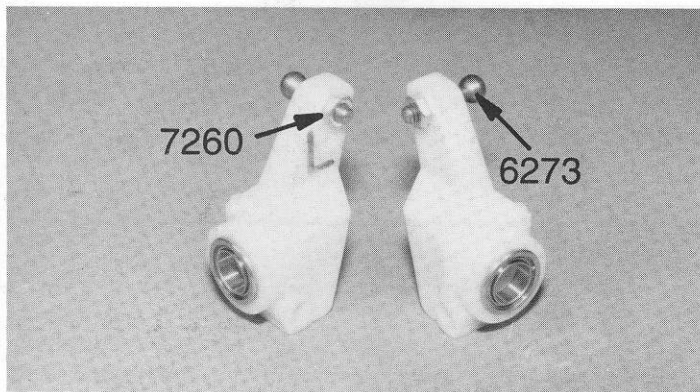
**Fig. 95**





**Fig. 96**

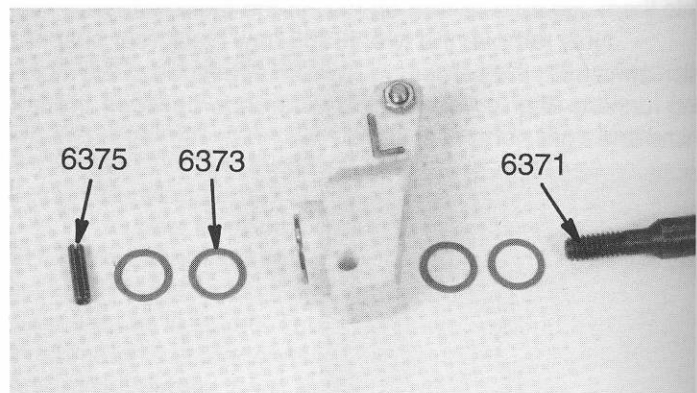
□ **Fig. 97** In bag #6-14 you will find two #6273 long steel ball ends and two #7260 small plain nuts. We are going to install these into the two #6366 rear hub carriers. There is a right and a left hub carrier, the left having an "L" molded into the back side of it as shown, but there is nothing molded into the right side carrier. Install the ball end on the front side of the left hand hub carrier as shown. Do the same for the right hub carrier, making sure the ball end is on the front side. Now thread both of the #7260 nuts onto the threads.



 #6273  
4-40
  #7260  
4-40  
thin plain nut

**Fig. 97**

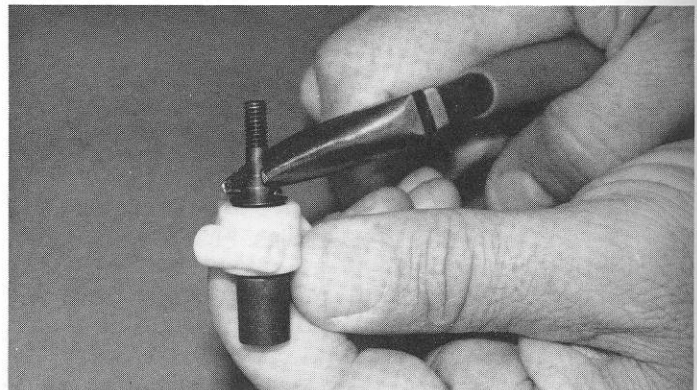
□ **Fig. 98** From the same bag remove the two #6371 universal dogbones, two #6375 roll pins and eight #6373 rear axle shims. Slide two of the shims onto each of the dogbones, and then install the axles into the #6366 rear hub carriers. On the outside of the hub carrier install two of the shims and the roll pin. Make sure you center the roll pin as best as you can; the following photos explain how.



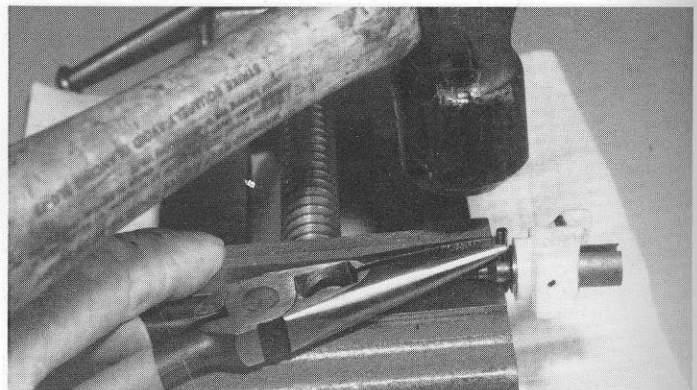
 #6373  
spacer

**Fig. 98**

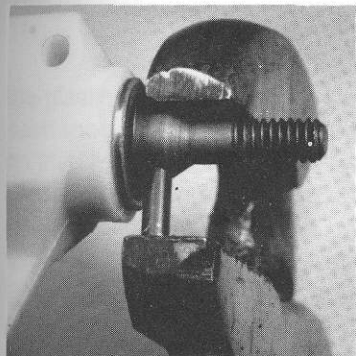
□ **Figs. 99, 100 & 101** There are two different techniques commonly used to install the #6375 roll pins. For both techniques, squeeze one end of the roll pin with a pair of pliers. The first technique requires you use a needlenose pliers (fig. 99) or slip joint pliers (fig. 101) to squeeze the roll pin into the axle. If you are unable to use your pliers you can use a vice and hammer as shown in fig. 100: Set the axle on your vice. Hold the roll pin aligned over the hole in the axle with your pliers. Lightly tap the pin into the axle until the pin is evenly spaced.



**Fig. 99**

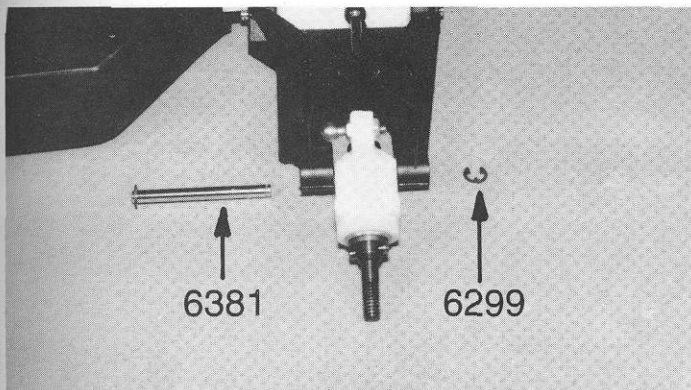


**Fig. 100**



**Fig. 101**

□ **Fig. 102** Remove the two #6381 rear outer hinge pins and four #6299 1/8" E-clips from bag #6-8. Now take the left hand hub carrier assembly and place it between the outer mounting points on the left hand suspension A-arm. Now slide the #6381 hinge pin through one side of the outer arm, through the hub carrier and out the other side of the arm. Install a #6299 E-clip onto each side of the hinge pin.

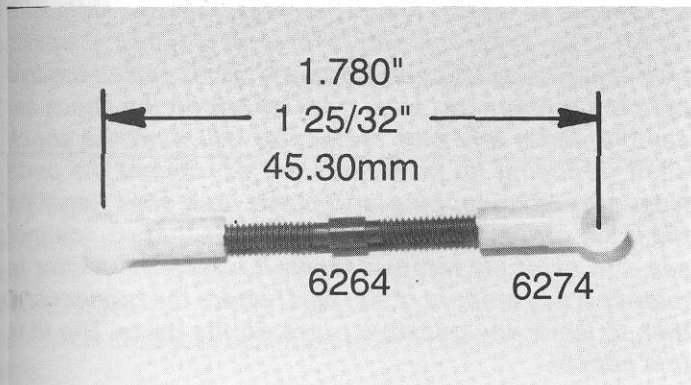


□ **Fig. 102**

#6299 e-clip 1/8 shaft

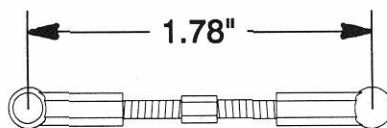
#6381

□ **Fig. 103** Now you will want to find the two #6264 1.375" long turnbuckles in bag #6-8. You will also need four #6274 plastic ball end caps from bag #6-14. Thread the plastic ball end caps onto the two turnbuckles to 1.78" (1 25/32" or 45.3mm) from the center of the ball cup hole to the center of the other ball cup hole. You will see that on these turnbuckles the plastic ball end caps are facing opposite directions (one faces forward, the other faces to the rear).

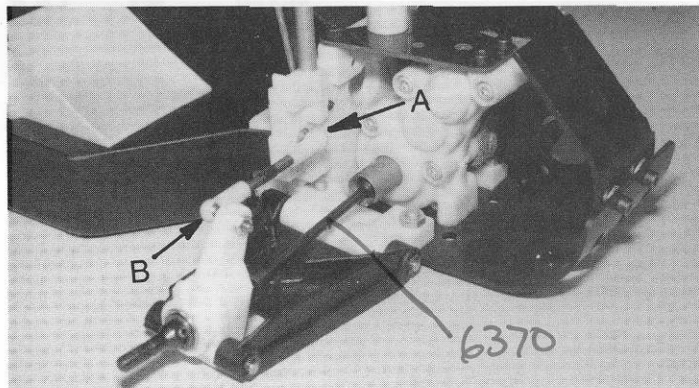


□ **Fig. 103**

#6274



□ **Fig. 104** Starting with the left hand suspension and turnbuckle, snap one end of the turnbuckle onto ball end location (A) on the rear bulkhead and the other end onto ball end location (B) on the rear hub carrier. When installed, your turnbuckle should look like fig. 104. Now go ahead and repeat the step for the right side turnbuckle.



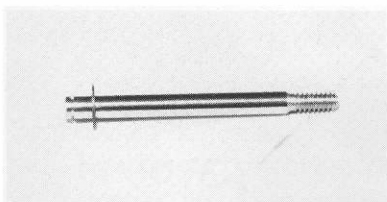
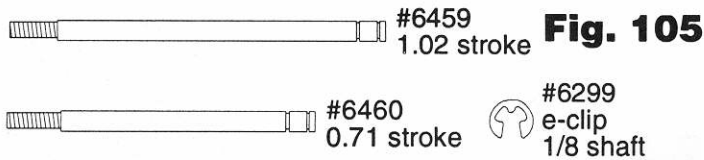
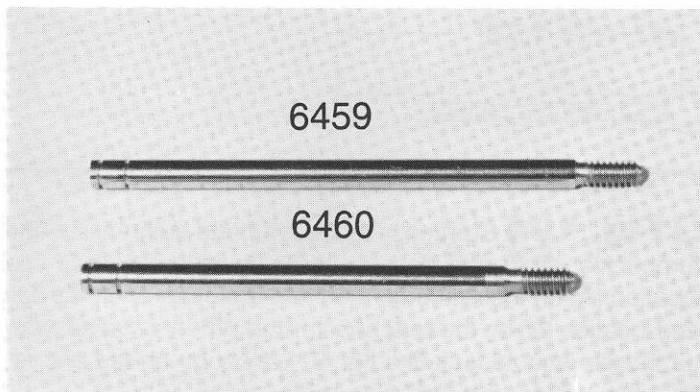
**Fig. 104**

## SHOCK ASSEMBLY

We have made several major improvements to our new internal assembly shocks with the addition of new molded Teflon shock pistons and internal shock seal assembly parts. **PLEASE FOLLOW THE NEW ASSEMBLY INSTRUCTIONS CAREFULLY!**

□ **Figs. 105 & 106** In the master bag you will find a large bag containing all the shock assembly parts. Inside this bag is bag #6-9; from this bag remove the two #6459 1.02" stroke rear shock shafts. In the same large bag is bag #6-10; from this bag remove the two #6460 .71" stroke front shock shafts. The front and rear shocks are assembled almost exactly the same way, so assemble all four shocks at the same time. Remove eight #6299 1/8" E-clips from the shock assembly parts bag. Install one #6299 1/8" E-clip on each shock shaft in the groove closest to the threaded end, as shown in fig. 105. (If you have run out of E-clips you have extras in bags #6-1 or #6-8.)

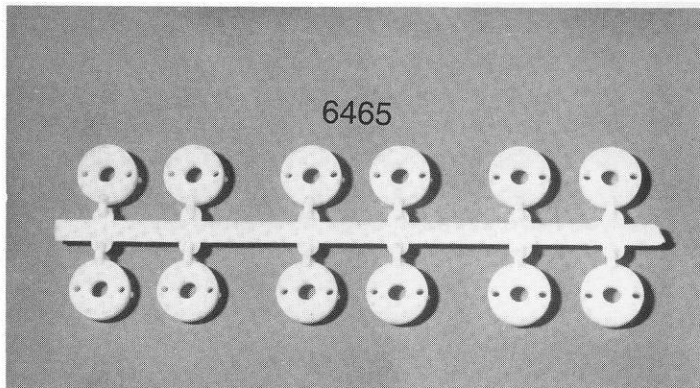




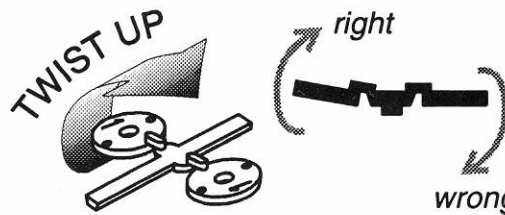
**Fig. 106**

□ **Figs. 107 & 108** In a separate bag inside the large shock bag you will find the #6465 new Teflon shock piston set. You will find four each of #1, #2, and #3 shock pistons on this piston parts tree. The #1 piston is the lightest damping and the #3 piston is the heaviest damping.

The new pistons are molded to help eliminate the possibility of burrs on the piston edge, burrs which would interfere with smooth shock action within the shock body. To properly remove the shock pistons from the tree, twist the piston up as shown in fig. 107. Twisting down will leave a rough edge on the piston, reducing shock performance. For the buggy you will need to remove the four #1 pistons from the parts tree. If there are any burrs remaining on the pistons **carefully** remove them with a sharp hobby or X-acto® knife.



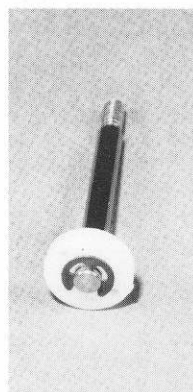
**Fig. 107**



(NOT ACTUAL SIZE)

**Fig. 108**

□ **Fig. 109** Install the four shock pistons onto the #6459 rear shock shafts and #6460 front shock shafts. Secure each piston to the shaft with a #6299 1/8" E-clip. Fig. 109 shows one of your shock shafts with piston installed. **Racers Tip:** It does not matter which way you install the pistons, but we recommend having the molded number up so that it will be easier to remember what piston you are using when you service your shocks.



**Fig. 109**

#6299  
e-clip  
1/8 shaft

□ **Figs. 110, 111 & 112** In another plastic bag you will find the new #6440 molded shock assembly parts and #5407 red O-rings and #6469 black O-rings. **Note:** Part number #6440 is a complete replacement set of O-rings and plastic assembly parts to rebuild four shocks. This molded parts tree contains only enough plastic parts to assemble four shocks, so don't lose any. The names of the parts are noted in fig. 110.

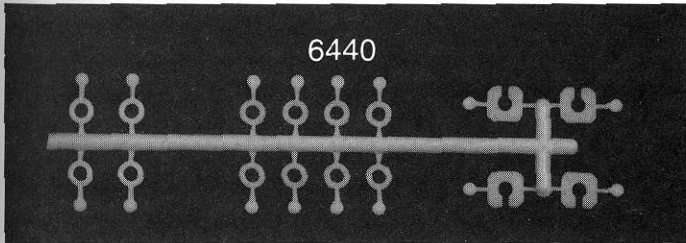
**WARNING!** Because of the precision tolerances of these new parts, correctly removing the parts from the parts tree is **CRITICAL!** Using an X-acto® knife with a very sharp blade, carefully trim each part from the parts tree. It is **EXTREMELY** important that no part of the two molding runners (on each part) be left on the shock assembly parts; any part remaining will bind the shock shaft (reducing its performance), or prevent the parts from properly snapping into place. Use your finger on the edge of the parts to feel for burrs that you cannot see and carefully remove them. It is actually better to remove a tiny amount of the part (where the runners are) than to leave any possible burrs on the parts. The fit is this critical.

In the large shock main bag you will find a small plastic bag containing the #6429 plastic shock assembly tool.

This round plastic tool with the angle cut tip will look like fig. 111.

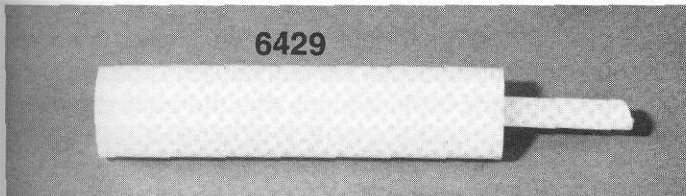
Remove the #5407 red O-rings from the same bag the plastic shock parts came out of. To correctly assemble each shock it is necessary to install each of the internal parts on the shock assembly tool in the correct order. Stand the assembly tool on end with the small tip up. Install the parts on the tool in the following order: (1) plastic split locking washer, (2) then one small plastic washer, (3) red O-ring, (4) large plastic spacer, (5) red O-ring, (6) and second small plastic washer. You can compare this sequence with layout in fig. 112. Fig. 113 shows a cutaway drawing of the shock body with the internal seal parts installed.

You can skip figs. 113 & 114 until you need to dismantle the shocks.

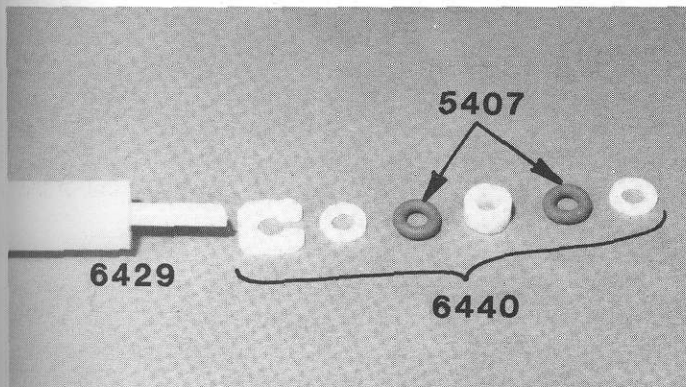


Above left: four large nylon spacers  
Center: eight small nylon washers  
Right: four split washers

**Fig. 110**



**Fig. 111**

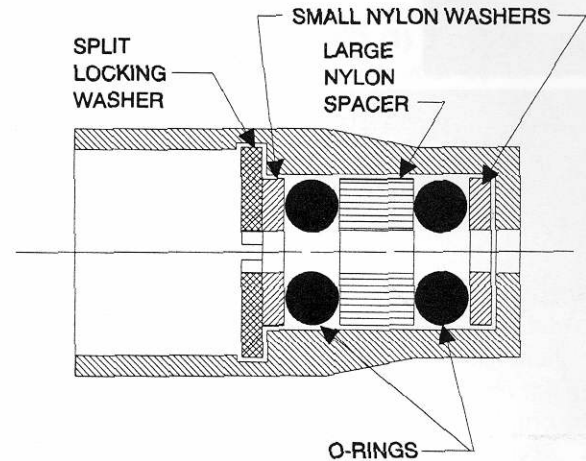


**Fig. 112**

**Figs. 113 & 114 HOW TO DISMANTLE THE SHOCK SEAL PARTS** fig. 113 shows a cutaway of the bottom portion of the shock showing how all of the parts fit into the shock seal cavity. Fig. 114 is the same cutaway drawing, but depicts the shock assembly tool removing the shock seal parts.

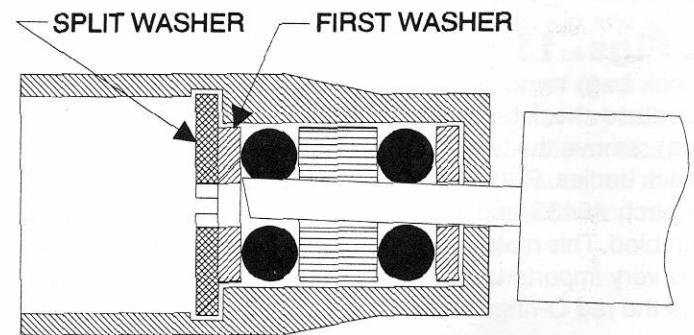
In order to dismantle the shock seal parts you must (1) remove the shock cap, (2) drain the shock oil, (3) and

remove the shock shaft with piston. (4) Insert the small angled tip of the shock tool into the bottom of the shock. (5) First slide the tool all the way in until the tool bottoms out against the shock body. (6) Now angle the tool slightly, and slowly slide the tool down until the tip slides over underneath the split washer and first small nylon washer. (7) Now place the pointed tip of the tool under one side of the split locking washer (fig. 114) and push firmly up until the split washer snaps out of its groove. (8) Then pull the tip of the tool down and use it to push the rest of the internal parts up and out of the cavity.



(NOT ACTUAL SIZE)

**Fig. 113**



(NOT ACTUAL SIZE)

**Fig. 114**

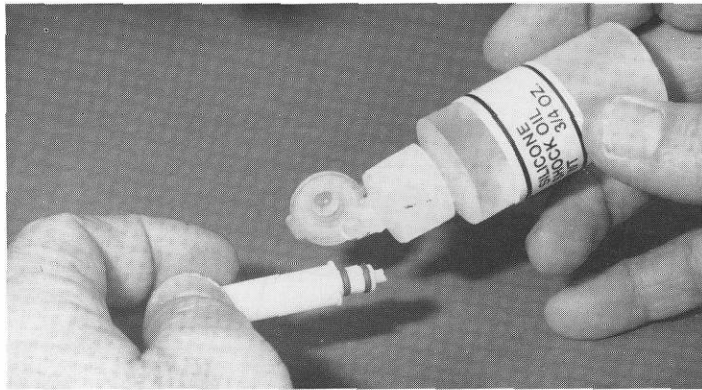
Position shock assembly tool as shown and push the split washer out of its groove.

**Figs. 115 & 116** Open bag #6-11 and remove the container of 30 weight silicone shock oil. This is the recommended starting weight oil for the new shock pistons. (When you run out of silicone oil, its replacement number is #5422.) Apply a liberal amount of silicone oil to the internal seal parts on the assembly tool as shown.



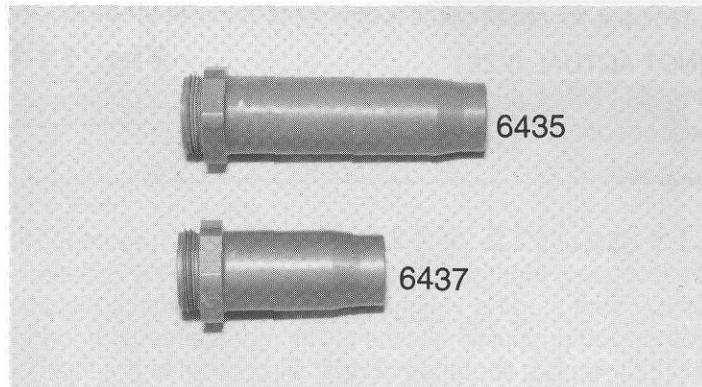


**Fig. 115**



**Fig. 116**

□ **Figs. 117 & 118** From bag #6-9 (in the main shock bag) remove the two #6435 1.32" stroke rear hard anodized shock bodies. From bag #6-10 (in the main shock bag) remove the two #6437 .71" stroke front hard anodized shock bodies. Put a few drops of silicone oil into the bottom of each #6435 and #6437 shock body as it is being assembled. This makes installation of the internal parts easier. It is very important that we do not accidentally cut or damage the red O-rings as they are being installed.

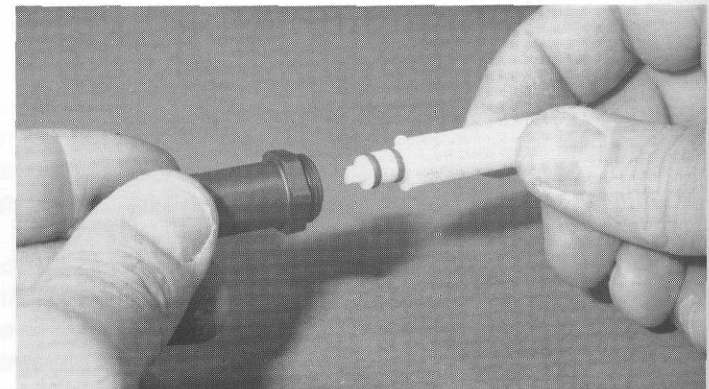


**Fig. 117**



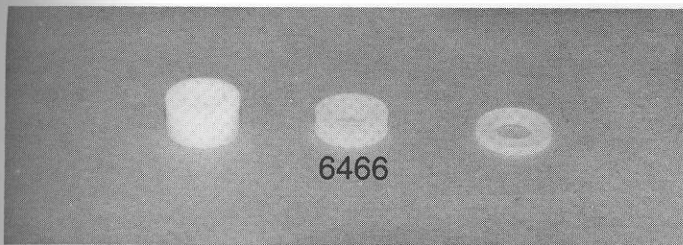
**Fig. 118**

□ **Fig. 119** (1) Take one of the shock bodies and the shock tool, with the internal parts on it, and slowly insert the tool into the shock body until it bottoms out. If everything goes in smoothly, the tip of the shock tool will be even with or just slightly out of the bottom of the shock body. If it isn't, you may need to rotate the shock body to help it seat the parts the rest of the way into the shock cavity. (2) Now stand the shock tool on your workbench, with the shock body on top, and firmly push down on the shock body until you hear and feel the split washer snap into its groove. You may have to push hard before it will go in. (3) When properly installed, the end of the shock tool should be sticking out the bottom of the shock about 1/8". (4) Once the parts have been properly snapped into place, pull the tool out. (5) Look inside the shock body for any obvious signs that the parts did not go together correctly. **MAKE SURE THE WASHER IS FULLY SEATED IN ITS GROOVE.** If the parts are not seated correctly, the shock will leak or even come apart internally. (6) Go ahead and repeat the same steps for the other three shock bodies.

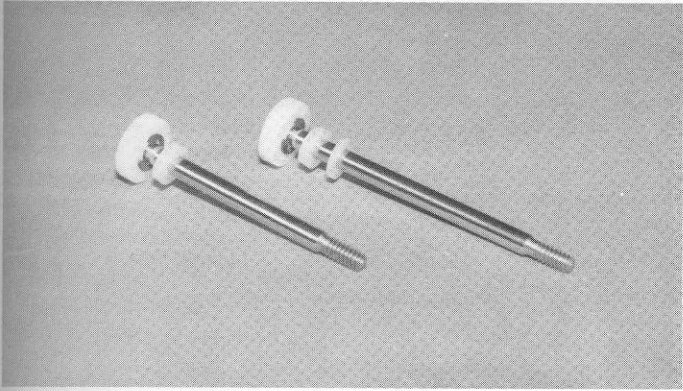


**Fig. 119**

□ **Figs. 120 & 121** In bag #6-9 you will find a small bag containing the #6466 plastic downstop spacers (travel limiters) of three thicknesses: .125", .062" & .031". (1) Install the travel limiters on the front and rear shock shafts. Install one .062" spacer and one .031" spacer on each rear shaft. (2) Install one .062" spacer on each front shaft.

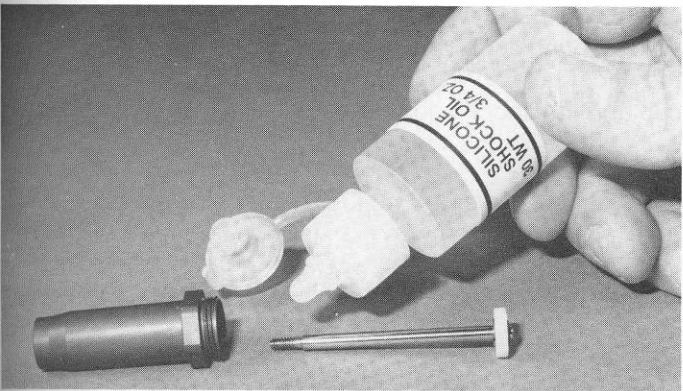


**Fig. 120**



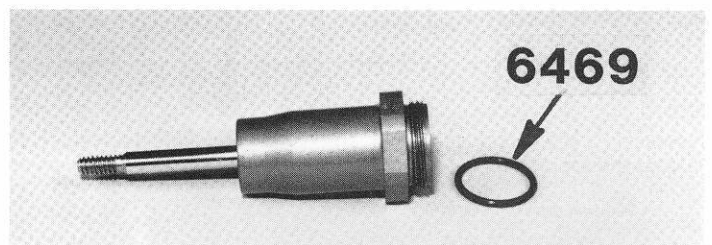
**Fig. 121**

□ **Fig. 122** We will now install the shock shafts with pistons and spacers. (3) Place a couple of drops of oil on each shock shaft, and (4) slowly insert the shaft and piston into the shock body. Be sure to install the long shock shafts in the long shock bodies and the short shock shafts in the short shock bodies. (5) Pull the shaft down until the piston seats against the bottom of the shock body. Be careful inserting the shaft, for we do not want to damage the red O-rings and cause the shock to leak.



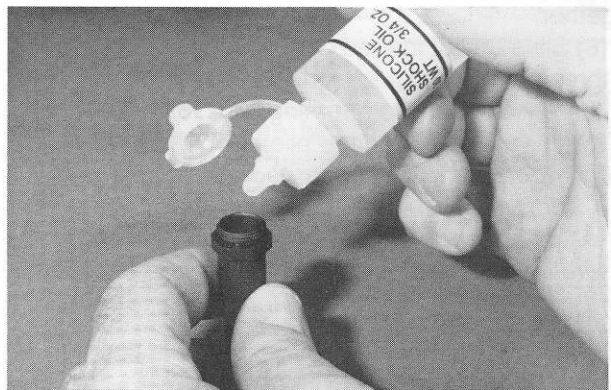
**Fig. 122**

□ **Fig. 123** Locate the four #6469 black O-rings in the shock accessory bag (inside the main shock bag). Install one black O-ring over the threads of the shock body, and seat it flush in the pocket at the bottom of the threads.



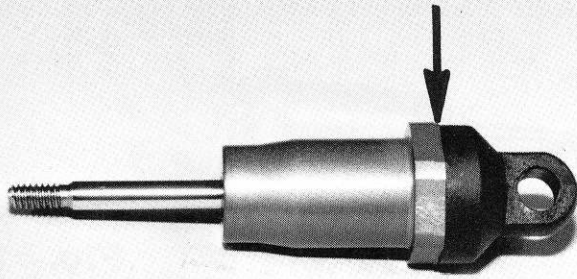
**Fig. 123**

□ **Figs. 124 & 125** (1) Now we are going to fill each shock with shock oil. Take your container of silicone 30 weight shock oil and fill a rear shock with oil until it is within 1/16" of the top of the shock body, and fill your front ones all the way to the top. (2) Now move the shock shaft up and down, slowly, several times, to make sure that there are no air bubbles trapped under the piston. (3) If there were air bubbles, refill the shock until it is within 1/16" of the top. (4) Now push the shock shaft up until the piston is close to the top of the shock body, but still completely covered by the oil. (5) Now thread your #6439 black aluminum shock cap (they are in bags #6-9 and #6-10) onto the shock body. There should be no gap between the cap and the hex portion of the shock body (see arrow in fig. 125). The O-ring will actually be doing the sealing, so as soon as the cap comes in contact with the body, just turn it a little bit further to seat it. (6) Now work the shock shaft up and down several times and then press the shaft all the way in and let go of the shaft. The shaft should come back out of the shock about 1/4" on its own. This is the correct amount of rebound. But you should be able to compress it all the way back in easily. (7) If it comes out more than 1/4", the piston was too far down in the shock body at step (4). If it does not come out enough, then the piston was too close to the top of the shock body. (8) Do the other three shocks.



**Fig. 124**



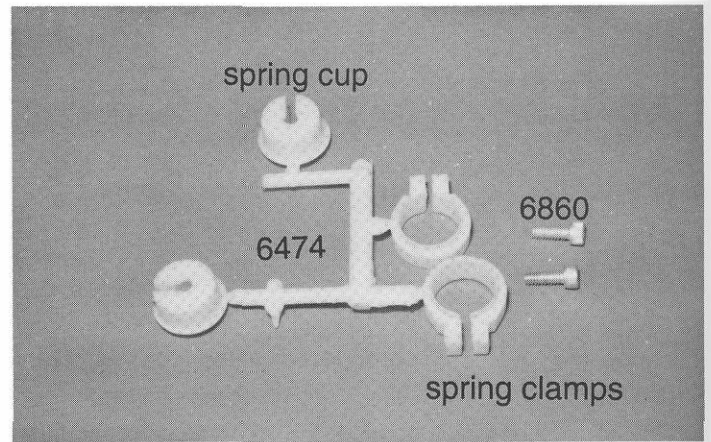


**Fig. 125**

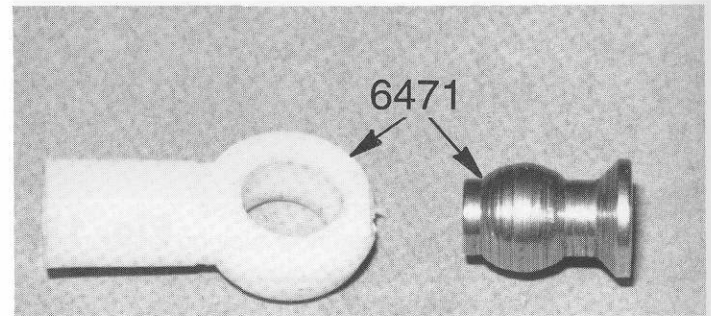
□ **Fig. 126 & 127** (1) From bag #6-11 remove the two #6474 spring clamps and cups parts trees and four #6860 4-40 x 3/8" aluminum SHCScrews. (2) Remove the shock spring clamp and cup parts from the parts trees. (3) Each tree has both a left and a right spring clamp on it. Slide the nylon clamp onto each shock with the thin flange edge on the shaft side. (4) Each spring clamp has one hole that is slightly larger than the other. Install the #6860 aluminum screw through the larger hole and then thread it into the smaller hole. (5) Now slide the clamp to the top of the shock body and tighten it just enough to keep the clamp from moving.

(6) From bags #6-9 and #6-10 and remove the #6471 nylon shock rod ends and .230 shock steel pivot ball ends, two from each bag. See fig. 127. From the shock assembly parts bag (inside the main shock bag) remove the remaining two #5407 red O-rings. (7) Now take one of the #6471 plastic shock rod ends and push it onto the steel shock pivot ball. The easiest way to do this is to place the metal ball end on a table with the flat side against the table. Set the plastic rod end over the ball and push it into place with your 1/4" nut driver. You can also use pliers to squeeze the parts together.

(8) Slide one of the red O-rings onto each rear shaft then (9) thread the nylon shock rod end onto the shock shaft. To keep the shock shaft from turning, you will have to hold the shaft with your needle nose pliers. **WARNING! Using only the smooth part of your needle nose pliers, grab only the shaft, not the threads, and as close to the threads as possible.** This is very important, for we do not want to scratch the shaft where it will ride in the O-rings, for this could damage them, causing the shock to leak. Assemble the other three shocks.



**Fig. 126**



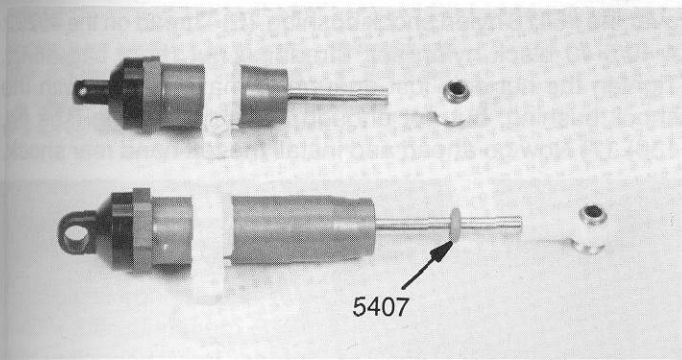
**Fig. 127**

□ **Figs. 128 & 129** (1) From bag #6-11 remove the two long #6480 2.75" rear green springs. (2) Install one spring onto each of the long rear shocks. (3) Leaving the shaft extended, slide the red O-ring to the top of the shaft (4) and then slide on the spring and seat it against the spring clamp clamp. (5) Compress the spring and slide one of the #6474 spring cups onto the shaft and over the #6471 shock rod end. Make sure the red O-rings are between the spring cup and the shock body.

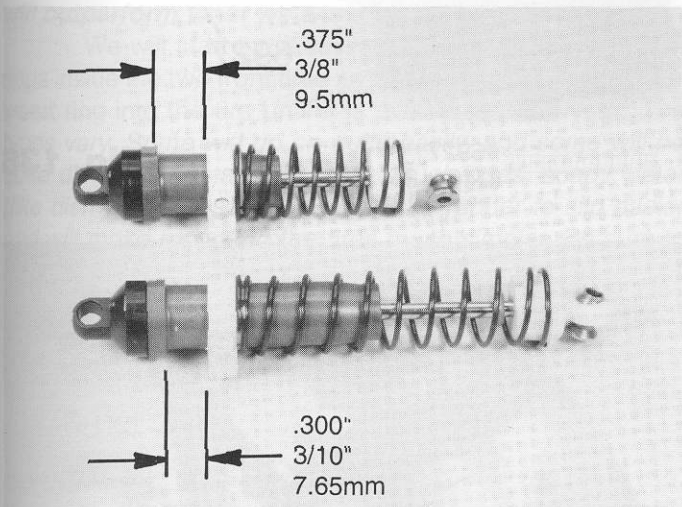
(6) For the rear shocks, adjust your spring clamps so that there is a .300" (3/10" or 7.65mm) gap between the hex portion of the shock body and the top of the shock clamp (see fig. 129). (7) Tighten the clamp enough so it cannot be moved, but not so tight as to strip out the threads.

(8) Remove the two remaining #8232 1.4" front black springs from bag #6-11. Repeat the steps used in fig. 128, but using the #8232 springs, and adjust your spring clamps with a spacing of 3/8" (.375" or 9.5mm) as shown in fig. 129.



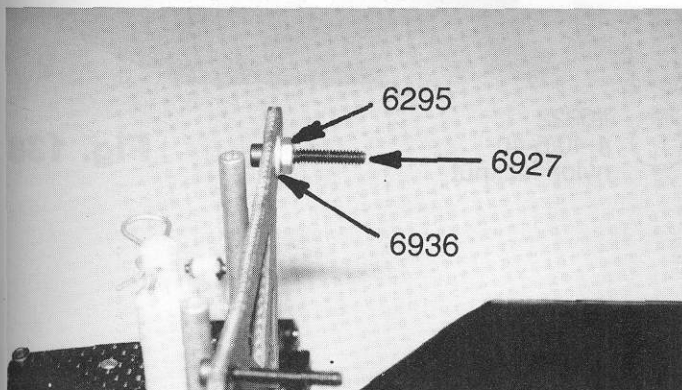


**Fig. 128**






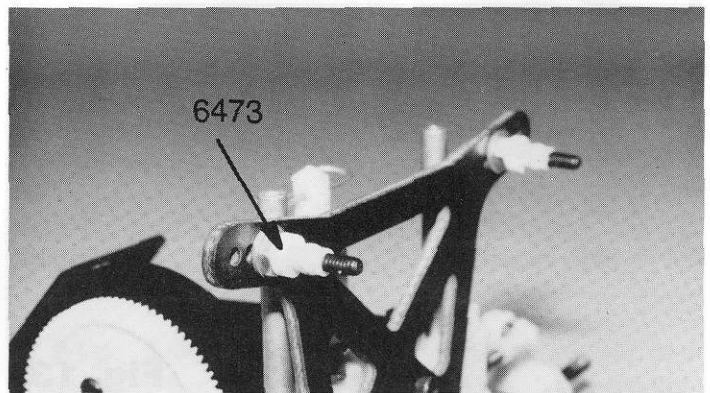
**Fig. 129**

□ **Figs. 130 & 131** (1) From bag #6-9 remove two #6927 4-40 x 3/4" SHCScrews, two #6936 #4 aluminum flat washers, and two #6295 4-40 plain nuts. (2) There are now four holes in the top of the rear shock strut. Screw the 4-40 x 3/4" SHCScrews into the second hole from the inside of the shock strut, from the back side as shown. (3) Now install one of the #6936 #4 flat washers on the front, and then (4) thread on the #6295 4-40 plain nut. (5) Tighten the screws and nuts. (6) Next install one of the #6473 nylon shock bushings, from bag #6-9, onto each screw (see fig. 131), the flange of the bushing against the 4-40 plain nut.



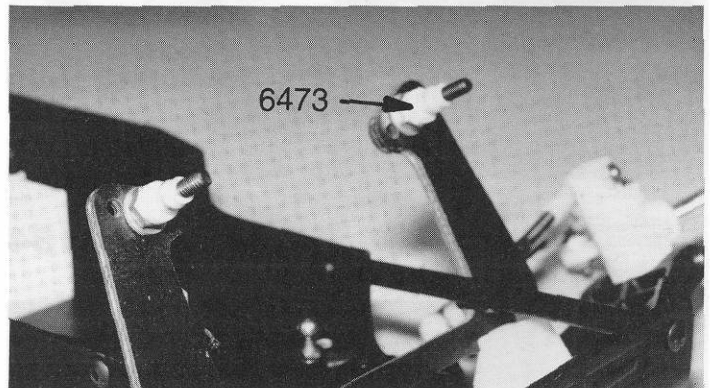
**Fig. 130**

-  #6936 #4 flat washer aluminum
-  #6295 4-40 nut plain
-  #6927 4-40 x 3/4



**Fig. 131**

□ **Fig. 132** Take the two #6473 nylon shock bushings from bag #6-10 and install them onto the front shock mounting screws, the flange of the bushing toward the nut.



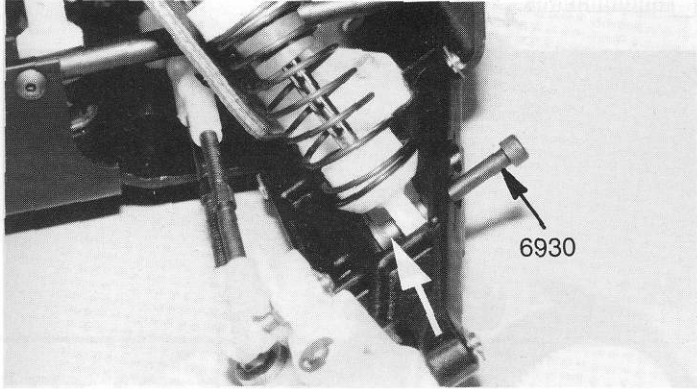
**Fig. 132**

□ **Figs. 133, 134 & 135** (1) Go back to bag #6-1 and take out the two #6930 4-40 x 3/4" Special SHCScrews that have threads only on the end. (2) Take one of the front shocks and slide the shock pivot ball end into the front suspension arm mounting slot, as shown in fig. 133, into the outside hole of two mounting holes. (This photo shows installing the passenger side shock.) The flange side of the steel pivot ball should be toward the rear of the A-arm. (3) Now install one of the #6930 Special screws through the front of the A-arm, the steel pivot ball (see arrow in fig. 133) and thread it into the A-arm. Be careful not to overtighten the screw, or the shock could bind. Most drivers prefer to install their shocks with the spring clamp adjusting screws on the inside, facing forward, to make adjustment easier.

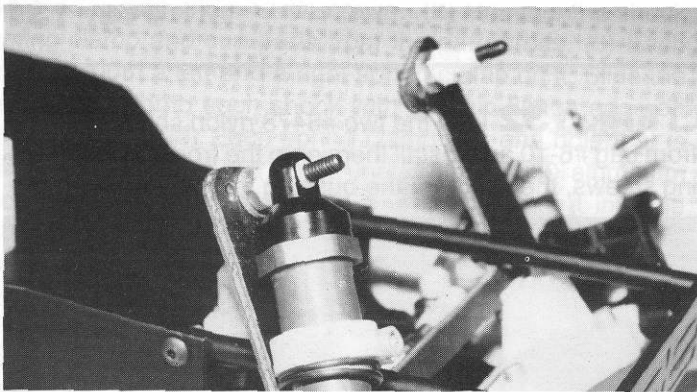
(4) Slide the shock cap eyelet onto the nylon shock bushing (fig. 134) and then (5) take one of the #6222 4-40/5-40 black self threading nylon locknuts (from bag #6-10) and thread it onto the shock screw (see fig. 135). Thread the nut



on until it just touches the bushing. Again, do not overtighten, for it could bind the shock and prevent it from working correctly. (6) Now go ahead and repeat these steps for the driver's side shock.

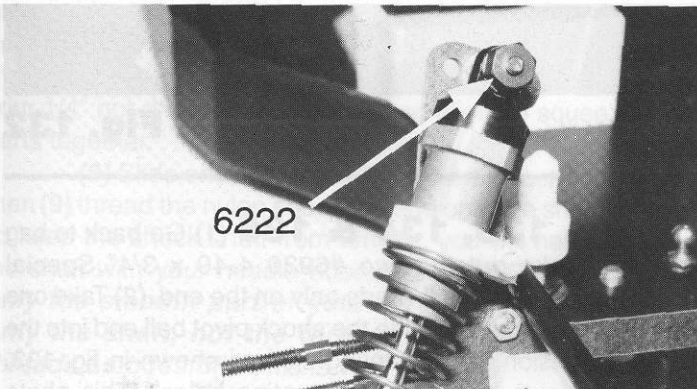


**Fig. 133**



#6930  
4-40 x 3/4  
special

**Fig. 134**

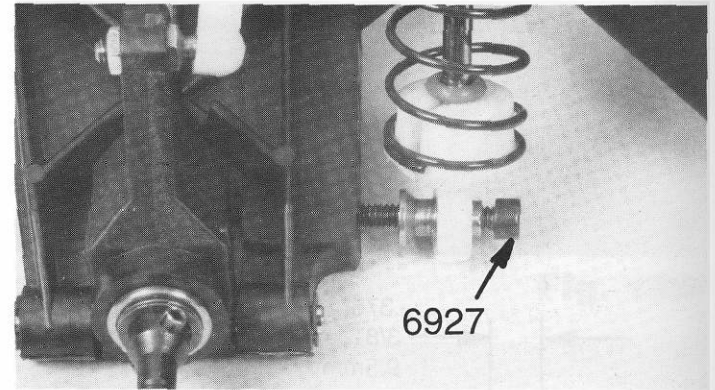


#6222  
4-40/5-40  
nylon locknut

**Fig. 135**

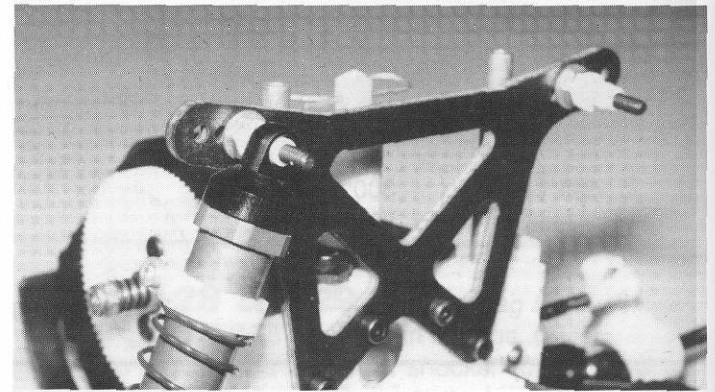
**Fig. 136, 137 & 138** (1) From bag #6-9 take two #6927 4-40 x 3/4" SHCScrews. (2) Install the screw through the steel shock pivot ball on the bottom of the right hand rear shock, screwing it into the outside mounting hole on the rear A-arm as shown in fig. 136. (3) Make sure that the screw goes through the small end of the pivot ball and that the flat side will mount against the rear A-arm as shown.

(5) Now install the upper end of the right rear shock over the #6473 nylon shock bushing. (6) Thread on the #6222 4-40/5-40 black nylon self threading nut (from bag #6-9). Tighten the nut only just enough to make contact with the shock bushing, but not enough to cause binding (see fig. 136). (7) Now go ahead and install the left hand rear shock.

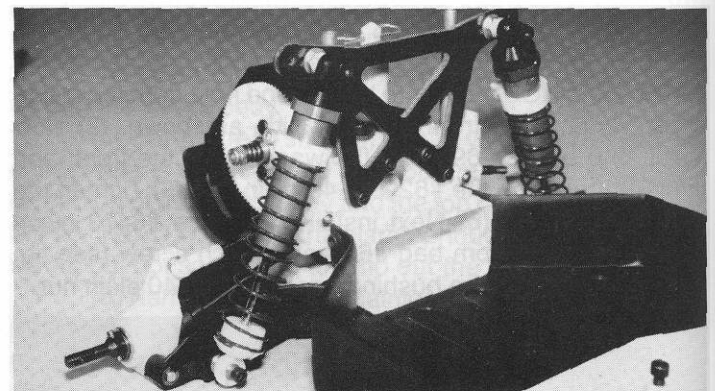


#6927  
4-40 x 3/4

**Fig. 136**



**Fig. 137**



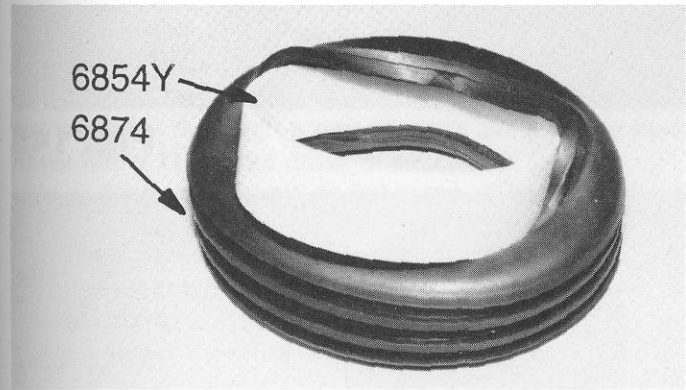
#6222  
4-40/5-40  
nylon locknut

**Fig. 138**

# WHEEL AND TIRE ASSEMBLY

□ **Fig. 139** In the kit box you will find the front tire and wheel bag which contains two Associated #6874 (Proline XTR #8015) flat four-ribbed front tires, the #6854Y yellow three piece front wheels, two small bags containing six #6860 4-40 x 3/8" aluminum SHCScrews and four #6906 3/8" x 3/16" unflanged front wheel bearings. **Note: The tires in your kit may be different from those in the photos, for we are constantly testing tires to find a new combination which will outperform what we were using before.**

We will start by installing the #6854Y plastic insert rings inside the two front tires as shown in fig. 139. Work the insert ring into the tire until it is evenly seated. **Note: Tire types vary. Some will go on quite easily, and some will be quite difficult to install. For these tough ones, soapy water (like dish washing soap) will help the rubber to slip easier and will make mounting the tires much simpler. Be sure to rinse off the soap and dry the tires thoroughly.**

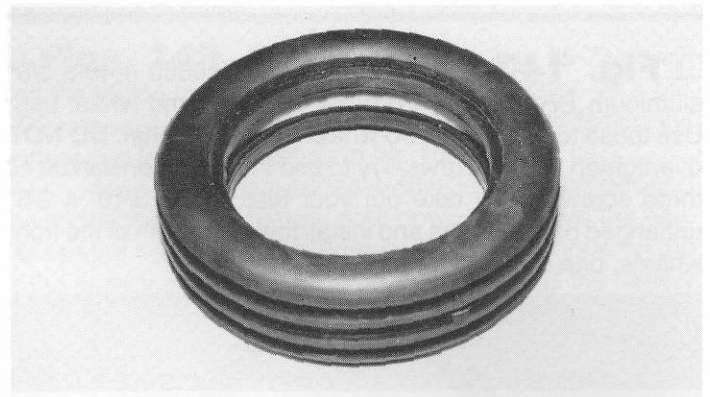


**Fig. 139**

#6860  
4-40 x 3/8  
aluminum

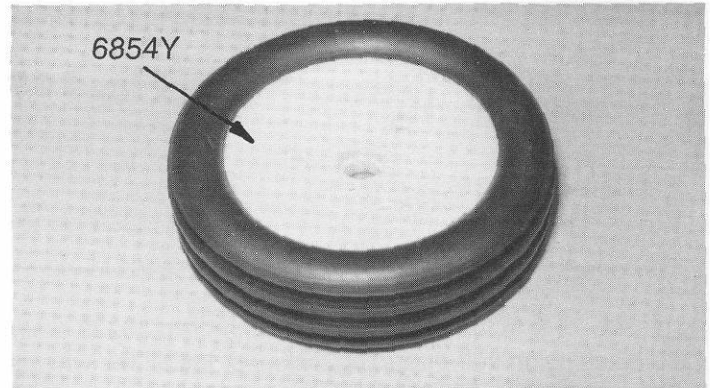
#6906  
3/8 x 3/16  
unflanged bearing

□ **Fig. 140** This photo shows the #6854Y front wheel ring already installed. Double check to make sure the ring is perfectly centered.



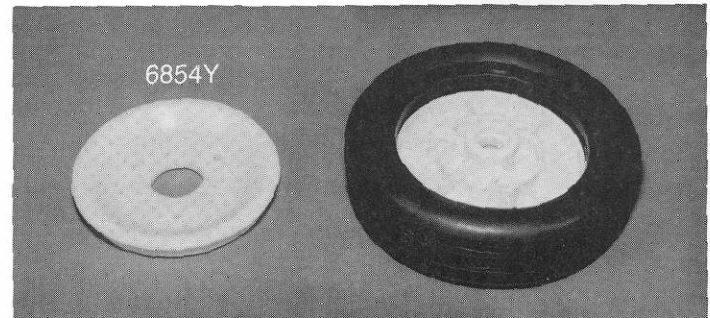
**Fig. 140**

□ **Fig. 141** Take the outer half of the #6854Y front wheel (which has a small center hole) and fit it into the front tire. Make sure it is seated all the way around, and centered evenly. Do the second tire and wheel.



**Fig. 141**

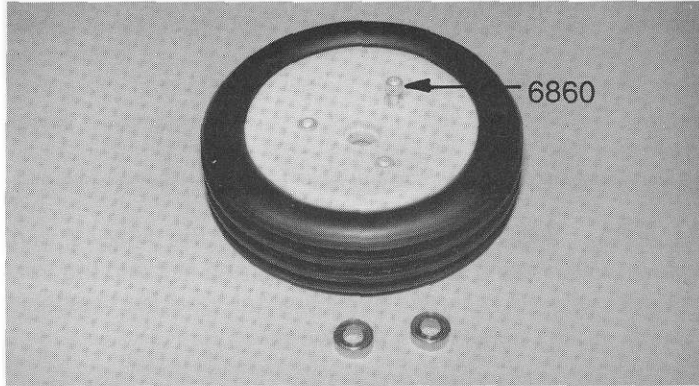
□ **Fig. 142** Turn the wheel over and install the inside half of the #6854Y front wheel (which has the larger center hole). Make sure the screw holes on both wheel halves line up before you insert the back half of the wheel. Finish the second tire and wheel.




**Fig. 142**



❑ **Fig. 143** Remove three of the #6860 4-40 x 3/8" aluminum SHCScrews from the front tire and wheel bag. Use these to screw the two wheel halves together. **DO NOT** overtighten these screws. Try to use the same tension on all three screws. Now take out your four #6906 3/16" x 3/8" unflanged ball bearings and install them into both of the front wheels, one on each side.

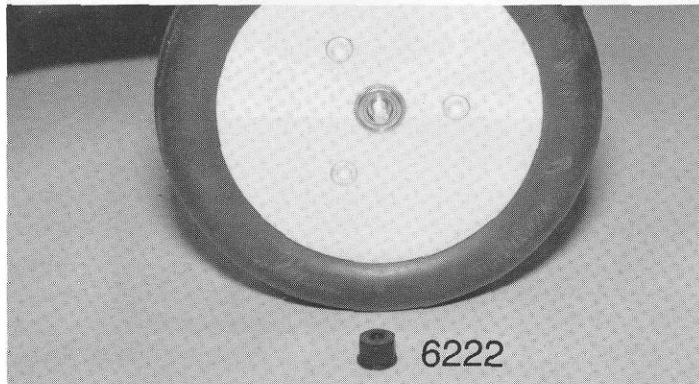



 #6906  
3/8 x 3/16  
unflanged bearing

 #6860  
4-40 x 3/8  
aluminum

**Fig. 143**

❑ **Fig. 144** In bag #6-1 you will find two #6222 4-40/5-40 black nylon self-threading locknuts. Install the wheels and tires onto the #6220 aluminum front axles so that the heads of the Allen screws are facing the outside. Now thread on the #6222 locknuts. Tighten the nuts to take up the end play on the axle, but not so tight that the tires and wheels will not spin freely. If the tires and wheels do not spin true, you will need to remove them and remount the tires.

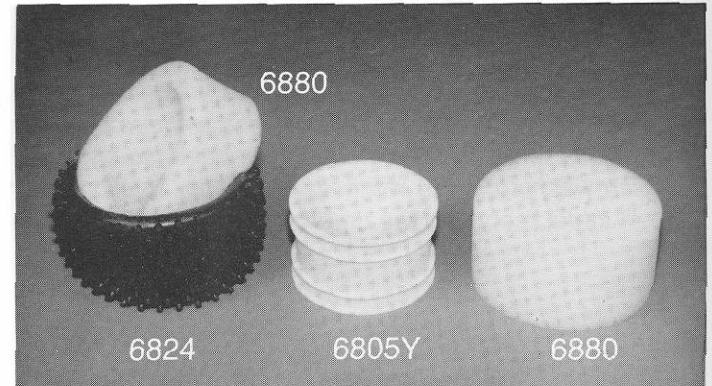


 #6222  
4-40/5-40  
nylon locknut

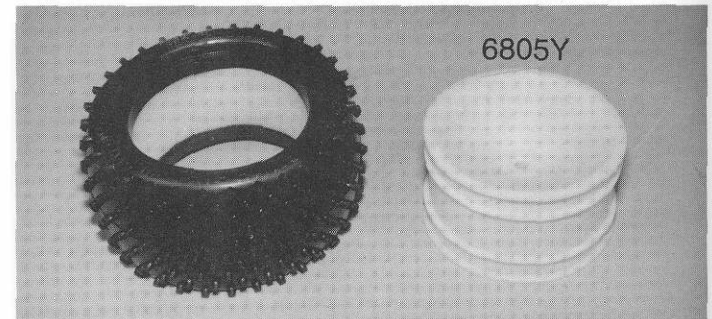
**Fig. 144**

❑ **Figs. 145 & 146** Now go back to the kit box and remove the rear tire bag, which contains two Associated #6824 (Proline XTR #8086) flat stubby rear tires, two #6805Y Yellow 2.175" one piece rear wheels and two #6880 light grey (or blue) foam tire inserts. Remove the #6824 tires and the #6880 foam inserts. Pull the center out of the foam inserts and discard it. Push the foam inserts into the rear tires and center the foam in each tire. Your tire with foam inserts should look like fig. 146.

Now take out your #6805Y rear wheels and mount the rear tires and foam inserts onto them. Check to make sure that the tires are centered on the wheels and that the foam inserts are still centered inside the tires.

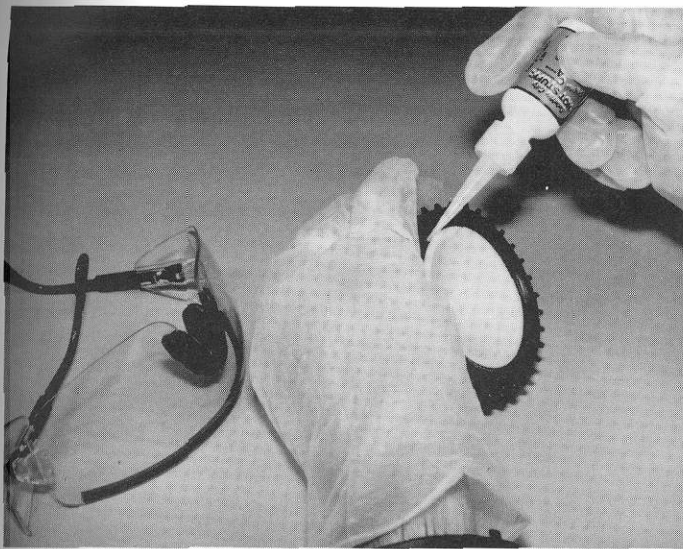


**Fig. 145**



**Fig. 146**

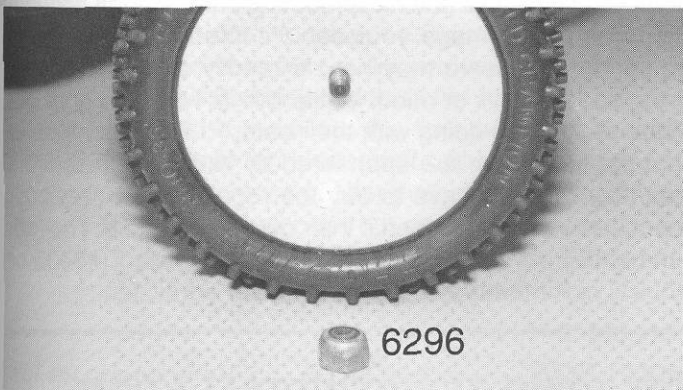
❑ **Fig. 147** Now you are going to use some Super Glue (cyanoacrylic glue) and glue the beads of the rear tires to the rims. Pull back gently on the tire in about five or six places evenly around the wheel, placing a drop or two of the Super Glue in each location. When the glue has dried you can turn the tire and wheel over and do the other side the same way. Go ahead and do the second tire and wheel. **WARNING: Super Glue can be dangerous to you. Use safety goggles or glasses, and gloves. Also make sure you follow all of the glue manufacturer's safety precautions!**




**Fig. 147**

□ **Fig. 148** In bag #6-8 you will find two #6296 8-32 aluminum locknuts. Now slide one of the rear tire and wheel assemblies onto the rear axle as shown. Make sure the slot in the back of the wheel aligns with the pin in the axle and then goes over the pin. Now do the same for the other wheel assembly. Now take the two 8-32 locknuts and thread them onto the rear axles to secure the rear wheels and tires. You can install the nuts with a pair of pliers, but it will be much easier with a 11/32" nut driver or socket.

If the rear wheels do not come off easily when you want to remove them, then loosen the locknuts until they are just a couple of threads from coming off. Now grab the back-side of the rear wheel and tap the locknut on the end of the axle, preferably with the plastic handle of a tool. Do this until the back side of the wheel clears the pin in the axle. You can then remove the locknut and unthread the wheel from the axle.

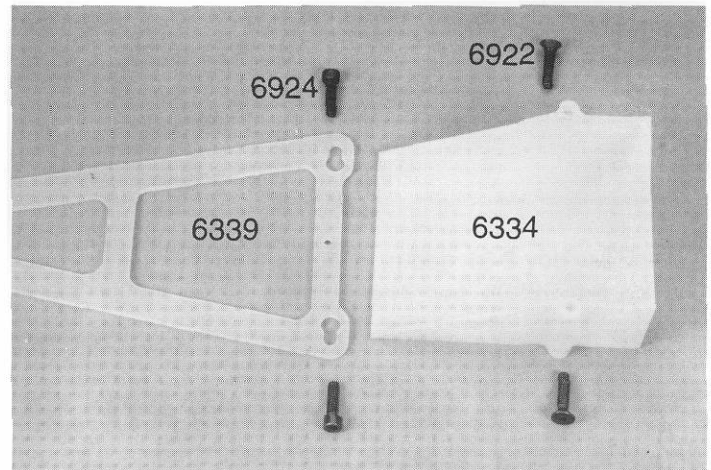


 #6296  
8-32 locknut

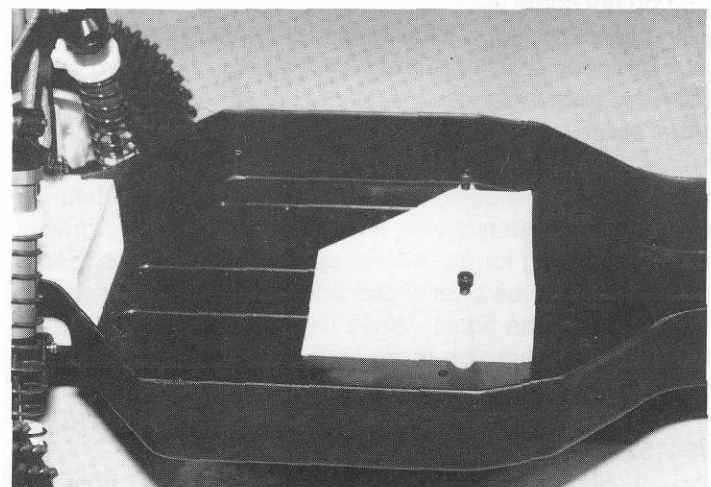
**Fig. 148**

□ **Figs. 149, 150 & 151** In bag #6-7 you will find the #6334 nylon battery cup and two #6922 4-40 x 1/2" FHSScrews. Use the two #6922 FHSScrews to fasten the battery cup to the chassis as in fig. 150.

Now get the two #6924 4-40 x 3/8" SHCScrews and the #6339 fiberglass battery hold-down strap from the bag. Thread the two #6924 SHCScrews into the two holes on top of the battery cup as shown in fig. 150. To install the battery strap (after you have installed the battery pack), slide the rear end of the strap into the battery slot in the rear bulkhead. On the opposite end of the strap, place one side over the screw of the battery cup. Slide the strap to the side so the head of the screw is over the smaller section of the key hole slot. While holding this end tight, you will need to flex the other side of the battery cup until the second screw lines up with its hole in the battery strap. Push the strap down over the screw head and then release the pressure on the battery cup. Your batteries would now be locked in; you just reverse the steps to remove the strap. Your completed rolling chassis will now look like fig. 151.

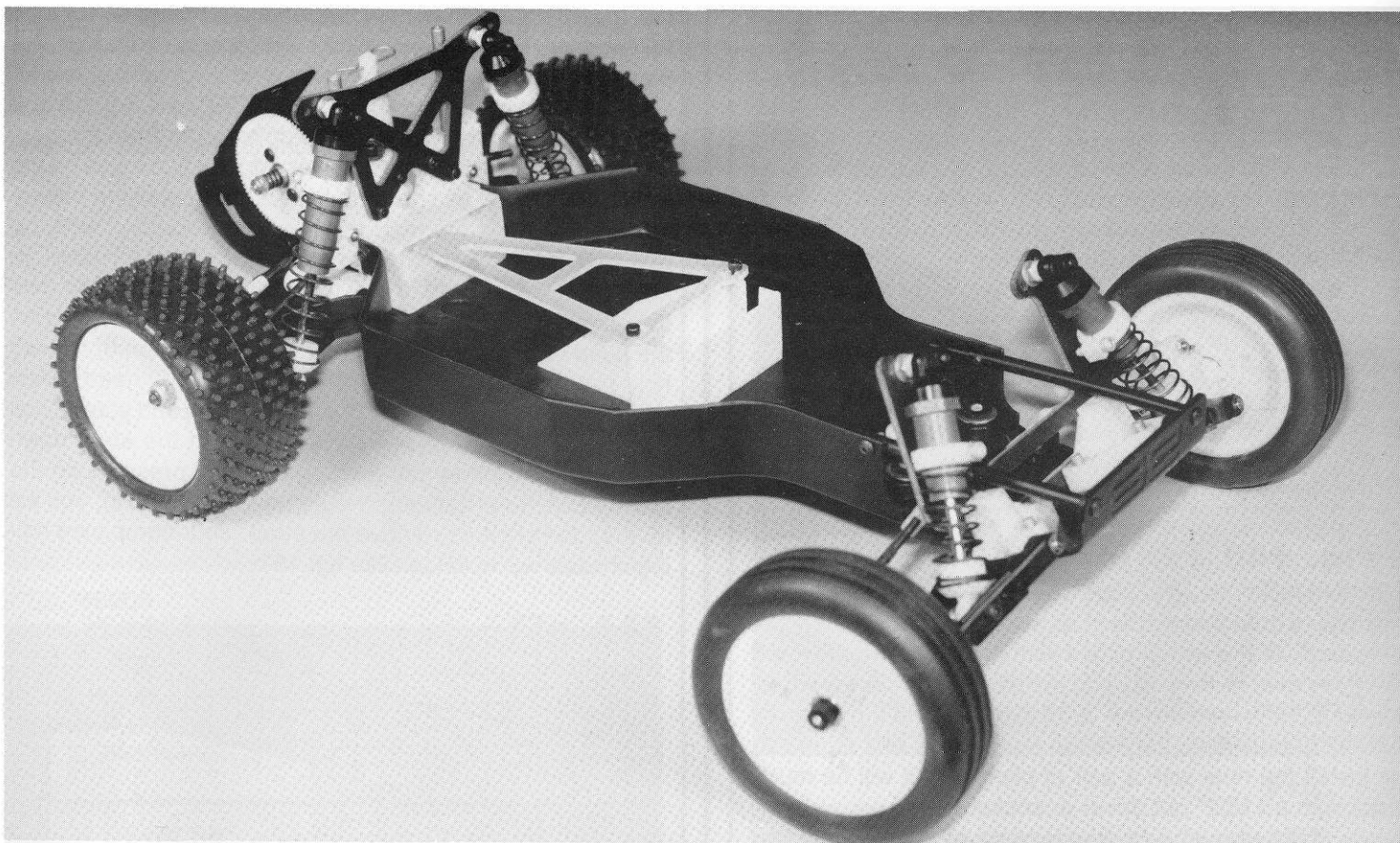


 #6922 4-40 x 1/2     #6924 4-40 x 3/8    **Fig. 149**



**Fig. 150**





**Fig. 151**

---

## **RADIO AND ELECTRICAL INSTALLATION**

We are now ready to install all of the components that do not come with your new car kit. The first item we are going to install is the steering servo. **WARNING! Because our new bell crank steering system has no servo saver feature, you must decide to add a servo saver, or use your steering servo without a servo saver feature.**

Selecting a good servo is very important if you are going to race competitively. While just having a ball bearing servo for consistency was important a while back, drivers are now looking for more from their steering servos. Some of the new servos offer metal internal gears in addition to quicker response times. While these servos are a little bit heavier, they give you more consistent results and longer servo life, but they cost more.

Some of the new metal gear servos are: #94151 or #94152 from Airtronics and #9302 from Futaba.

Standard high speed servos are: #94737 from Airtronics, #9301, #9401, or #9101 from Futaba, and #4135, #4721, #4731 or #4735 from J.R. Propo. There are many more servos available than what are listed here, but these represent what seem to be used by most racers.

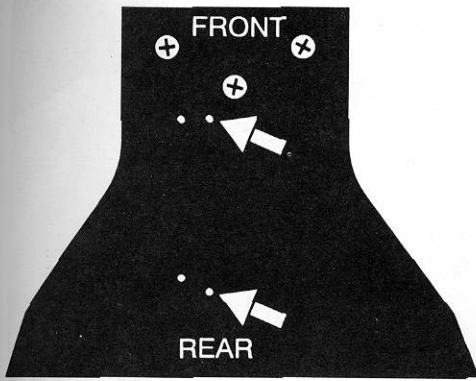
---

If you are running one of the new, all-metal gear servos, or if you feel your driving is good enough, you may choose to run a standard servo horn and no servo saver. If you make a mistake and hit something hard enough, though, then you can damage your servo's internal gears. Servo gears for your servo may not be readily available in your area, so keep this in mind. While this is what many of our Team drivers are doing with their cars, PLEASE remember that many of them are sponsored by radio manufacturers and they may not have to buy the repair parts or replacement servo they may need if their own is damaged. The recommended servo saver is the large Associated (#8435 or #5551) or Kimbrough large servo saver equivalent.

---

### **STEERING SERVO INSTALLATION - MEDIUM SIZE SERVO**

□ **Fig. 152** All of the servos mentioned above are medium size servos; we no longer recommend using small servos. In fig. 152 you will see four mounting holes. For a medium size servo we will use the two holes closer to the centerline of the chassis and spaced further apart, as indicated by the arrows.



**Fig. 152**

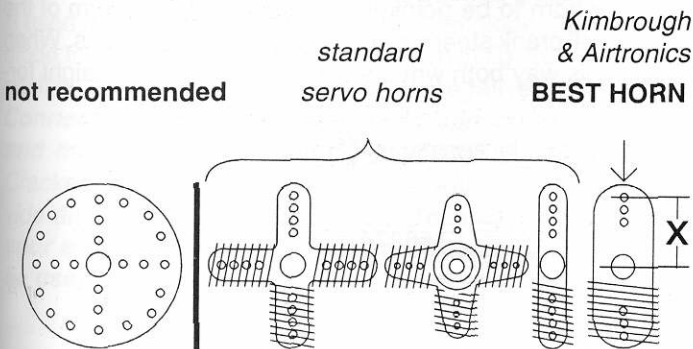
Medium size servo mounting holes (bottom view shown).

□ **Figs. 153, 154 & 155** Now you need to decide whether to use a servo horn or servo saver. Servo horns come in several different styles that must be modified to fit. Fig. 153 shows some of the more common styles of servo horns used in off road racing. The preferred is the aftermarket heavy duty Kimbrough or Airtronics style servo horn. Your servo horn should look like one of the other three shown. If you have a round servo horn, you will need to find a replacement, because they will not work in our car. Whichever type you have, remove the shaded areas as in fig. 153.

Now measure your servo horn or servo saver from the center of the splined mounting hole to the outside hole (on the longest arm), fig. 154. If the distance is  $3/4"$  (.750" or 19.1mm) or greater, you can mount the ball end on the back side over the servo. If the distance is less than the above measurements, then mount the ball on the front of the servo horn or saver.

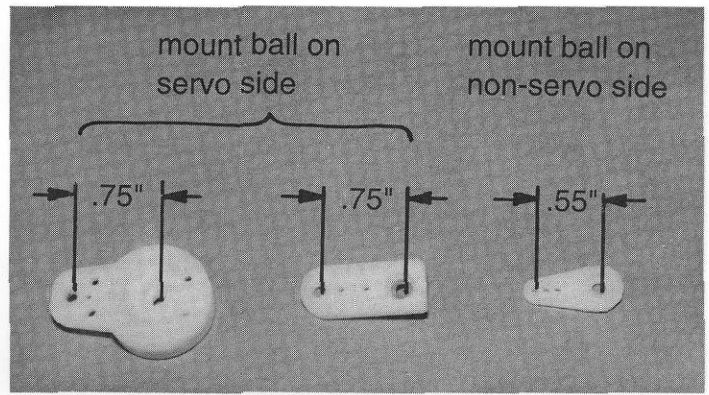
From bag #6-14 remove one #6270 short steel ball end and one #7260 4-40 small pattern nut. Thread on the ball end in the hole closest to  $3/4"$  (.75" or 19.1mm), on the correct side according to your measurements. **Note:** On most servo horns or servo savers you will have to enlarge the mounting hole before you install the ball end. The best way to do this is to ream out the hole with your X-acto® knife. Reaming from both sides will help prevent the servo horn or saver from cracking. After the ball is installed, thread on the #7260 4-40 small plain nut on the other side.

**TYPES OF SERVO HORNS**



(NOT ACTUAL SIZE)

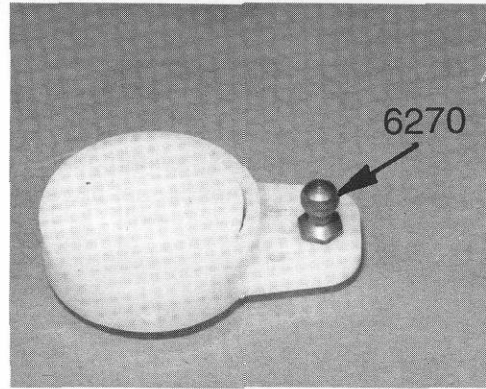
**Fig. 153**



#6270  
4-40

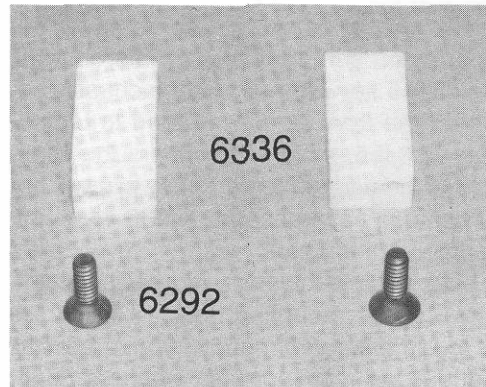
#7260  
4-40  
thin plain nut

**Fig. 154**



**Fig. 155**

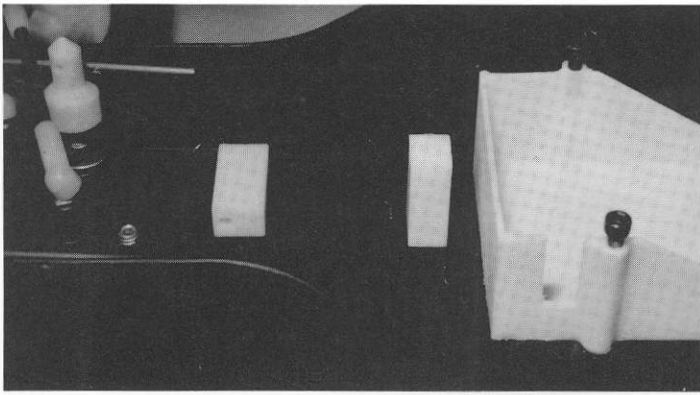
□ **Figs. 156 & 157** In bag #6-6 you will find two #6336 nylon servo mounts and two #6292 4-40 x  $3/8"$  FHSScrews. For now, we will temporarily install the servo mounts so we can mark them for drilling to fit your servo correctly. Fasten the servo mounts to the chassis with the two #6292 FHSScrews so that the thicker portion of the mount is towards the driver's side of the chassis. **Note:** The remaining steps will show installing the #8445 servo saver because this is the more complex installation.



**Fig. 156**

#6292  
4-40 x  $3/8"$





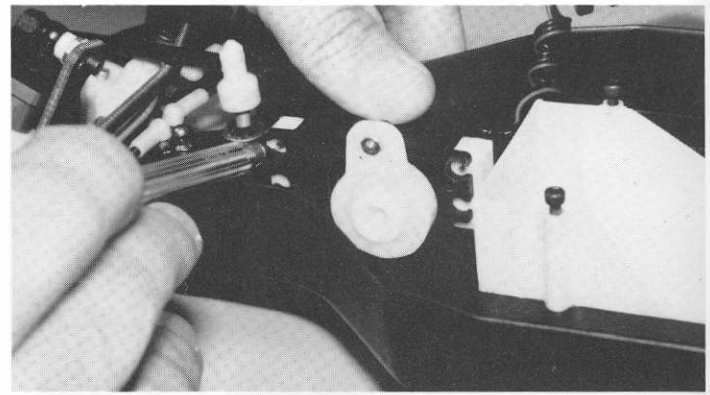
**Fig. 157**

□ **Fig. 158** Mount the servo saver so that it is pointing straight up as shown. Now check to make sure you have almost equal travel for the servo saver in both directions. If you don't, remove the servo saver, rotate the mounting position one spline in the direction needed and then remount the servo saver. Do this until you have almost equal travel in both directions.



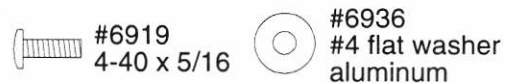
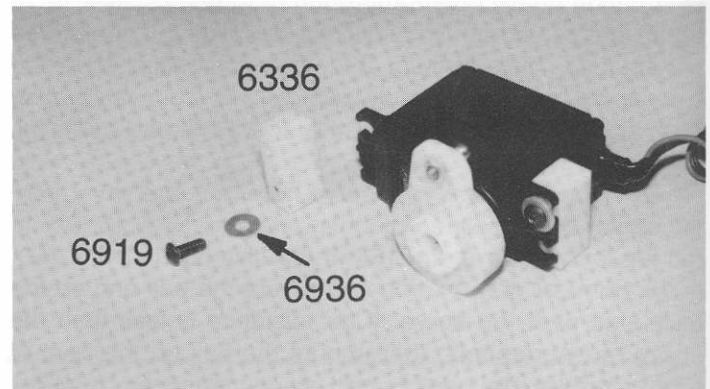
**Fig. 158**

□ **Fig. 159** Place your servo with servo saver between the two #6336 nylon servo mounts on the chassis. You will see that the #8445 servo saver hits the chassis before the servo goes on the front side. You need to temporarily raise the servo until the servo saver clears the chassis. (With a standard or heavy duty servo horn this will not be necessary.) You can use several of the #6936 #4 aluminum washers to accomplish this. Once the servo saver clears the chassis, slide it back against the servo mounts and mark the centers of the two upper mounting holes. If the holes are too close to the top of the servo mounts, you can install one or two of the #6936 #4 aluminum flat washers under each mount to raise them. Now remove the two servo mounts and drill your marked holes with a #43 drill bit (a 3/32 drill bit will work if used carefully).



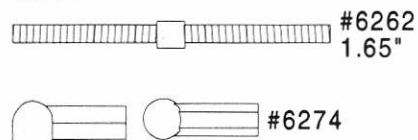
**Fig. 159**

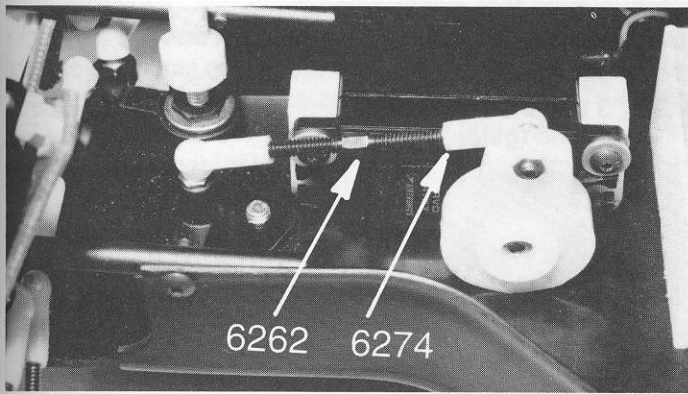
□ **Fig. 160** Now remove two #6936 #4 aluminum flat washers and two #6919 4-40 x 5/16" BHSScrews from bag #6-6. Use these screws and washers to mount the servo to the servo mounts as shown. Reinstall the servo onto the chassis. If you had to raise the servo mounts, use the same number of washers under the mounts to reinstall the servo.



**Fig. 160**

□ **Fig. 161** In bag #6-2 you will find the #6262 1.65" turnbuckle. In bag #6-14 you will find the remaining two #6274 plastic ball end caps. Thread on the two plastic ball end caps. Because each servo horn or servo saver can be a different size, there is no pre-established length for this turnbuckle. To properly set up this turnbuckle, you will want the servo saver or horn to be pointing straight up and the arm of the #6254 bell crank steering pointing across the chassis. When set up this way both wheels should be pointing straight forward.





**Fig. 161**

## MOTOR INSTALLATION

□ **Fig. 162 & 163** Now it is time to take out your stock or modified motor so that we can install it. Your kit does not come with a motor or pinion gear, so you will be installing the motor and pinion you bought separately.

First, depending upon your motor, you may need to install your motor capacitors and Schottky diode. **WARNING!!! IF YOU ARE RUNNING A SPEED CONTROL WITH REVERSE, DO NOT INSTALL A SCHOTTKY DIODE ON YOUR MOTOR! Installing the diode with a reverse speed control will destroy the speed control!!!**

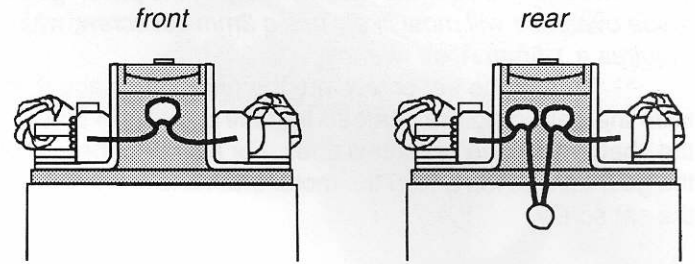
**CAPACITORS.** You will want to install a total of three .1uf 50 volt capacitors (it does not matter which brand or size). If your motor already has some installed, just add the ones still needed to bring the total to three. Capacitors are mounted as follows (fig. 162): one goes from the can (stock motor) or can grounding tab (modified motor) to the positive terminal, another goes from the can or can grounding tab to the negative terminal, and the third goes from the positive terminal to the negative terminal. **Note:** Make sure that each lead of a capacitor only touches a lead of another capacitor connected to the same terminal or can grounding point.

**SCHOTTKY DIODE.** If you have a high frequency speed control (without reverse) like the Novak HPC or Tekin 411-G you should install a Schottky diode. This diode will give you more consistent brakes, make your motor run more efficiently, and allow your electronic speed control to run cooler.

The diode has a silver band painted on one end that is used to identify the positive side of the diode. Connect the diode to the tabs of the motor as shown in fig. 163, soldering positive to positive and negative to negative. **WARNING: Connecting the diode backwards can crack the diode and make the car act like the motor is shorted out. Cracked diodes should be replaced with new ones to provide all of the above advantages. To prevent damage to your electronic speed control a Schottky diode should be used at all times (except on reverse models).**

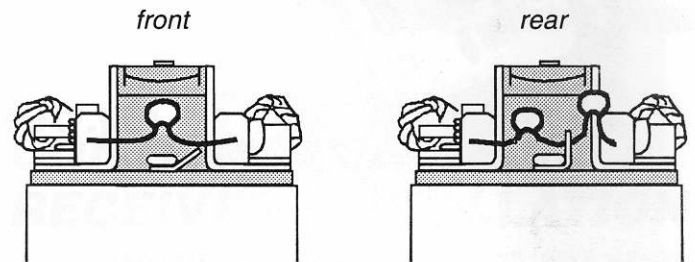
**MOTOR PLUG CONNECTOR.** If you are going to use a motor plug connector, install one now. Our Team drivers hard wire (direct solder) the speed control motor leads to the motor. Connect the positive lead to the positive terminal of the motor and the negative lead to the negative terminal.

### STOCK MOTORS



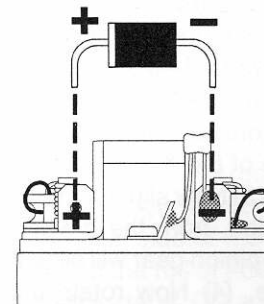
Add three capacitors where shown.

### MODIFIED MOTORS



Add three capacitors where shown.  
(NOT ACTUAL SIZE)

**Fig. 162**



Do not use a Schottky diode on a speed control with reverse. Solder positive to positive, and negative to negative.

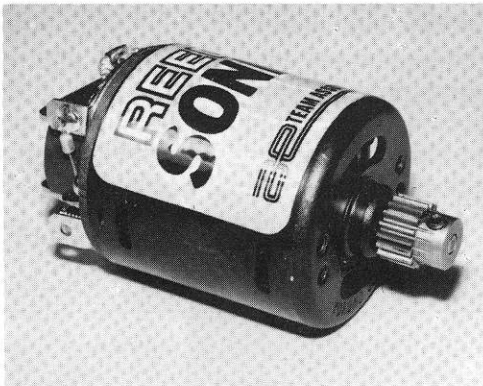
(NOT ACTUAL SIZE)

**Fig. 163**



□ **Fig. 164** Now you will need to locate your pinion gear and its appropriate set screw. **Note:** Most of the American made pinion gears use a 4-40 set screw, which requires an .050" Allen wrench. The few non-standard American made gears will use a 1/16" Allen wrench. Any of the pinion gears made overseas will most likely use a 3mm set screw, which requires a 1.5mm Allen wrench.

Thread the set screw into the pinion gear and then slide the gear onto the shaft so that the gear teeth go over the shaft before the set screw does. For now, line the end of the gear up with the end of the motor shaft and lightly tighten the set screw.



**Fig. 164**

□ **Figs. 165, 166 & 167** (1) In the master bag you will find a small bag containing the two #6515 gold 3mm x 6mm SHCScrews and two #6936 #4 aluminum flat washers. These gold colored screws are metric screws used only for mounting the motor to the motor plate. **WARNING! Do not use any of the black 4-40 screws to mount the motor. They can strip out the 3mm screw holes in the motor can, making the motor unusable.**

(2) Place one of the #4 flat washers on each of the #6515 motor screws. (3) Now slip the motor into the opening behind the transmission, from the driver's side, shaft end first. See fig. 165. The pinion gear will slide through the opening in the motor plate. (4) Now rotate the motor until the lower hole in the motor lines up with the lower motor mounting hole. (5) Thread the upper and lower motor screws and washers into the motor, but do not completely tighten the screws yet.

(6) Now we need to set the gear mesh. By moving the motor forward or back we will be moving the motor pinion gear closer to or away from the nylon spur gear. What we want to do is the get metal pinion gear as close to the nylon spur gear as we can without jamming the gears. The easiest way to check this is to put your finger on the plastic gear and see if you can rock it in the teeth of the metal pinion gear, but without moving the metal pinion gear. The gears should be as close as possible, but still have the ability to rock the plastic gear. (7) When you have the spacing correct you can go back and tighten both of the motor mounting screws. (8) Now recheck the gear spacing. It is important to

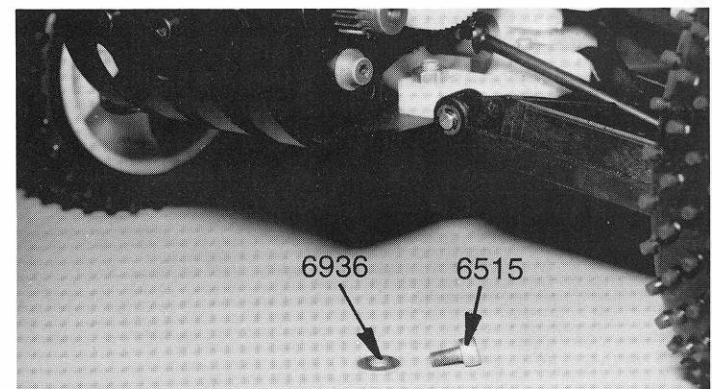
keep in mind that a tight gear mesh can result in a huge power loss, so take your time and do it correctly.

#6515  
3 mm x 6 mm  
metric (gold)

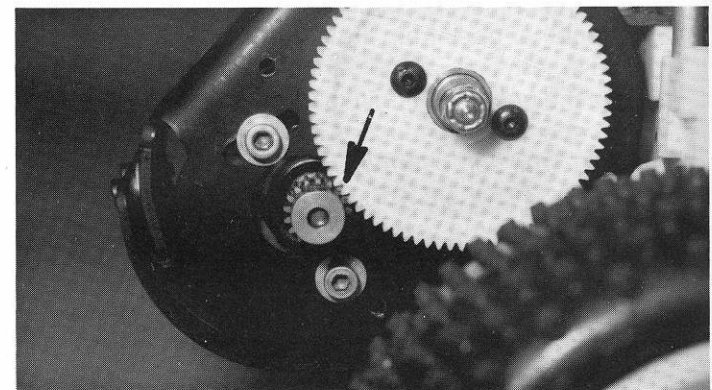
#6936  
#4 flat washer  
aluminum



**Fig. 165**



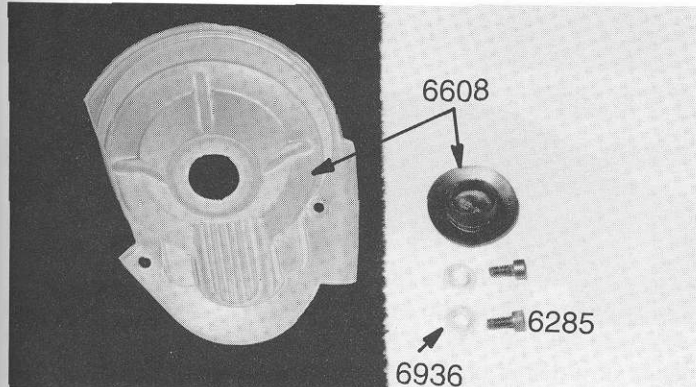
**Fig. 166**



**Fig. 167**

□ **Figs. 168, 169, 170 & 171** (1) In the Stealth transmission bag you will find the #6608 plastic gear cover with its black removable cap. (2) Trim around the outside of the gear dust cover (fig. 168) so that it will fit over the motor plate accurately, then (3) cut out the center button hole. (4) There are also two small dimples in the gear cover that mark the locations for the two mounting screw holes. Take a hobby knife and open up these holes. (5) In bag F of the transmission bag you will find two #6285 4-40 x 1/4" SHCScrews and two #6936 #4 aluminum flat washers. Use

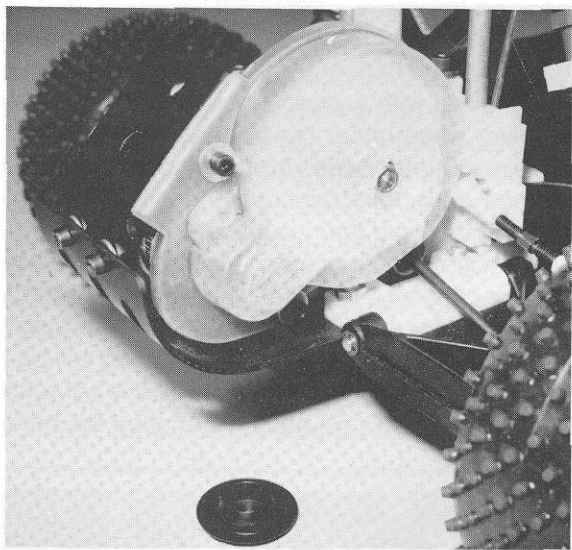
these to fasten the plastic gear dust cover to the motor plate (fig. 169). (6) You can now install the black removable cap into the gear dust cover (fig. 170). Remove the cap to adjust the transmission torque clutch with your 1/4" nut driver (fig. 171) in the future. **WARNING!** Before you can remove the motor from the car you must first remove the gear dust cover. Make sure you do not get the gold motor screws mixed up with the black dust cover screws. Mixing these up could cause you to strip out the motor can mounting holes or gear cover holes in the motor plate.



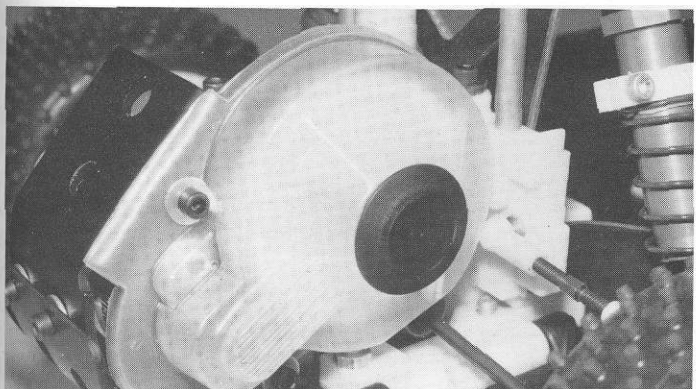
#6285  
4-40 x 1/4  
steel

#6936  
#4 flat washer  
aluminum

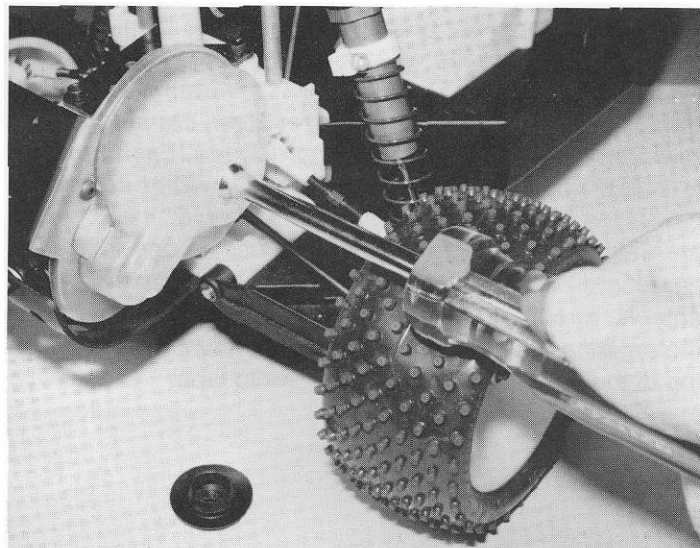
**Fig. 168**



**Fig. 169**



**Fig. 170**



**Fig. 171**

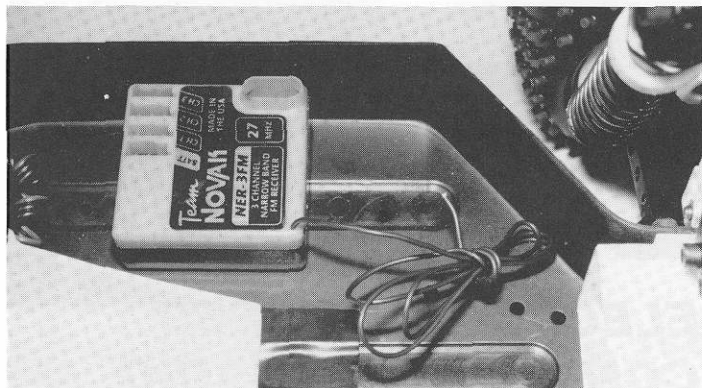
## ELECTRONIC SPEED CONTROL AND RADIO RECEIVER INSTALLATION

If you are serious about racing, then make sure you pick a quality radio such as Airtronics, Futaba, J.R. Propo, or K.O. Propo. This is an important part of your car system and can help eliminate possible problems. The same applies to the electronic speed control (ESC). Some radios come with one servo and an electronic speed control; make sure it is a good ESC. Most racers prefer to use aftermarket speed controls from companies like Novak or Tekin, which are the two top manufacturers of ESC's.

❑ **Fig. 172, 173 & 174** (1) Locate your receiver close to the antenna on the right side of the chassis as shown. If your receiver is too large to fit laying down, you will have to stand it on edge. If you have to do this, make sure you have the crystal side of the receiver up. (2) In the master bag you will find the roll of #6726 black servo tape, a double-sided foam sticky tape. Cut a piece to match the side of the receiver that you are going to mount to the chassis. Stick it first to the receiver then the chassis. **Note:** Team drivers will sometimes use two layers of servo tape to help provide better shielding from electrical interference. (3) Remove your #6338 antenna tube and mount from the master bag. (4) Feed the antenna wire up through the bottom of the #6338 antenna mount. (5) Fasten the mount to the chassis (in the location shown) using the #6922 4-40 x 1/2" FHSScrew that came with the mount. (6) Now feed the antenna wire through the antenna tube. (Keep the antenna tube as long

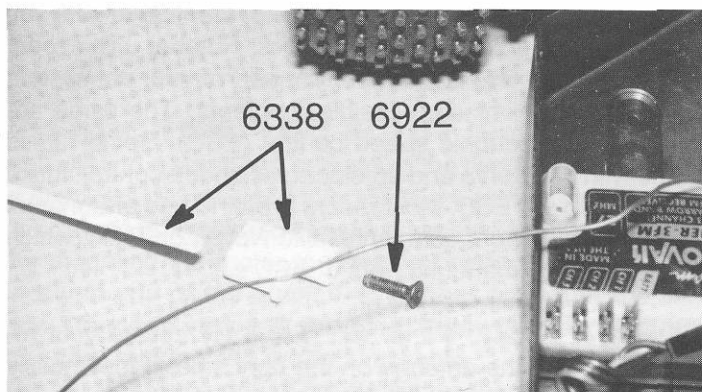


as possible, for radio range, but not to the point where it could get caught in the wheels or something else.) **WARNING!! Do not cut the radio receiver antenna wire. Cutting this wire could detune the receiver, causing severe radio interference or glitching problems. Each receiver is tuned for the length of antenna wire that comes attached to it.** If you have excess antenna wire, the appropriate way to store it is to wrap the excess around a piece of cardboard as shown in fig. 174. Make sure the antenna wire does not cross over itself, for that could shorten the antenna receiving range. You can mount the excess on top of the receiver with a piece of servo tape.

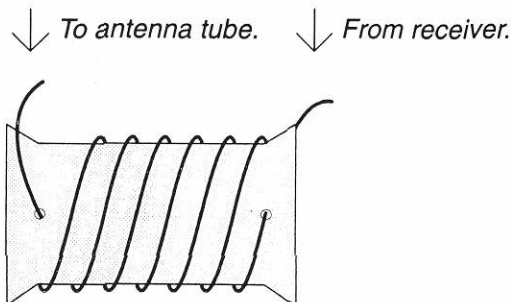


 #6922  
4-40 x 1/2

**Fig. 172**



**Fig. 173**

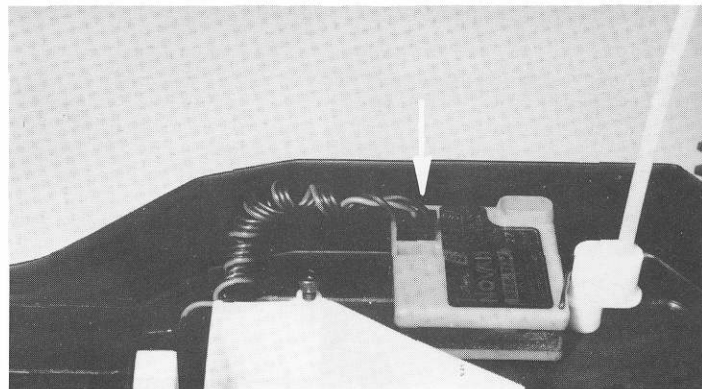


If you have excess antenna wire, wrap it around a piece of cardboard. Do not let the antenna wire cross over itself.

(NOT ACTUAL SIZE)

**Fig. 174**

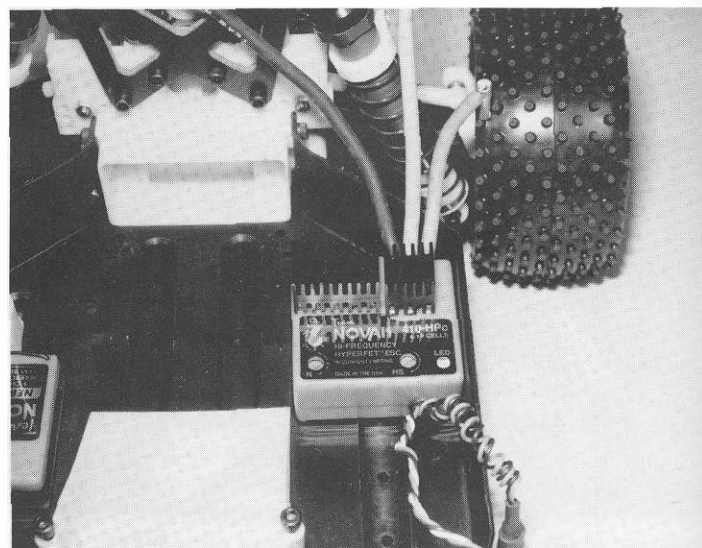
**Fig. 175** Now that the receiver is mounted we can install the steering servo plug into the channel 1 (or rudder) slot on the receiver. Bundle the excess steering servo wire and secure it with one of the small wire tires supplied with the kit. Try to keep the excess wire as far away from the receiver as possible.



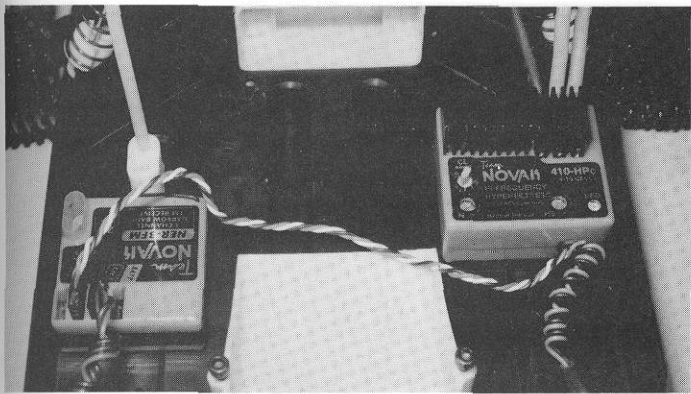
**Fig. 175**

**Fig. 176 & 177** Mount your speed control as far back on the driver's side of the chassis as possible using another piece of servo tape. This location helps you keep the motor and battery wires as short as possible. Your chassis is milled with a cross slot for running the speed control receiver wires under the battery. **Racer's Tip:** To prevent the speed control wires from being damaged, racers will put a piece of electrical tape over the wires going under the battery pack to hold them in place.

Now you can insert the speed control receiver plug into the channel 2 (throttle) slot of your receiver. When using electronic speed controls you do not use the receiver battery slot with normal setups. Everything will be powered by the speed control through channel 2. We will solder the speed control wires after we have assembled the battery pack.



**Fig. 176**



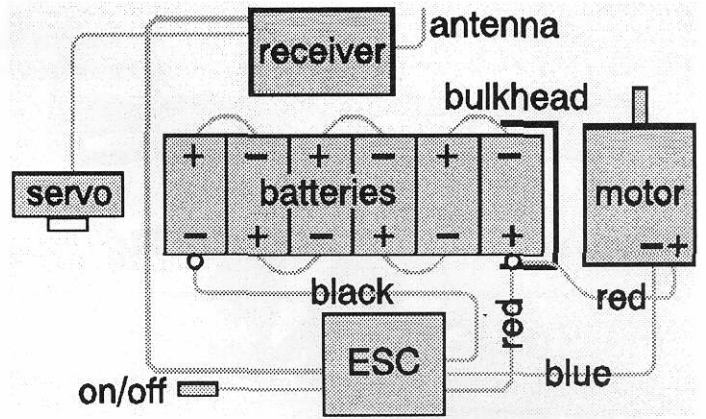
**Fig. 177**

## BATTERY PACK ASSEMBLY

Your kit does not come with a battery. The following instructions will help you set up the batteries correctly, and eliminate some possible electrical problems. Our example here will be for a six cell matched pack, which you must assemble. If your battery pack is assembled differently you will have to adjust your layout accordingly. **Note:** *With the amount of power available with today's motors, we almost exclusively run six cells in our Team buggies.*

Soldering is a skill that can be developed by anyone. To solder a battery pack there are two important things to keep in mind. First, use a good soldering iron with at least 40 watts of power. It is possible to use a soldering gun, but they are bulky, awkward and do not apply the heat to the tip as well as a soldering iron. Make sure you tin (lightly solder) each part before you try to assemble them. This improves the heat transfer during soldering and the parts will bond better and faster. Secondly, use a high quality 60-40 rosin core solder. Small diameter solder is easier to work with. **WARNING! DO NOT use "acid" core solder. Acid core solder will damage electrical components. Use only ROSIN core solder for electrical connections.**

**Fig. 178** First you will need to determine the layout of your battery pack. The first thing to keep in mind when laying out your batteries is to *keep the positive lead as short as possible*. This helps reduce power loss and improves efficiency. Therefore, because the speed control (ESC) is in the driver's side corner, the positive terminal of our battery pack should be in the same corner. Also, for our battery pack to have the right voltage for our application, the cells will need to be soldered in series. This means the positive end of the first cell will need to be soldered to the negative end of the second cell, and its positive end will be connected to the negative end of the third cell, and so on. Fig. 178 shows where each cell will be soldered when we start with the positive end in the back left corner. Details of soldering follow in figs. 179-181.

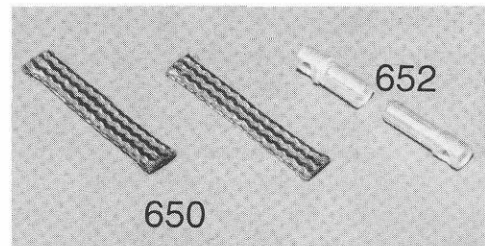


front of car

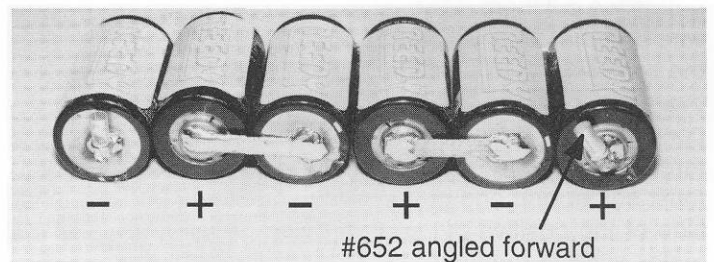
rear of car **Fig. 178**

*Keep the positive battery lead (red wire) close to the ESC.*

**Fig. 179, 180 & 181** Use either battery braid or battery bars to connect your cells. Battery braid is cheaper and easier to solder, but battery bars help to make the battery pack more rigid. Associated sells precut Reedy #650 battery braid for soldering battery packs. Now go ahead and solder your battery pack and #652 power connector pins. When completed, the driver's side of the pack should look like fig. 180 and the passenger side like fig. 181. Please note that the positive power pin connector is soldered to the forward side on the battery and angles forward as well. This is done so that it will clear the rear bulkhead easier.



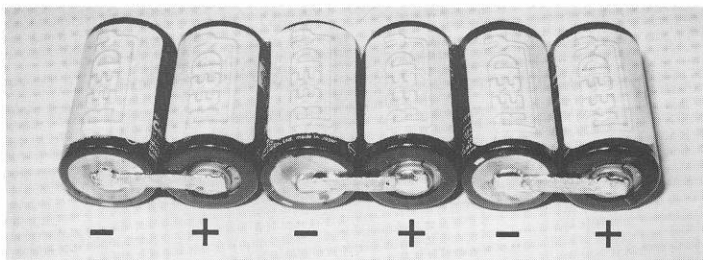
**Fig. 179**



driver's side end view

**Fig. 180**

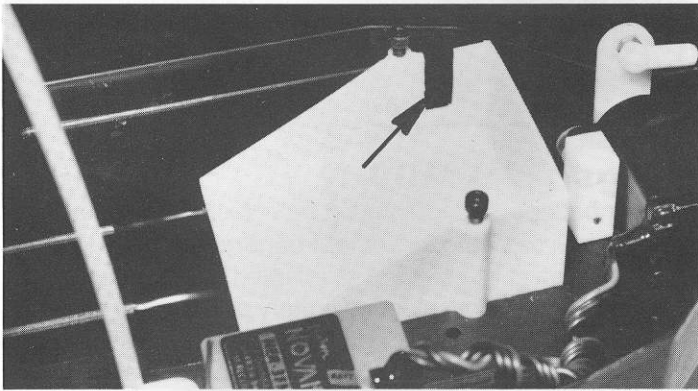




passenger's side end view

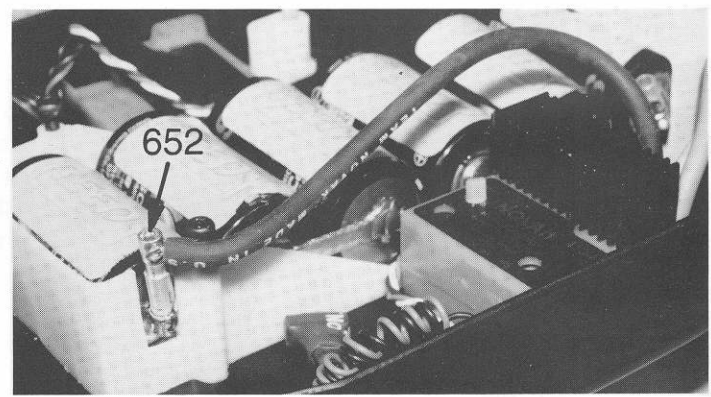
**Fig. 181**

□ **Fig. 182** Before we can install the battery pack into the car, we must notch the battery cup as shown in fig. 182 so that the battery connector pin socket will fit.

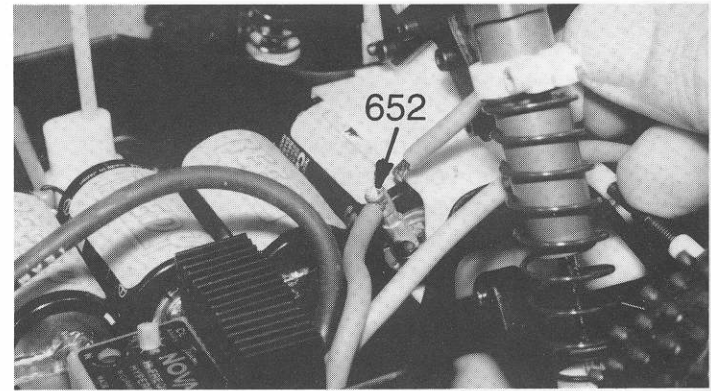


**Fig. 182**

□ **Figs. 183 & 184** Now we are going to hook up your speed control battery leads to our battery pack. We are using the new Reedy #652 power connector pins in our example. These pins make for an easy battery connect and disconnect system and have almost no power loss. (1) We will start with the positive terminal. Install the battery into the battery cup (make sure the positive connector is in the back left corner). (2) Now push the pins into the pin sockets. We are doing this so we can measure the wire lengths before we cut them. Make sure you leave a little slack in the wires so that they will not be hard to push in or pull out of the sockets. (3) Now solder the negative wire to the negative pin connector and the positive wire to the positive pin connector. (4) Because the speed control we are using is a three wire system, after you cut the positive lead wire you must solder one end of the piece you cut off into the other side of the positive pin so that it can be used to go to the motor positive terminal.

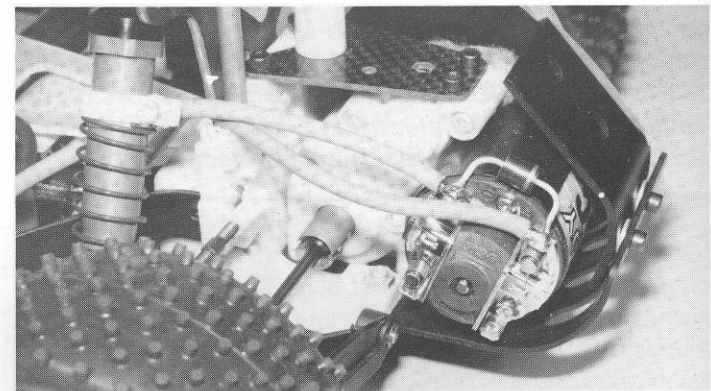


**Fig. 183**



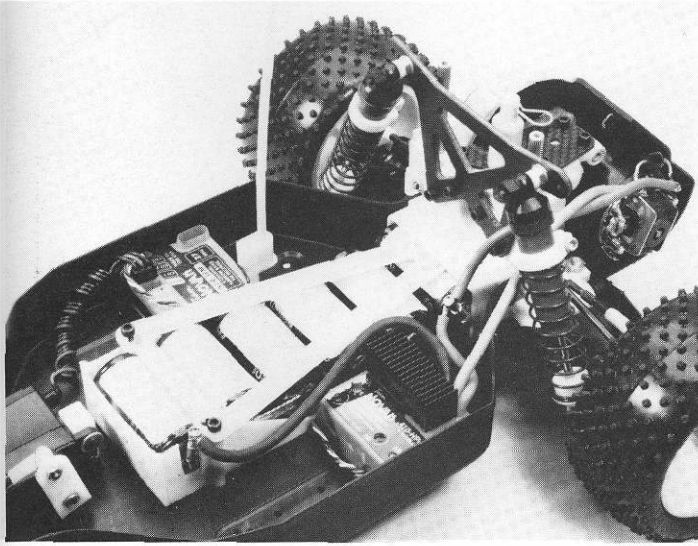
**Fig. 184**

□ **Fig. 185** Now measure the motor lead wires to cut them to the right length (make sure you leave some slack in the wires), then solder them onto the motor.

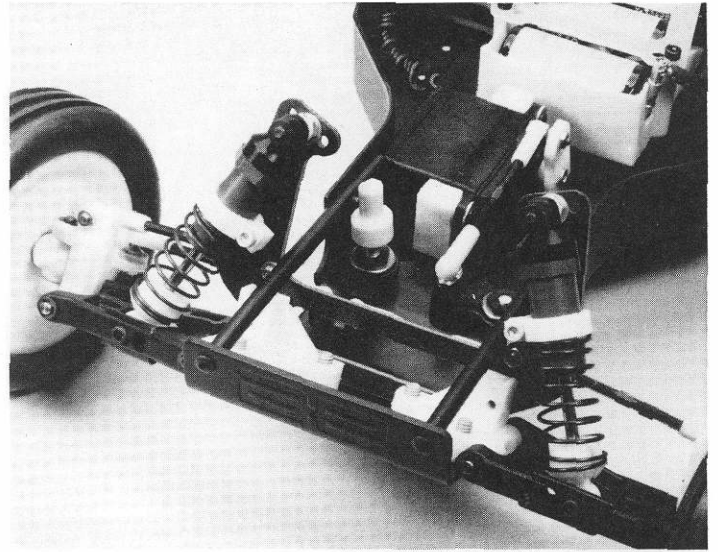


**Fig. 185**

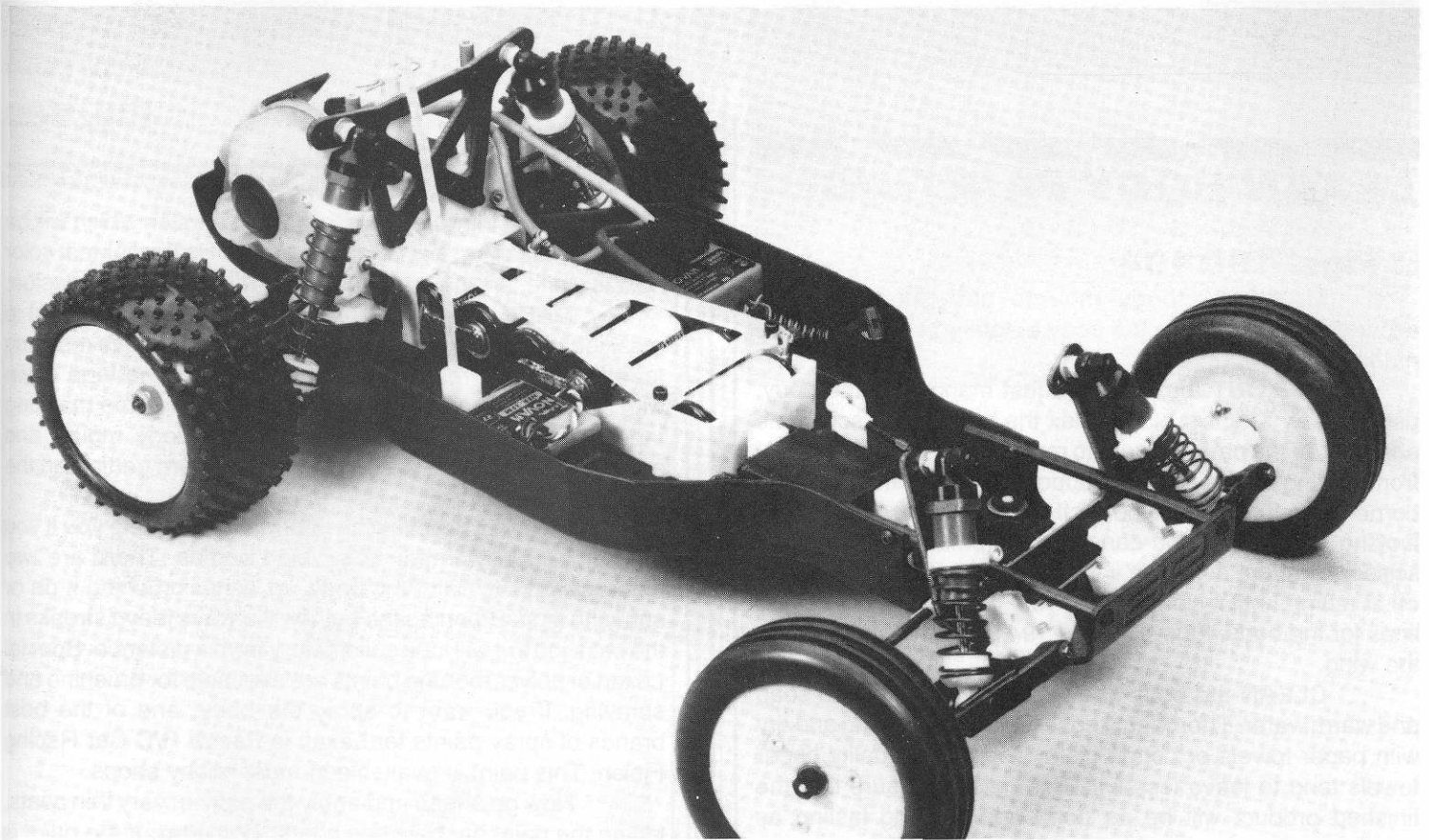
□ **Figs. 186, 187, 188 & 189** Go ahead and install your battery hold down strap over your batteries. If you do not remember how, you can refer back to figs. 149 to 151. Your completed car will now look like figs. 186-189.



**Fig. 186**



**Fig. 187**



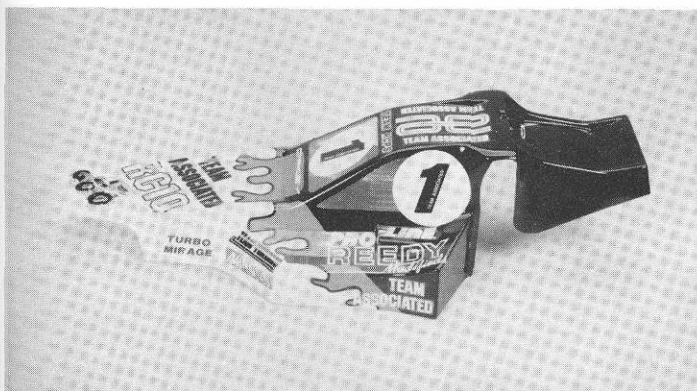
**Fig. 188**



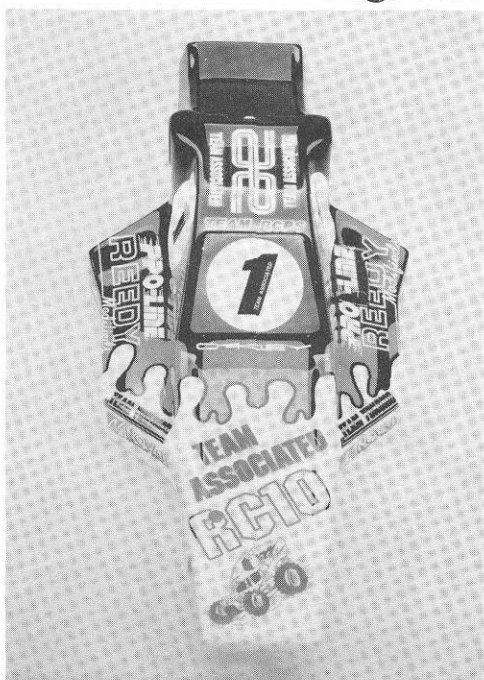
If you make a mistake applying paint, the only product that we have found that can remove the paint or overspray without damaging the Lexan is Synthetic Reducer (if used properly). It can be purchased through a automotive paint supply store.



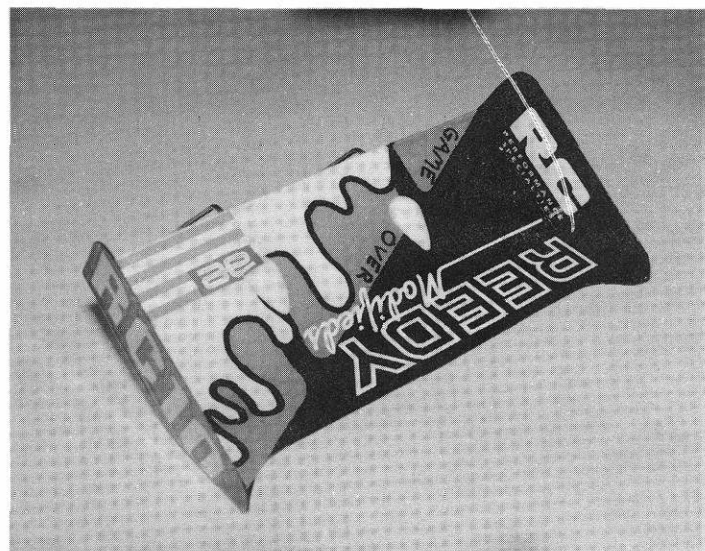
**Fig. 190**



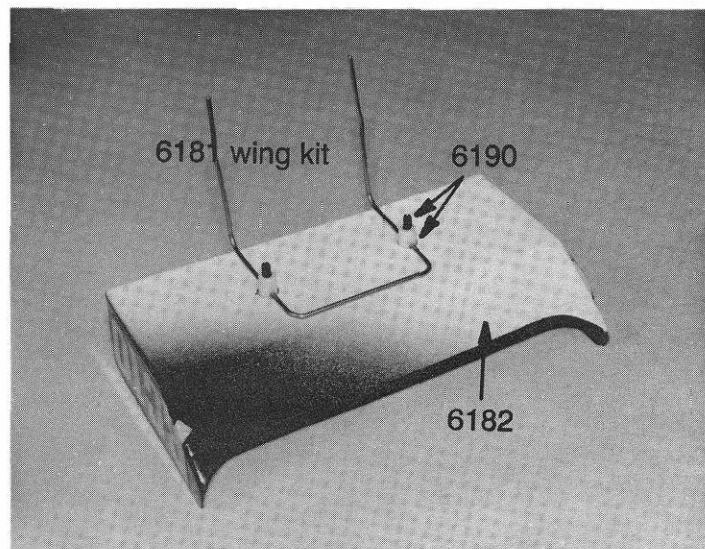
**Fig. 191**



**Fig. 192**

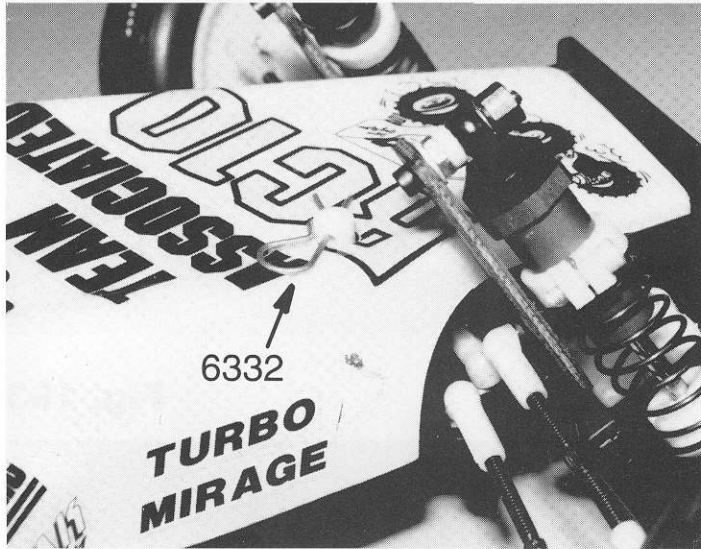


**Fig. 193**



**Fig. 194**

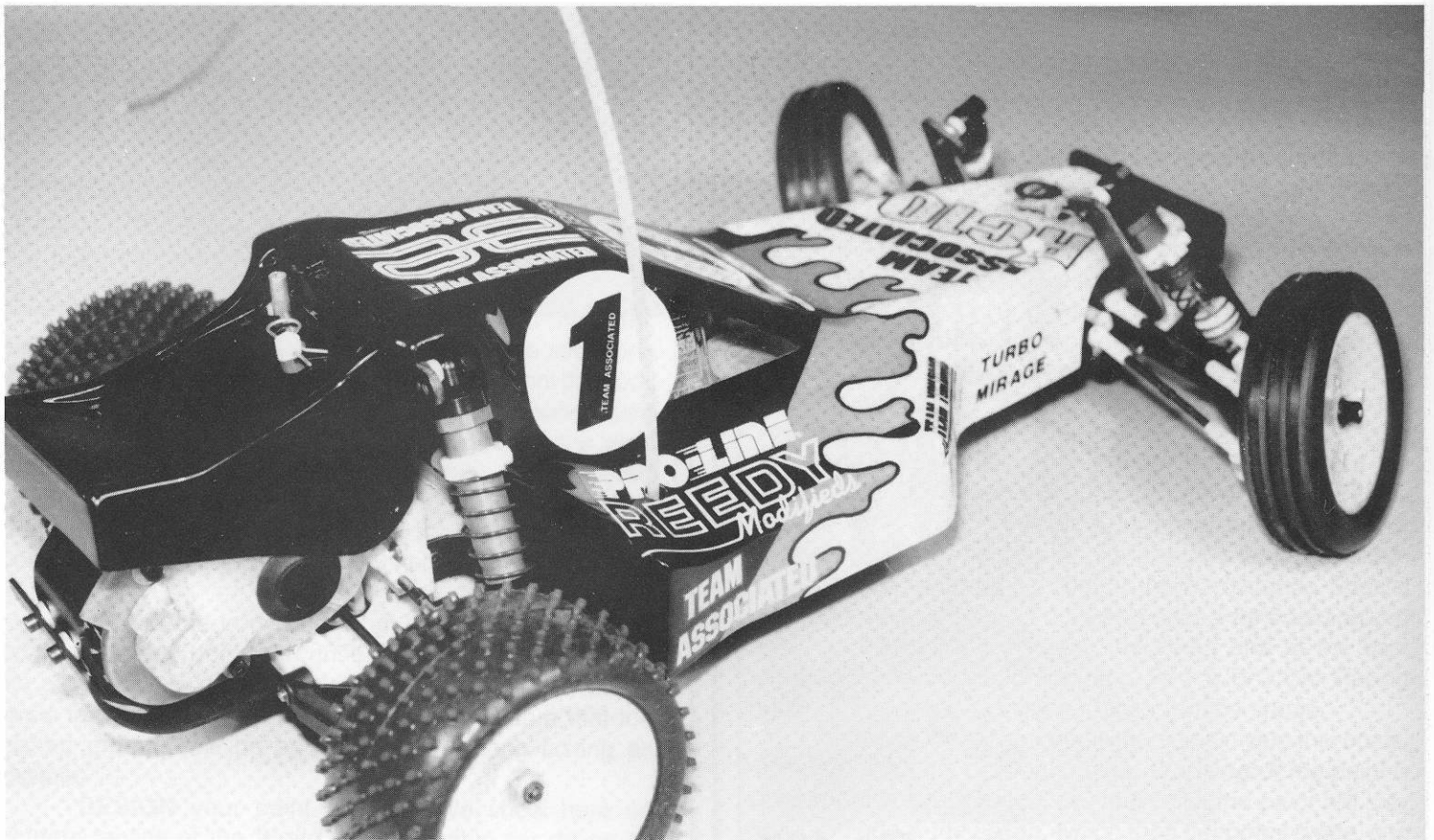
□ **Figs. 195, 196, 197 & 198** You may add the decals supplied with the kit, or customize it with decals from your local hobby shop. After the body is finished, place it on the chassis so that both body mounts are coming through the body holes. Now install the #6332 body clips through the body mounts. Fig. 195 shows the front of the body with the body clip installed; fig. 196 shows the wing mounted. Fig. 198 shows the finished product.



**Fig. 195**

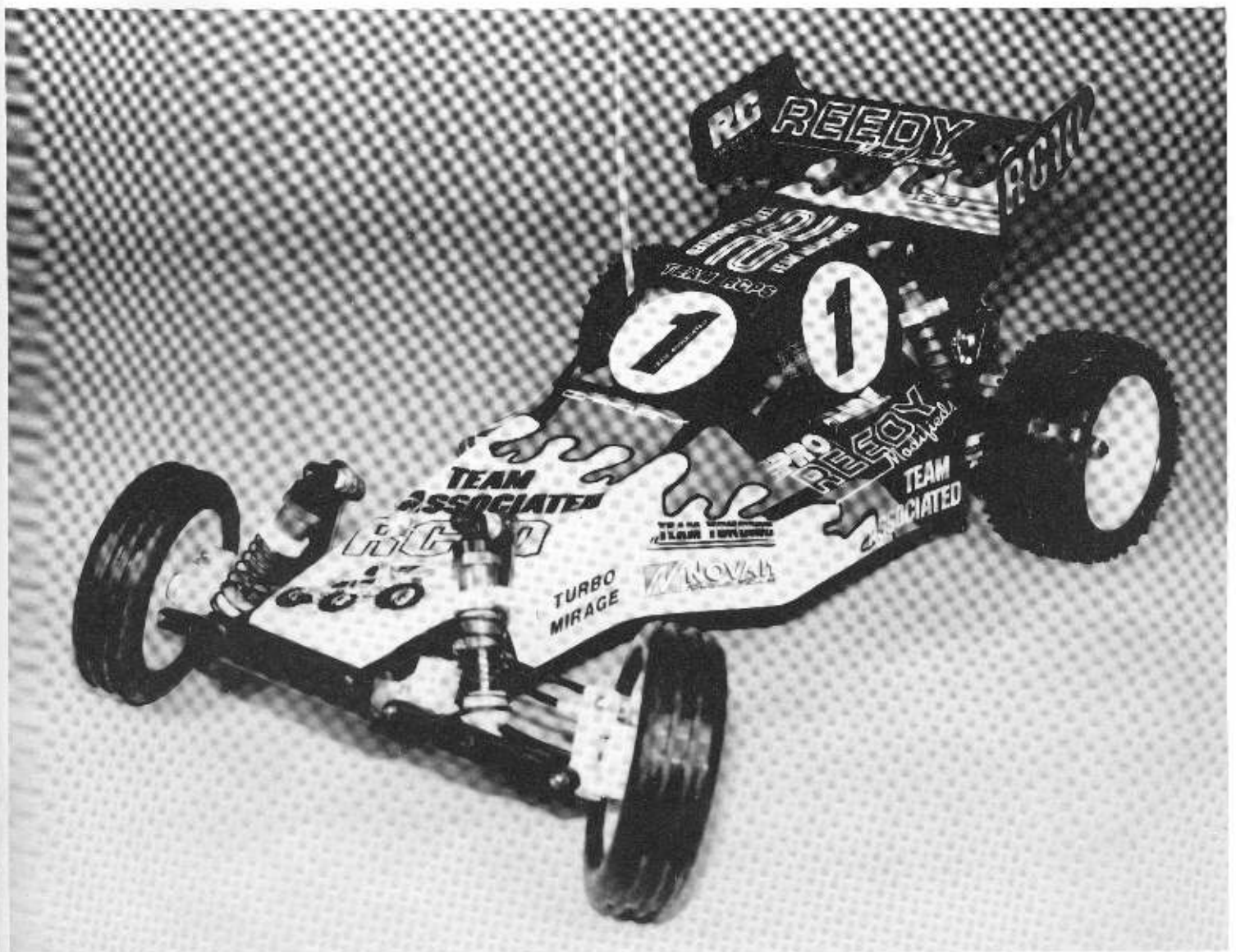


**Fig. 196**



**Fig. 197**

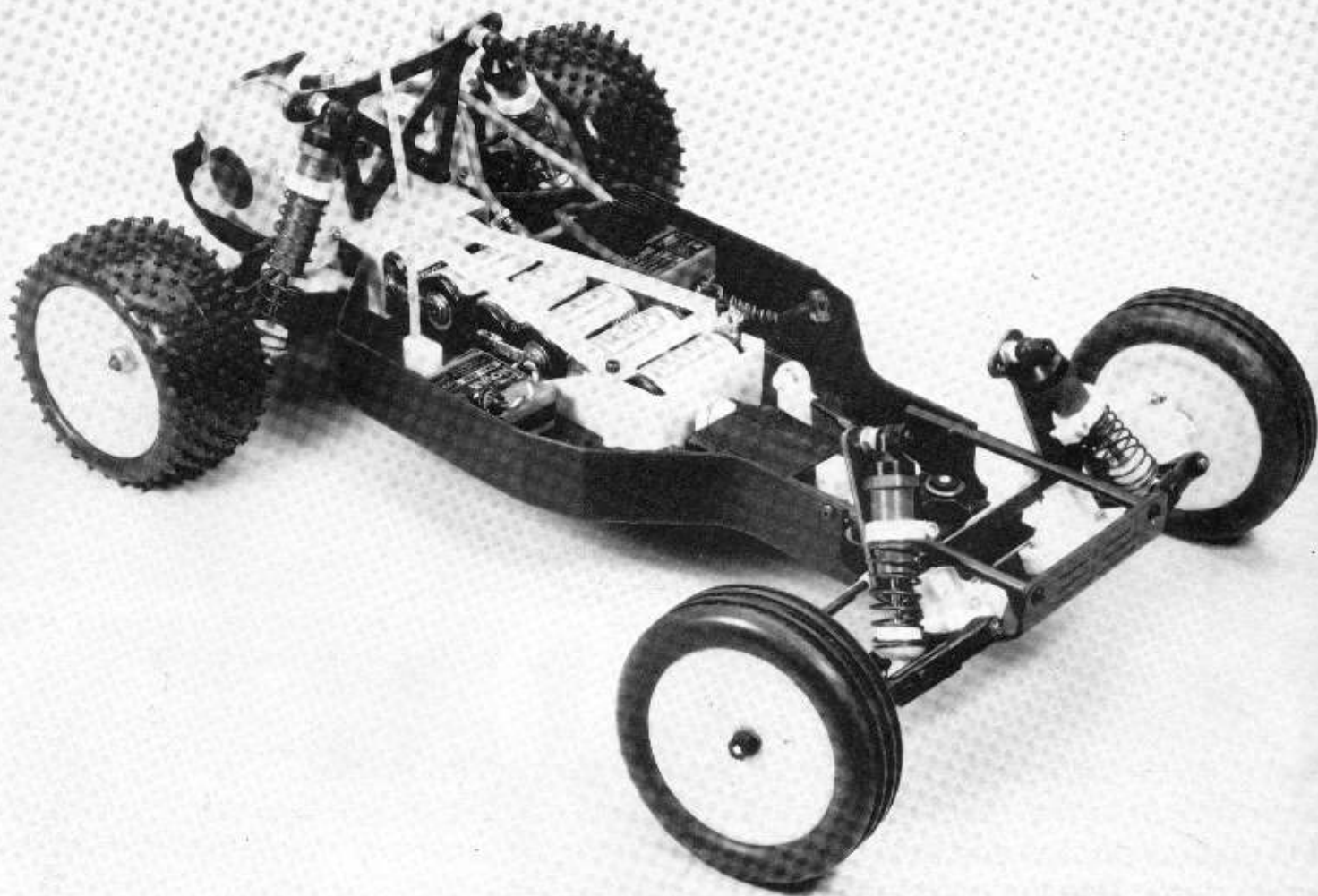




**Fig. 198**

**SAVE THIS MANUAL!** This is more than an instruction manual. It is also a handy supplement to the Team Associated 1:10 scale off road buggy catalog. You can use the manual photos and descriptions to identify part numbers and names to help you order parts. Use the current catalog for pricing.

# WORLD'S CAR



**22 TEAM ASSOCIATED**

© 1994 Associated Electrics, Inc.

3585 Cadillac Ave.

Costa Mesa, CA 92626

(714) 850-9342