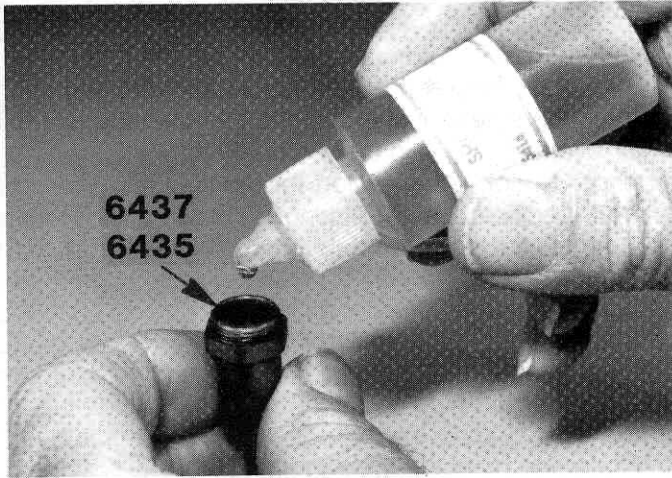
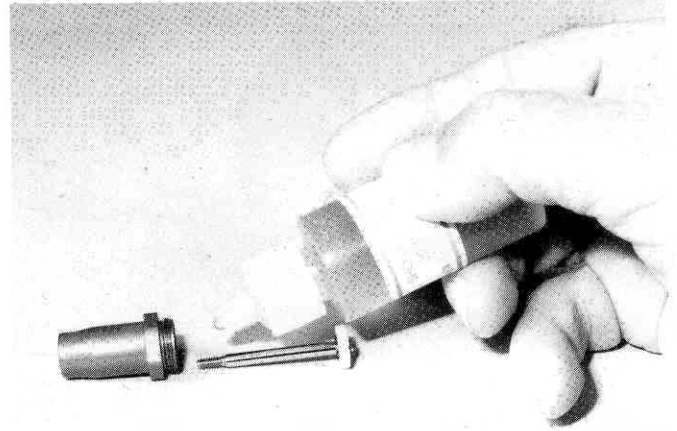


□ **Fig. 94** Put a few drops of oil into the #6426 front and #6424 rear shock bodies to make assembly easier also. We don't want to cut the red O-rings on assembly.



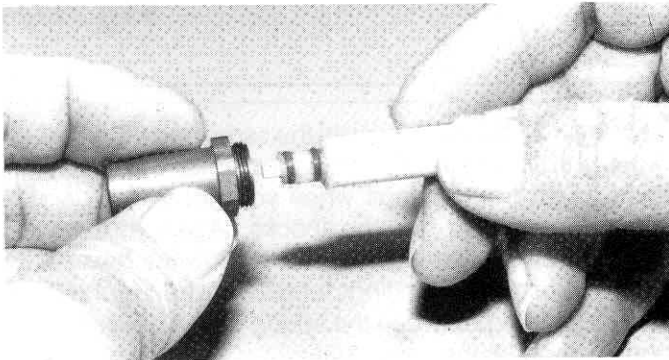
**Fig. 94**

□ **Fig. 98** After the split washer is fully seated, place a liberal amount of oil on the short shock shaft and slowly push it into the shock, and pull it all the way to the bottom.

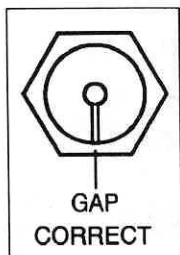


**Fig. 98**

□ **Figs. 95, 96, & 97** Now take the shock body and the installation tool and push the parts slowly into the shock body all the way down until it bottoms out. Then give it a hard push to seat the split washer. You should be able to hear the washer snap into place. Pull the installation tool out. Look into the shock body to check the installation. **IMPORTANT!** The split ring should look like fig. 97. If it looks like fig. 98, then the washer is not seated in the lock groove and the shock will come apart. **MAKE SURE THE WASHER IS FULLY SEATED IN THE GROOVE.** (Note: To remove the parts, take the installation tool, insert it up through the bottom of the shock, and push the split washer out.)



**Fig. 95**



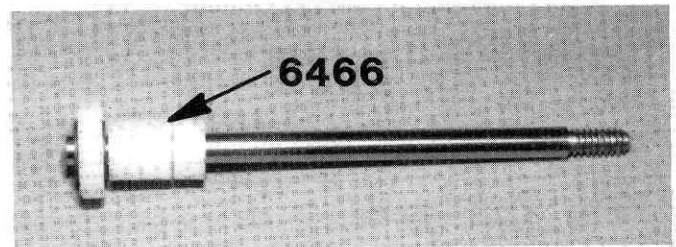
**Fig. 96**



**Fig. 97**

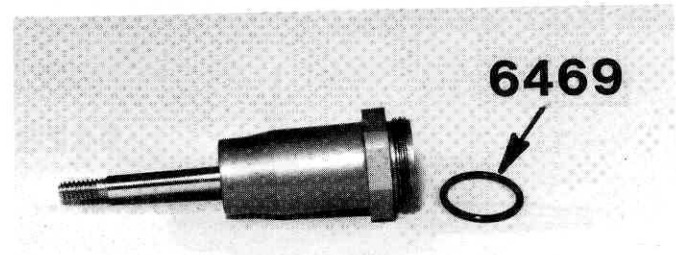
(THESE DRAWINGS ARE NOT ACTUAL SIZE.)

□ **Fig. 99** In bag 6-9 will be six #6466 nylon spacers. Slip three of these onto each of the long shafts, all the way up to the piston. These spacers are not used on the front shocks.



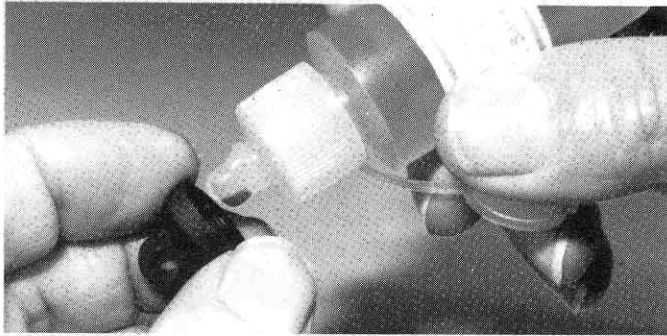
**Fig. 99**

□ **Fig. 100** Slip the #6469 black O-ring over the threads and seat it flush against the pocket at the bottom of the threads.



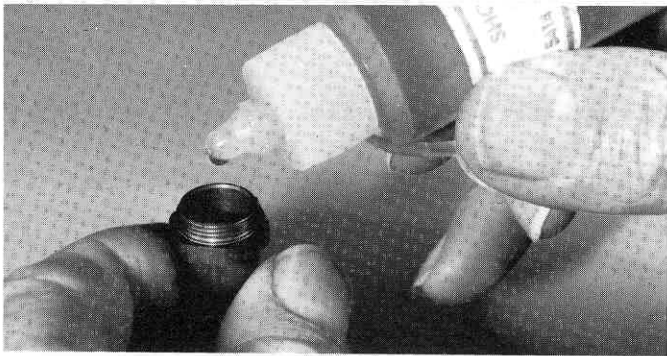
**Fig. 100**

**Fig. 101 IMPORTANT:** Thoroughly lubricate the threads in the #6428 plastic cap **BEFORE** installing. **IT MUST BE LUBRICATED FOR PROPER INSTALLATION.** We'll install it soon.



**Fig. 101**

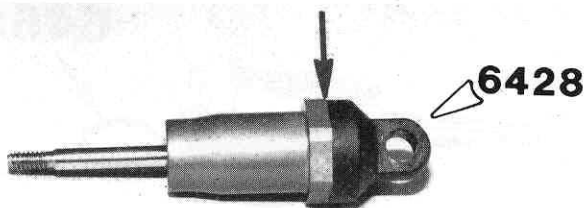
**Fig. 102** Fill the front shocks all the way to the top, but fill the rear shocks only to within 1/16" of the top.



**Fig. 102**

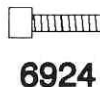
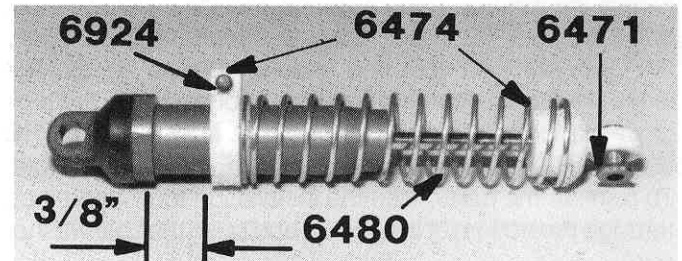
**Fig. 103** Push the shaft up so the piston is up to the top of the body, otherwise there will be too much internal pressure. **VERY CAREFULLY** screw the shock cap onto the body, making sure the cap goes on straight. **BE CAREFUL** not to crossthread the cap.

The cap needs to screw all the way down to the shock body. There should be no gap between the cap and bottom where the arrow is indicating. The O-ring will actually be doing the sealing so we must **BE CAREFUL** not to overtighten the cap and strip out the threads. As soon as the cap comes into contact with the body just turn it a **VERY SMALL** amount to seat it.



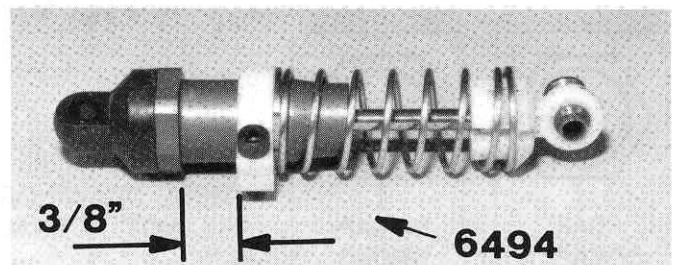
**Fig. 103**

**Fig. 104** From bag #6-11 install two of the #6474 spring clamps on the rear shocks with two #6924 4/40 x 3/8" SHCScrews. The spring clamps have a thin flange on one side. Make sure this is facing the side the spring makes contact with. Install one with the screw head up and the other with the screw head down. There should be a 3/8" space between the collar and the body hex nut. Tighten the screws just enough to lock the collars. **DO NOT** over tighten. Slip on one of the #6480 long green springs. Check your catalog for springs with softer or harder specifications. Our testing has shown these springs to be the best all around spring for almost all off road racing. Now take the #6471 plastic rod end and press it onto the #6471 metal ball end. The easiest way to do this is to set the metal ball end, flat side down, on a table. Place the plastic rod end over the ball and push it in place with a 1/4" nut driver. Now you will want to thread the plastic onto the shock shaft. You will need to keep the shock shaft from rotating by holding it with needlenose pliers. Grab the shaft close to the threads so that you do not scratch the part that rides in the o-rings. **WARNING!** make sure that you grab the shaft with the smooth part of the pliers jaw. Now compress the spring enough so that you can slip the #6474 plastic split spring collar over the plastic rod end and shaft. Press the split spring collar down over the rod end until it seats and then let the spring seat over the collar.



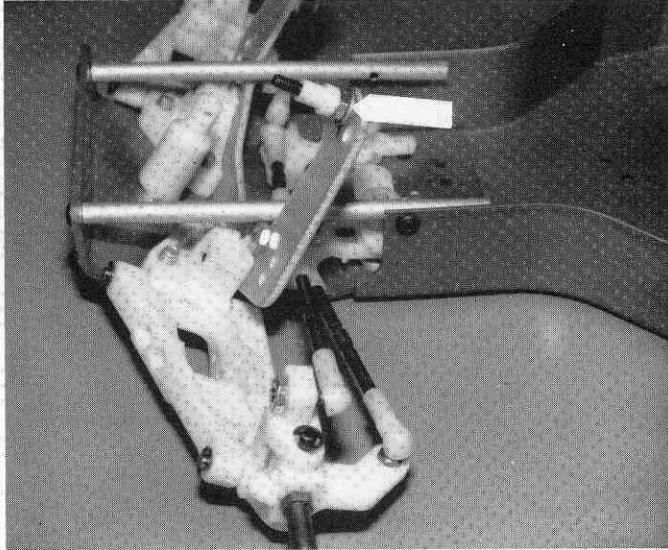
**Fig. 104**

**Fig. 105** Working with the same bag #6-11 we will repeat the above steps for the front shocks. Use the #6494 short green front springs when you get to the point of installing the springs on the shocks. Again your catalog will list additional springs which will allow the driver to try different suspension settings for different track conditions. Set the spacing between the spring clamp collar and the body hex nut at the same 3/8"

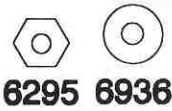


**Fig. 105**

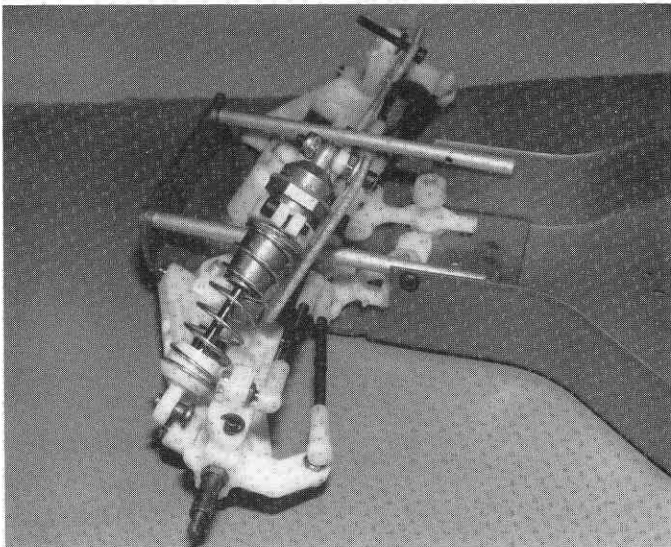
**Fig. 106** Now we'll install the front shocks on the car. The arrow in the photo is pointing to the upper mount. Taking parts from bag 6-10, slip on a #6936 #4 aluminum washer and then screw down and tighten one of the #6295 4/40 plain nuts. The arrow is pointing to the #6473 flanged nylon shock bushing. Slip this bushing on next, with the flanged end on first.



**Fig. 106**



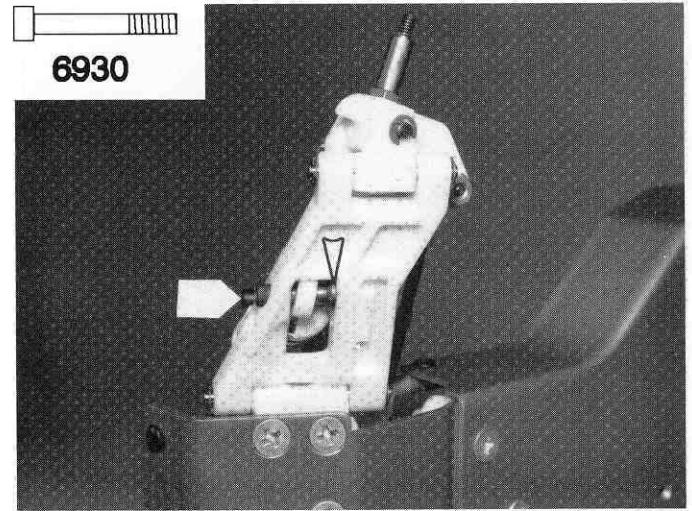
**Fig. 107** Slip the shock on the upper mount and install a #6295 4/40 locking nut. DO NOT tighten down too tight on this nut or you'll bind up the shock. Squeeze the bottom end of the shock up and then slip the end down into the lower "A" arm slot, with the flat side of the ball to the rear.



**Fig. 107**

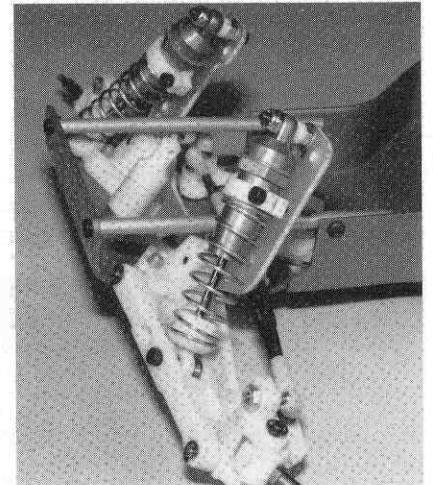


**Fig. 108** The flat side of the ball should be towards the rear as the upper arrow shows. Now, back in Bag #6-1 you have two #6930 4/40 x 3/4" long special shock screws that only have 1/4" of threads. Use these screws to mount the lower shock balls to the "A" arm, as shown. make sure you use outer mounting holes.



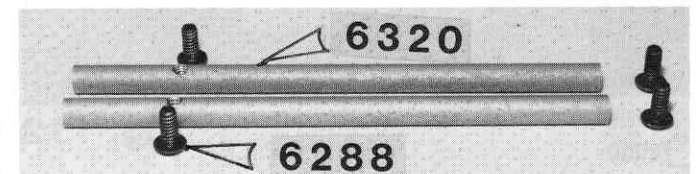
**Fig. 108**

**Fig. 109**  
Install the R.H. shock.



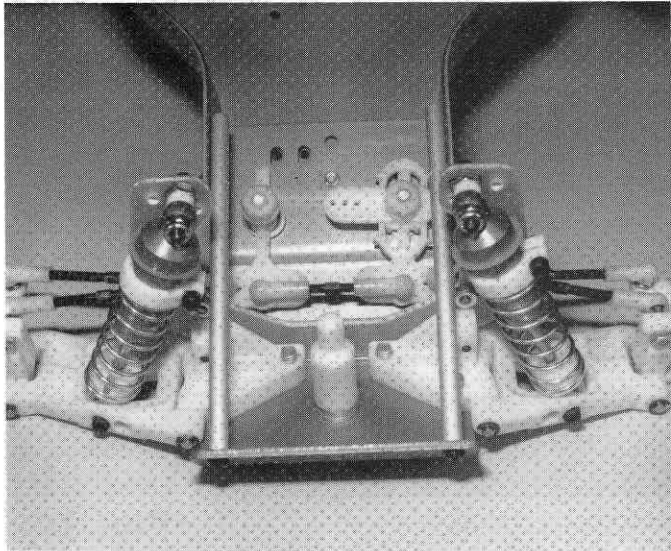
**Fig. 109**

**Fig. 110** In Bag #6-4 are the 2 #6320 nose brace tubes and four #6288 4/40 x 1/4" BHSS Allen button head screws, as shown.



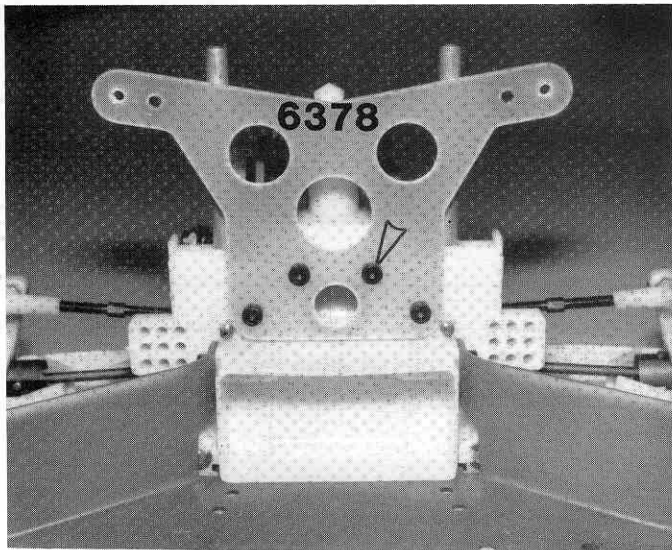
**Fig. 110**

□ **Fig. 111** These tubes tie in the nose piece very solidly to the chassis. Start by installing the rear screw through the side of the chassis, but do not tighten yet. Install the forward screw through the front of the nose piece into the end of the rod and tighten down. Now tighten the rear screw. Install the 2nd brace.



**Fig. 111**

□ **Fig. 112** Also in Bag #6-4 is the #6378 rear shock strut. Assemble this to the rear bulkhead with the four #6932 4/40 x 5/16" SHCS Allen screws, as shown.

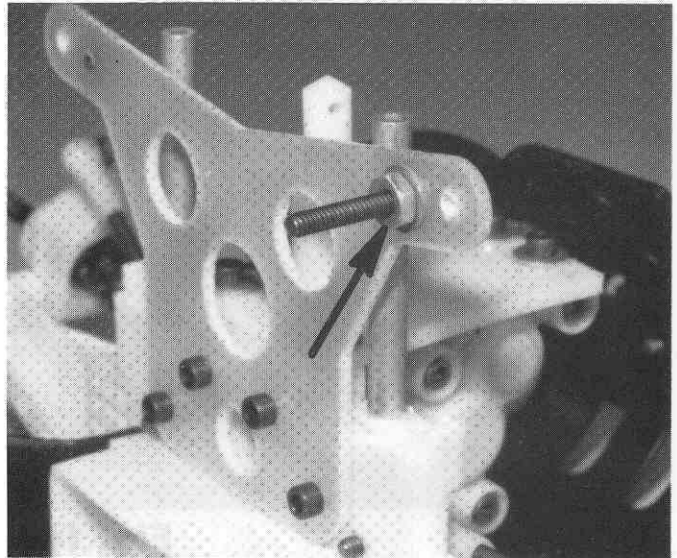


**Fig. 112**



6932

□ **Fig. 113 & 114** It's time to install the rear shocks. From Bag #6-9, install one of the #6927 4/40 x 3/4" SHCScrews through the inner hole of the shock strut. Install it from the rear as shown. Slip on a #4 aluminum flat washer and then thread on a #6295 4/40 plain nut. Slide a #6473 shock bushing onto the bolt with the flange end first. Now slip the shock end over the screw and onto the bushing. Now install the R.H. shock.



**Fig. 113**



6936

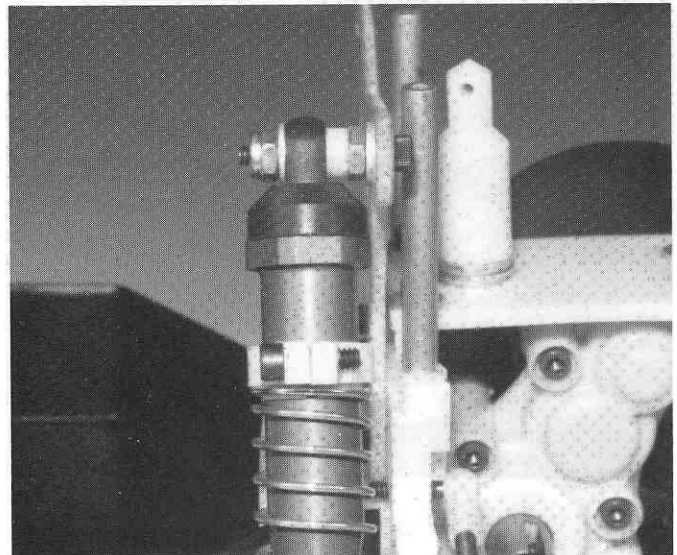


6295



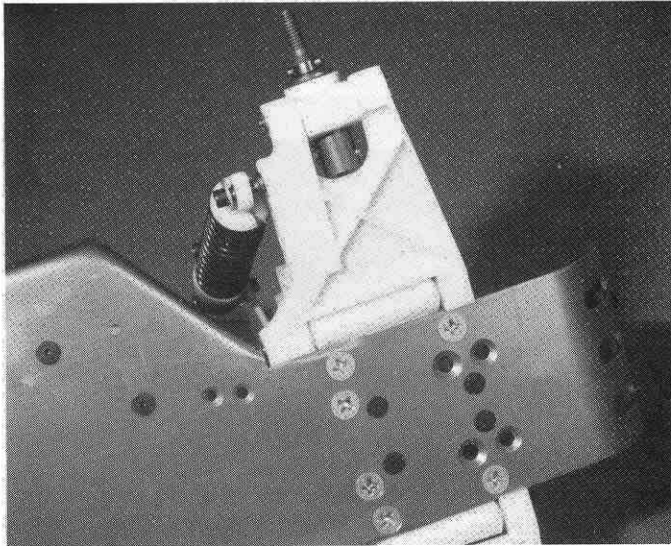
6927

□ **Fig. 114** Install a #6936 #4 washer and a #6295 4/40 nylock locking nut next. Do not overtighten the nut, it is only necessary for the nut to take up the end play. Now do the other shock.

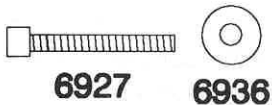


**Fig. 114**

□ **Fig. 115** For the shock bottom installation we want the flat part of the metal ball end to be against the A- arm, as shown. In the A-arm, there are four holes. Install it in the outside hole, as shown. Slip a #6936 #4 flat washer on the #6927 4/40 x 3/4" SHCScrew, and install the screw through ball and into the arm.



**Fig. 115**

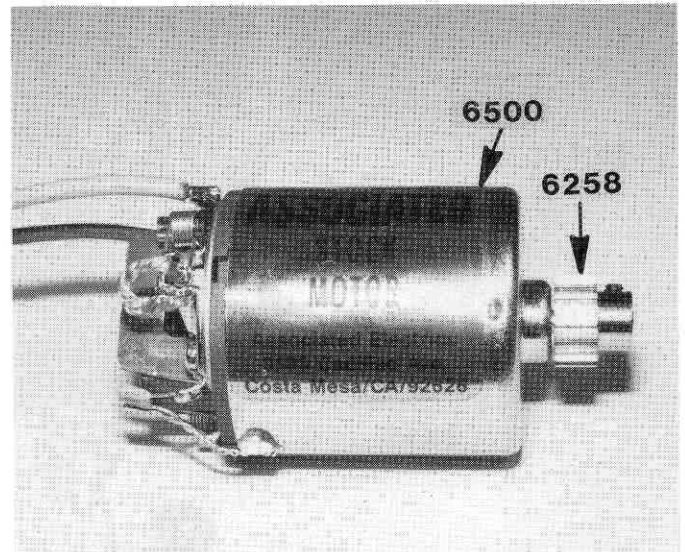


## MOTOR MOUNTING

□ **Fig. 116 & 116a** Time to put the horsepower in the car. Using ROSIN core solder, solder the motor lead wires and filter capacitors to the #6500 stock motor, according to the instructions in the motor bag. From bag #6-15, take the #8258 21 tooth, 48 pitch pinion and install it on the motor shaft as shown. Start with the end of the pinion even with the end of the shaft (Fig. 117a). Remove the plastic gear cover we installed earlier.



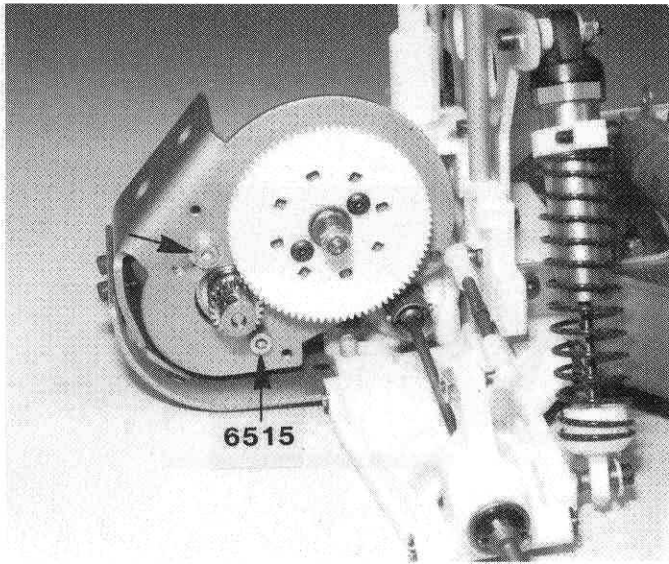
**Fig. 116**



**Fig. 116a**

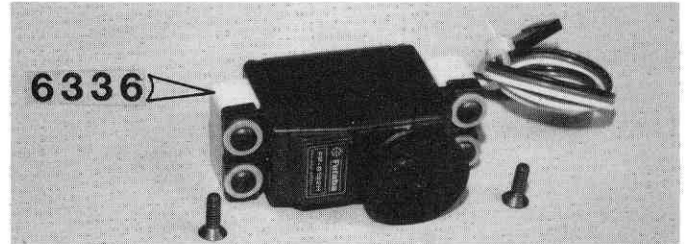
□ **Fig. 117** In the motor bag are two #6515 gold, metric, motor mounting screws. These screws have finer threads, 3mm, and are used **ONLY** to mount the motor. Slip the motor in the motor mount and start the bottom screw in first. Do not tighten all the way down yet. On the top screw, put a #6936 aluminum #4 washer on the screw and screw it in, but not tight. Now we'll set the gear mesh. By moving the upper screw, forward or back, we'll be moving the motor closer to, or away from the plastic spur gear. What we want to do is to get the metal pinion gear as close to the plastic spur gear as we can without binding up the gears. The easy way to check this is to put your finger on the plastic gear and see if you can rock it in the teeth of the metal gear. The two gears should be as close as possible, while still being able to very slightly rock the plastic gear.

When you have this correct spacing, tighten down on the two motor screws and re-check the gear spacing. An incorrect gear mesh can result in a huge power loss, so do it correctly. Now recheck the pinion location and make sure it is centered on the spur gear. If it is off, loosen the pinion set screw, realign, and tighten.

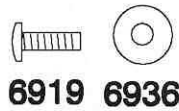


**Fig. 117**

#43 (2.3mm) holes in each mount on the side away from the chassis mounting hole, which will be on the bottom of the mount. You'll notice that the chassis has 2 sets of servo mounting holes. A short set and a long set. With 2 different sets and by rotating the servo mounts 90 deg, you will be able to mount most servos. Attach the servo to the mounts with four #6921 4/40 x 5/16" BHSS Allen screws and #4 flat washers, as shown.



**Fig. 118**



## RADIO INSTALLATION

We're ready to install the radio. If you have not purchased a radio yet, try to stay with a name brand like Futaba or Airtronics. However, many other radios, including stick models, can be used in the car. The higher torque medium sized servos (like the Futaba S128, S148, S131's, 9401, 9301, 9201 or 9101; or Airtronics 94102, 94732, or 94737) are preferred for steering. Small servos like the Futaba's S132's are best for the throttle; but both sizes, small and medium, can be made to work.

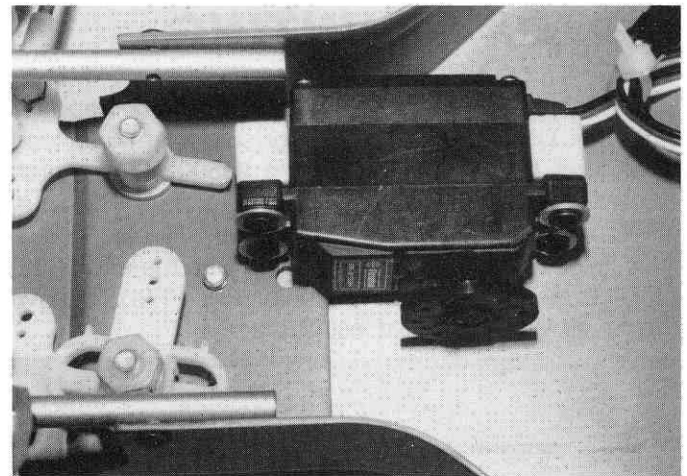
The photos that follow show the installation of a Futaba S132 or S28 servos. Special instructions and photos for medium are also included. In these instructions, servo sizes (the width of the case between the mounting ears but not including the ears) are grouped as follows:

SMALL (S132)	1.5 in. (38mm)
MEDIUM (S131)	1.6 in. (41mm)

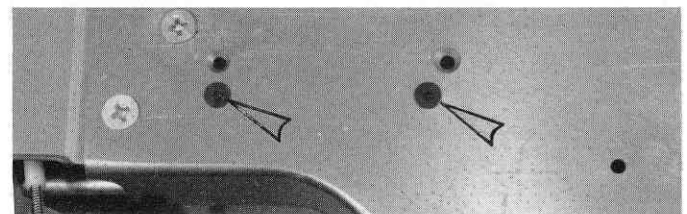
### Special Instructions: Small steering servo

□ **Fig. 118** In Bag #6-6, take out 2 of the #6336 plastic servo mounts. You'll have to drill the mounts for your particular servos. If you have S32 servos, line up your servo with the mounts, so that there will be about 1/16" (1.6mm) clearance between the servo and the chassis plate and mark the hole locations on the mounts. Drill two

□ **Fig. 119 & 120** Install the servo to chassis with the two #6292 4/40 x 3/8 FHSS Allen screws shown in drawing below. You'll have to install two #4 flat washers between the rear mount and chassis for proper alignment. Fig. 121a shows the proper holes to use with small servos.



**Fig. 119**



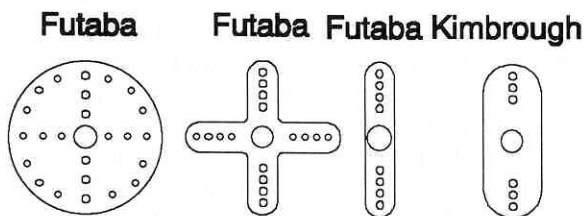
**Fig. 120**



□ **Fig. 121** From bag #6-2, take out the #6256 "Z" bend piano wire linkage and set collars. Locate the servo horn that comes with your radio that looks like a "+" or "-" shape but with a mounting hole in the center. You will need to cut off one or three of the arms on the servo horn depending upon which one you have. Make sure that the one arm of the horn that you are leaving is the longer one. (The round servo horn is not recommended.)

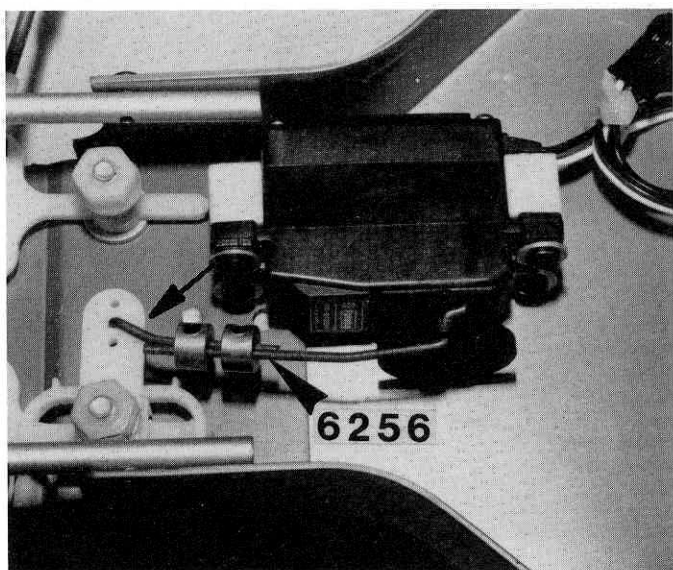
You will now want to install this horn on the servo. Turn the servo horn to the left and right stops making sure that you have equal travel on both sides. It will not be exact, but it will be close enough for now. We'll center it exactly with the radio later.

Now slip one of the "Z" bend rods into the upper hole of the servo horn arm. Install the other "Z" bend rod in the servo saver arm as shown. The "Z" bend will be easier to install in the servo saver arm if you take your X-acto knife and rotate it in the hole to bevel it slightly. The arrow in the photo is pointing to the slight bend that we want to put in the wire so the collars will clear the servo. Put a slight bend in the rod and then install it into the servo saver arm, as shown. Center the servo saver and vertically center the servo horn then install and tighten both locking collars. **NOTE:** It may be necessary to cut the "Z" bend rods to prevent any binding.



**TYPES OF SERVO HORNS**

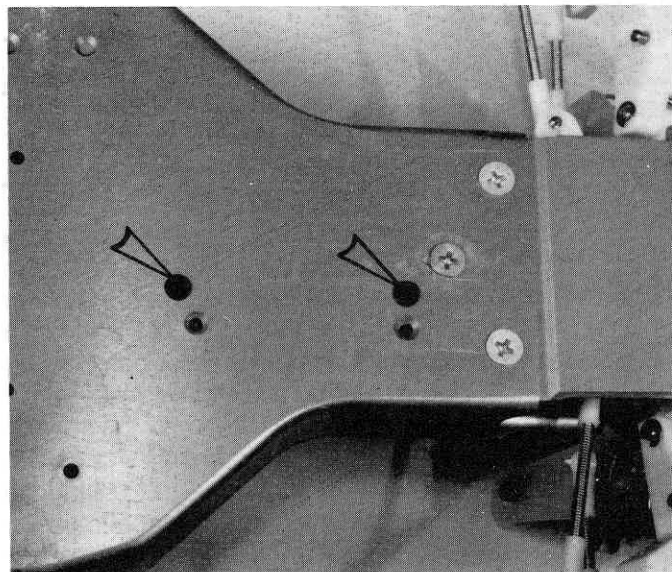
(THESE DRAWINGS ARE NOT ACTUAL SIZE.)



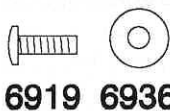
**Fig. 121**

**Special Instructions: Medium steering servo**

□ **Fig. 122** Page 35 lists the medium-sized servos, along with Novak NES1A. Follow the same procedure for the small servo but use the wider-spaced mounting holes in the chassis. Again, the round servo horns are no longer used for the steering servo.

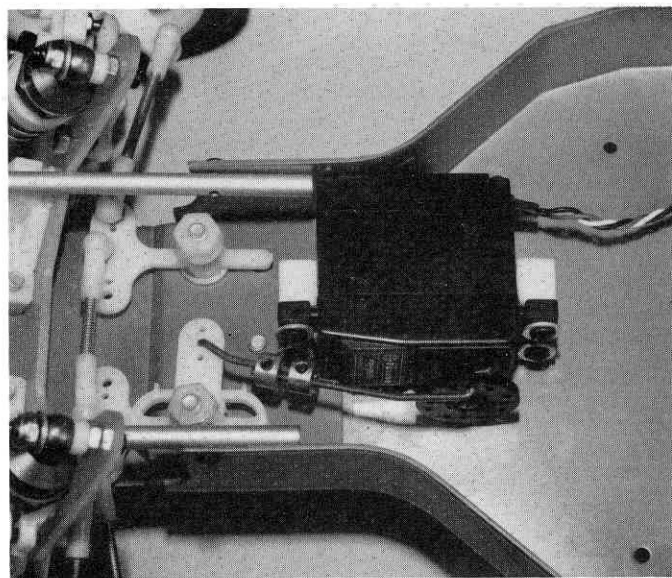


**Fig. 122**



6919 6936

□ **Fig. 123** Linkage is the same as for small servo but may require slightly more bend.



**Fig. 123**

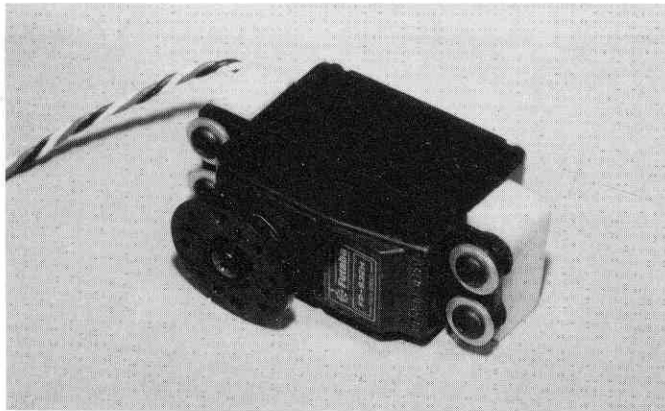


6292

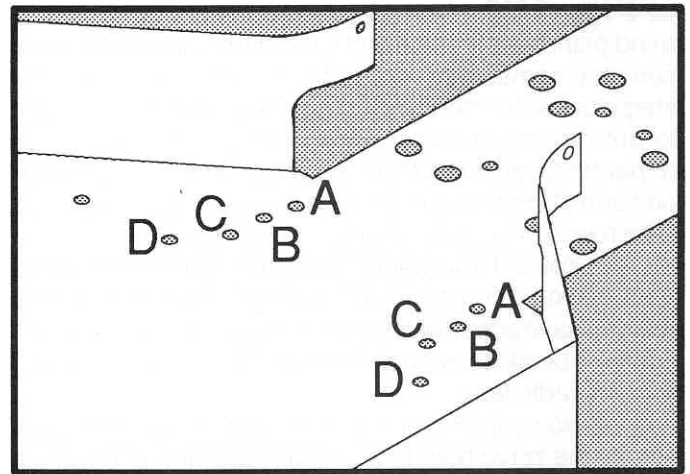
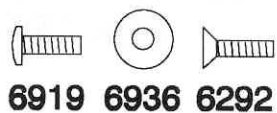
## THROTTLE SERVO

Because of the great variety of servo sizes and manufacturers now available, the following installation instructions are meant as a guideline. New pre-bent resistor brackets are designed to fit as many servos as possible. **NOTE:** Airtronics small servos are not recommended for use as a throttle servo. Later are written installation instructions for both Futaba and Airtronics medium sized servos, and instructions for installing small Futaba servo sizes.

□ **Fig. 124 & 124a** Fig. 129a shows the three sets of mounting holes that are used for mounting the resistor and various manufacturers servos. Each set of holes are labeled to simplify the instructions. For Futaba small servos (servo shown is a Futaba S32) from bag #6-5 take two #6292 4/40 x 3/8" FHSS and two servo mounting blocks and mount the blocks to the chassis using the mounting holes marked "A". The servo block mounting holes should be to the back putting more of the block in front of the mounting screw. Place the servo between the mounting blocks. It should fit between with just a little pressure. Push the servo down until the top of the servo is level with the top of the mounting blocks. This should give you enough clearance to prevent the wiper (still to be installed) from touching the chassis. The servo must be installed with the output shaft on the right or passenger side of the car (left side in photos). Mark the servo blocks for the center point of each mounting hole. Remove the servo mounting blocks and drill each mounting location with a #43 drill bit (a 3/32" drill bit will work but keep it very steady when you drill). Now mount the blocks to the servo using four #6919 4/40 x 5/16" BHSS and four #6936 #4 aluminum washers. Make sure that the chassis to servo block mounting hole is to the back of the servo.



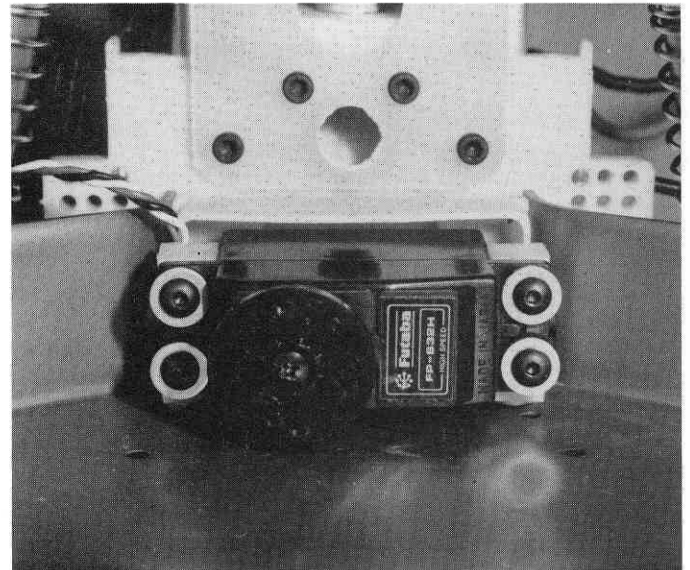
**Fig. 124**



(DRAWING NOT ACTUAL SIZE.)

**Fig. 124a**

□ **Fig. 125** If your servo comes with a small round servo horn this will be the best choice for this installation. If not, you will have to modify, as necessary, the servo horn that comes with your radio so the servo horn can rotate freely thru its arc. Install the round servo horn on your servo. Install the servo and blocks to the chassis on the "A" mounting holes, as shown, using the same two #6292 4/40 x 3/8" FHSS fasteners we used earlier. It is important that the servo mount high enough to allow the servo wheel to clear the chassis by about 1/8" (3.1mm). Add washers under the mounts if necessary to give the required clearance.

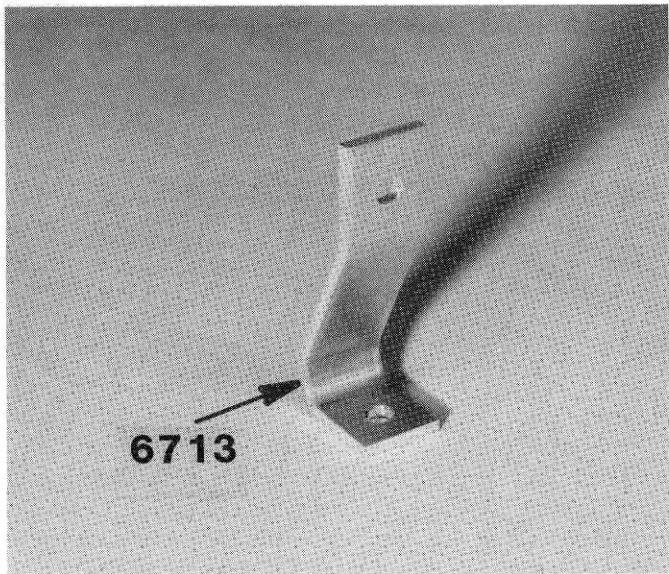


**Fig. 125**

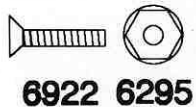




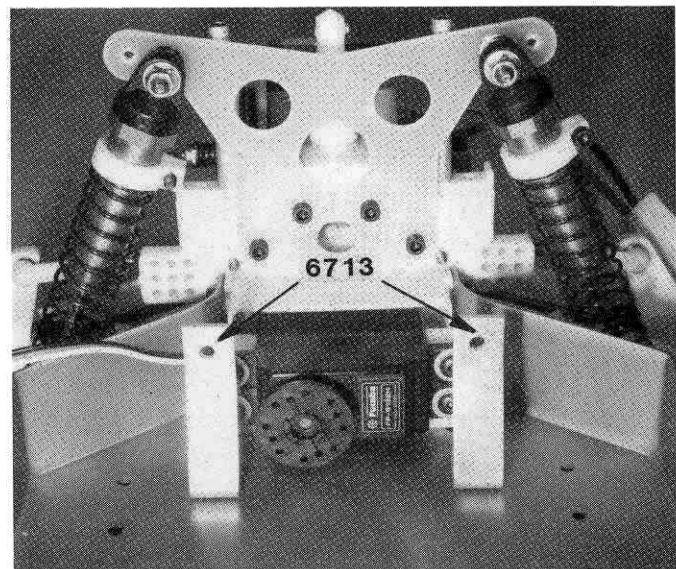
□ **Fig. 126 & 126a** From Bag #6-13, install the two #6713 bent resistor mounting brackets to the "C" holes of the chassis with two #6922 4/40 x 1/2" FHSS and two #6295 locknuts as shown. Make sure that the angles in the brackets are facing towards the back of the car. The lower bend will be towards the front of the car. The upper portion of the brackets should also be close to vertical, if not, bend to correct.



**Fig. 126**



6922 6295

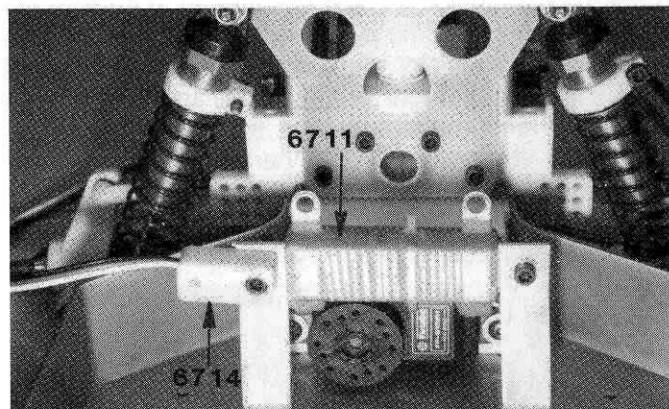


**Fig. 126a**

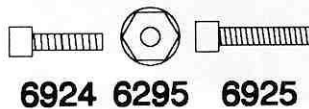
□ **Fig. 127** Slip the flat aluminum mounting bar through the #6711 resistor, both from bag #6-13. Install the resistor mounting bar on the back side of the brackets (closer to the rear bulkhead). The drivers side (right side in photo) of resistor mount will be secured using a #6924 4/40 x 3/8" SHCS and a #6295 4/40 locknut. On the passenger side (left side of photo) install the #6714 plastic bypass mount with the #6925 4/40 x 1/2" SHCS and #6295 4/40 locknut. There are two plastic bypass mounts. Use the mount with the round corners (may be yellow colored) for this servo setup.

Page 44 shows a detailed drawing and a photo on the wiring installation. That page helps clarify each step or part as necessary, so turn to it often for the next steps.

**WARNING:** Use only Rosin core solder for all of the following electrical connections.



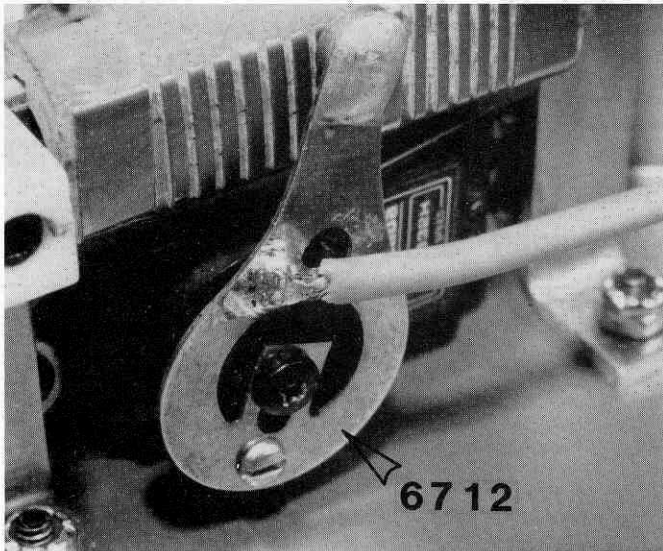
**Fig. 127**



6924 6295 6925

□ **Fig. 128** Center the servo output arm (or horn), as before, then turn it about 30 degrees to the right, or drivers side, of the photo. Locate the #6712 wiper arm (in bag #6-13) so that it is in the exact location shown and note the closest holes in the servo arm/horn to this location. Mount the wiper arm to these holes using the servo arm mounting screw (for the center) and the small #2 self tapping screw and #2 flat washer on the bottom. These are in bag #6-13. Solder the red wire from the #6745 motor output plug to the wiper arm in the location shown in the photo. NOTE: If your servo arm or horn has a raised center then use the extra #2 flat washer between the wiper arm and servo arm/horn to stand the wiper off from the edge of the servo arm. Install the servo arm/horn and wiper arm onto the servo output shaft and secure with the servo arm/horn screw.

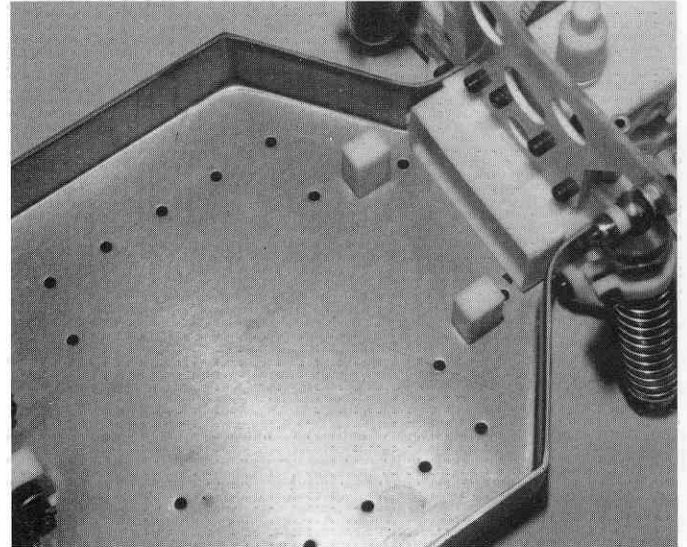
This next item is **VERY IMPORTANT**. The wiper arm brass button must push quite firmly against the resistor in order to make good contact. If it does not have enough pressure the motor will not operate to its fullest horsepower and you will burn out the resistor. An easy way to check this is to take the fingernail of your smallest finger and lift the button a very small amount off the resistor. If it lifts off quite easily, its too soft. It should pull quite hard on your fingernail, BEFORE it lifts off - then it's correct. You can adjust the resistor mounting brackets for this or you can bend the wiper arm if necessary to achieve the correct tension.



**Fig. 128**

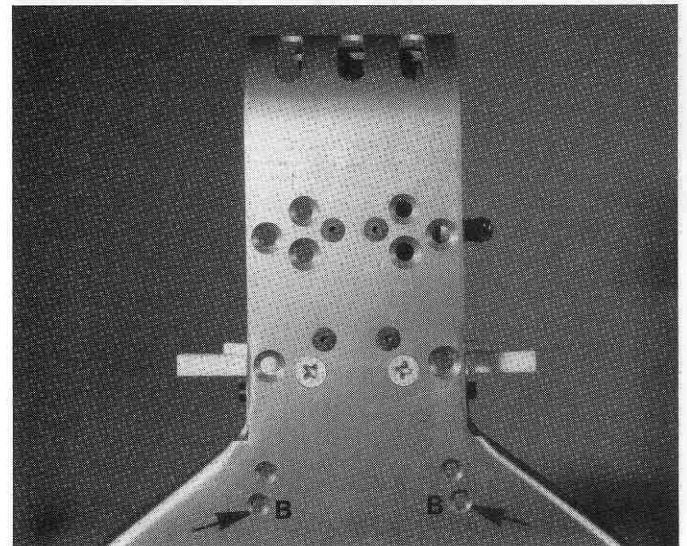
## Special Instructions: Medium throttle servo

□ **Fig. 129 & 130** See the beginning of radio installation section for a description of servo sizes (page 36). Do the following steps to mount a medium sized Futaba or Airtronics throttle servo. From bag #6-5 take two #6292 4/40 x 3/8" FHSScrews, and two plastic servo mounting blocks. Install the servo mounting blocks to the chassis using the "B" chassis mounting holes as in Fig. 130. The servo mounting blocks must be mounted with the chassis mounting hole to the back and the large section of the block to the front.



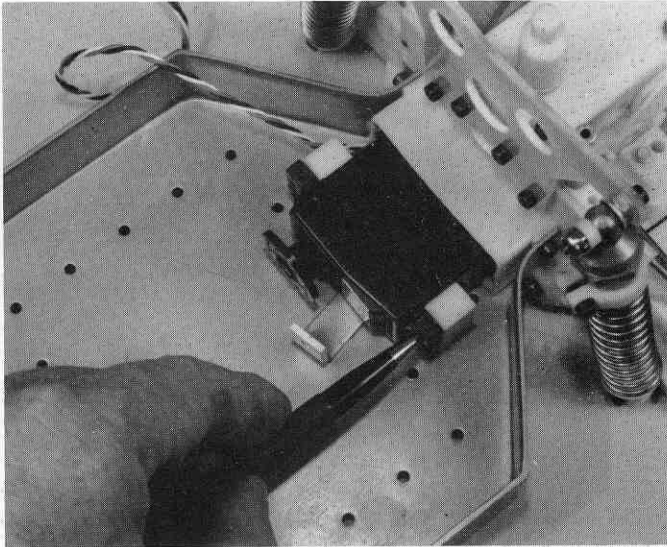
**Fig. 129**

□ **Fig. 130** Use the "B" holes, as marked in photo, to mount medium size servo.



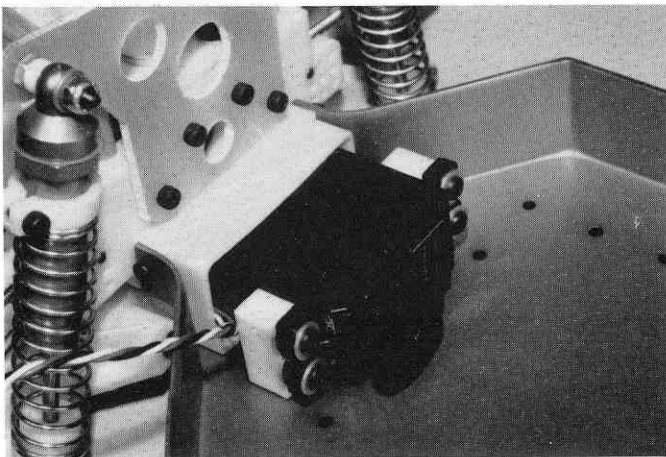
**Fig. 130**

□ **Fig. 131** Drop in the servo and space it off the chassis using the #6711 resistor flat mounting bar (from bag #6-13). Be careful not to damage the servo wires, they can be snug in the bulkhead. Mark the servo mounts with a pencil or fine point marking pen. Remove the servo mounts from the chassis then drill and install the mounts as per instructions in fig. 124. **NOTE:** Make sure the servo is turned so that the output shaft is on the correct side (left side of photo).



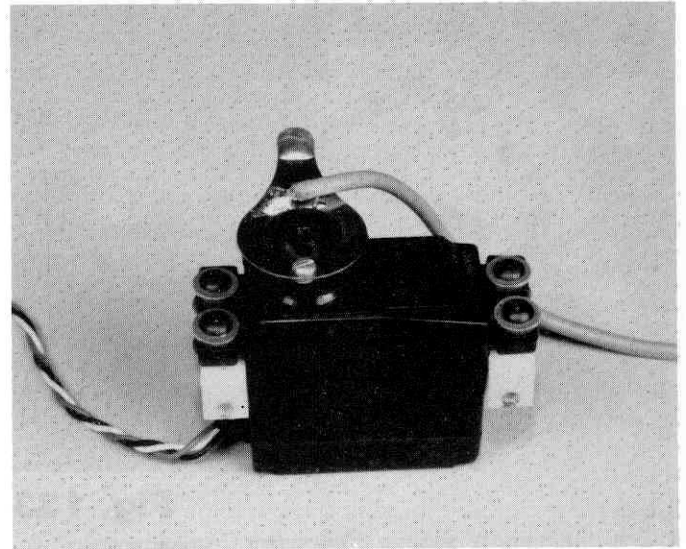
**Fig. 131**

□ **Fig. 132** Reinstall the servo to the chassis, using the same #6292 4/40 x 3/8" fasteners used earlier, on the "B" mounting holes as shown in fig. 130. It is important that the servo horn and wiper clear the chassis by about 1/8" (3.1mm). This will prevent any possibility of the wiper hitting the chassis and grounding the battery to the chassis. Also some servos (the Futaba S28/S128 for instance) are very deep and may bottom out against the back of the bulkhead, making alignment with chassis holes difficult. In this case you should put washers between the mounts and the servo to space the servo away from the bulkhead.



**Fig. 132**

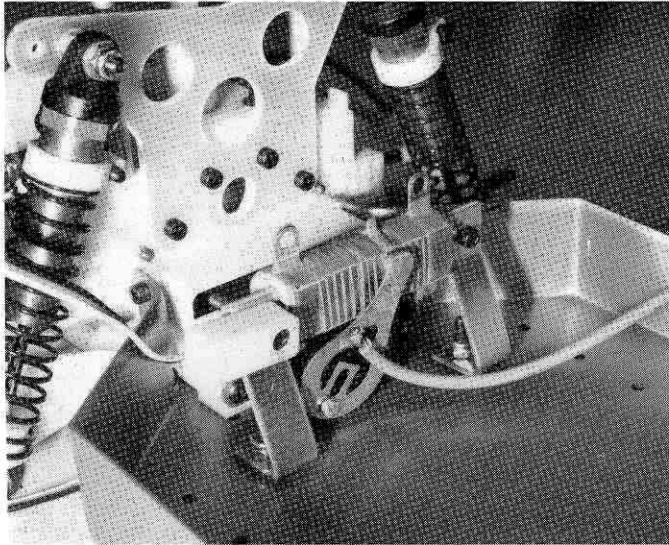
□ **Fig. 133** Follow the first part of instructions for step 128 to determine the mounting position for the wiper arm and soldering the wires. It may be easier to remove the servo from the chassis to mount and solder the wiper arm and then reinstall the servo to the chassis.



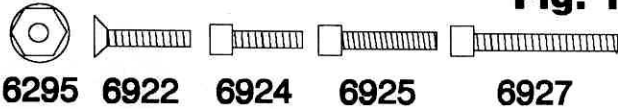
**Fig. 133**

□ **Fig. 134** The setup for Futaba and Airtronics servos varies somewhat. From bag #6-13 take two #6922 4/40 x 1/2" FHSScrews and two #6295 4/40 locknuts and mount the two #6713 bent resistor mounting brackets. Make sure that the angles in the brackets are facing towards the back of the car. The lower bend will be towards the front of the car. Be sure to use the "C" holes of the chassis as shown in fig. 124a. Make sure that the upper portion of the brackets are close to vertical, if not, bend as necessary to correct the problem. **FUTABA SERVO:** Slide the flat aluminum mounting bar through the #6711 resistor (all from bag #6-13) and install the resistor and bar in front of the brackets, as shown in photo. The drivers side of the resistor (right side in photo) will mount using one #6924 4/40 x 3/8" SHCScrew and one #6295 4/40 locknut. On the passenger side of resistor (left side of photo) Install the #6711 thick plastic bypass mount (white with square edges) using one #6927 4/40 x 3/4" SHCScrew and one #6295 4/40 locknut. When assembled, check for proper wiper pressure as in step 128. If the wiper pressure is wrong, it may be necessary to adjust the resistor mounting brackets to correct the problem. **AIRTRONICS SERVO:** Slide the flat aluminum mounting bar through the #6711 resistor. Now mount the resistor and bar on the back side of the brackets. The drivers side of the resistor (right side of photo) will mount using one #6924 4/40 x 3/8" SHCScrew and one #6295 4/40 locknut. Install the passenger side of the resistor (left side of photo) using the thin plastic bypass mount (yellow colored with round corners), one #6925 4/40 x 1/2" SHCScrew and one

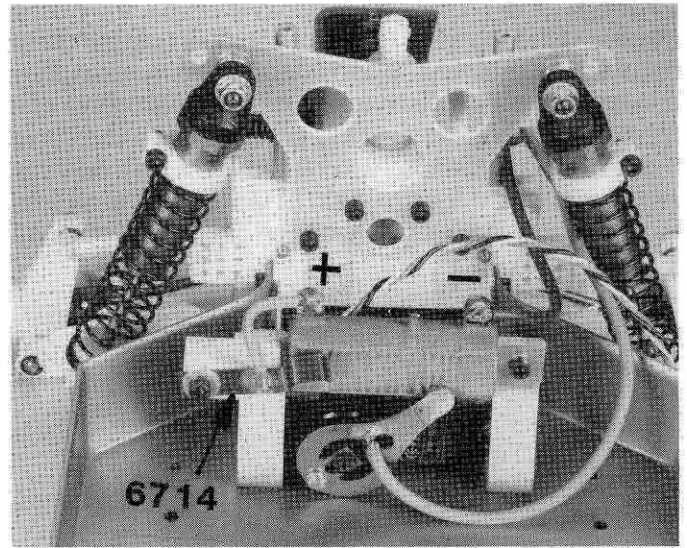
#6295 4/40 locknut. The rest of the the installation will be the same as for a Futaba servo as explained earlier in this step.



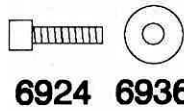
**Fig. 133**



**6295 6922 6924 6925 6927**



**Fig. 135**



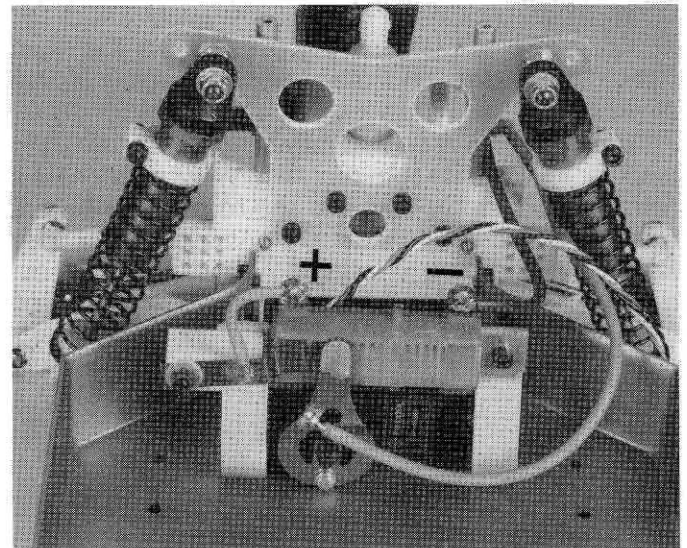
**6924 6936**

## FINAL RADIO ADJUSTMENT AND WIRING

**Fig. 135** From bag #6-13 take the #6714 brass bypass tab and install it to the #6714 plastic bypass mount using a #6924 4/40 x 3/8" SHCScrew and a #6936 aluminum flat washer. Align the indented portion of the bypass tab right in the center of the wide bank of the resistor. Solder a small piece of red 16 guage wire, from bag #6-13, one end to the positive terminal of the #6711 green throttle resistor (left side of photo) and the other end to the #6714 brass bypass tab as shown. Now solder the black wire from the #6745 motor output plug to the negative terminal (right side of photo) on the #6711 throttle resistor.

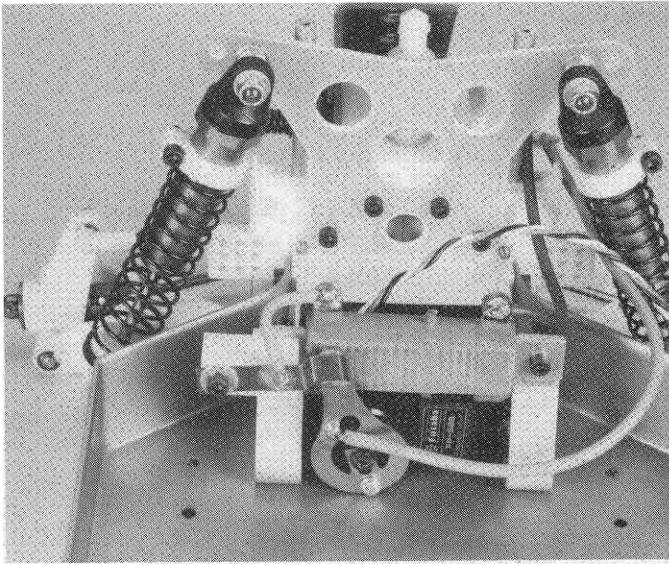
This photo shows the wiper arm just entering the brake band portion of the throttle resistor. (right side of photo). The neutral position is the wider band just to the right of center on the #6711 resistor. In order to make adjusting of the throttle easier set your radio trigger servo trim adjustment for 70/30 (all top brand radios designed for cars have this feature).

**Fig. 136** This is the position that the wiper arm is in at 1/2 throttle. These are the power bands on the resistor.



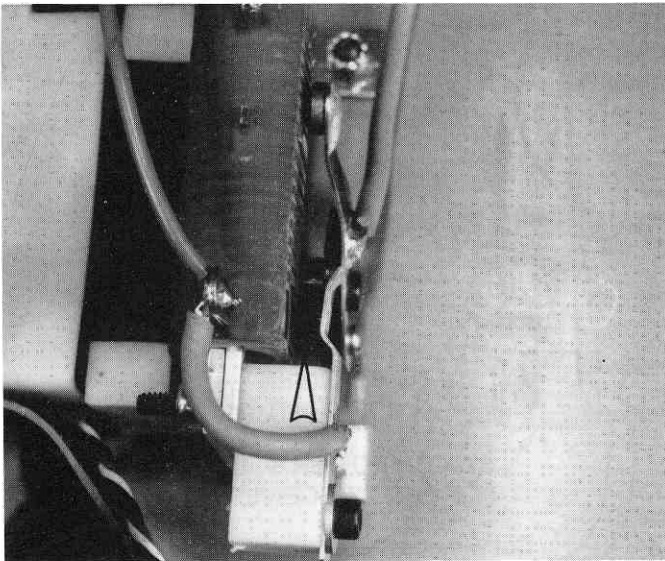
**Fig. 136**

□ **Fig. 137** This is the full power position of the wiper arm. It should be directly behind the bypass button and in the center of the wide band on the resistor.



**Fig. 137**

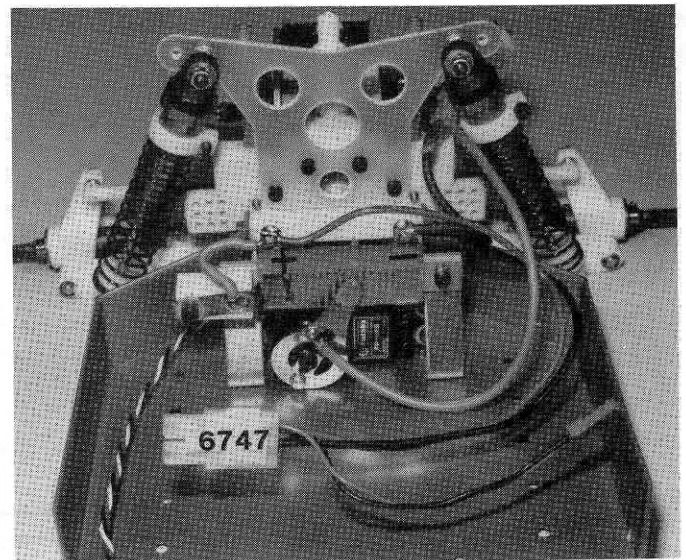
□ **Fig. 138** The arrow is pointing to the space between the bypass button and the resistor band. This distance should be about .025 (.65mm) less than the thickness of the wiper button section, so that when the wiper arm button moves to full throttle it makes the bypass arm move about .025 (.65mm) forward. This bypass arm then helps to increase the pressure on the throttle wiper arm button, thereby giving it an excellent electrical connection. This, of course, allows the motor to achieve full horsepower and helps the resistor to last longer.



**Fig. 138**

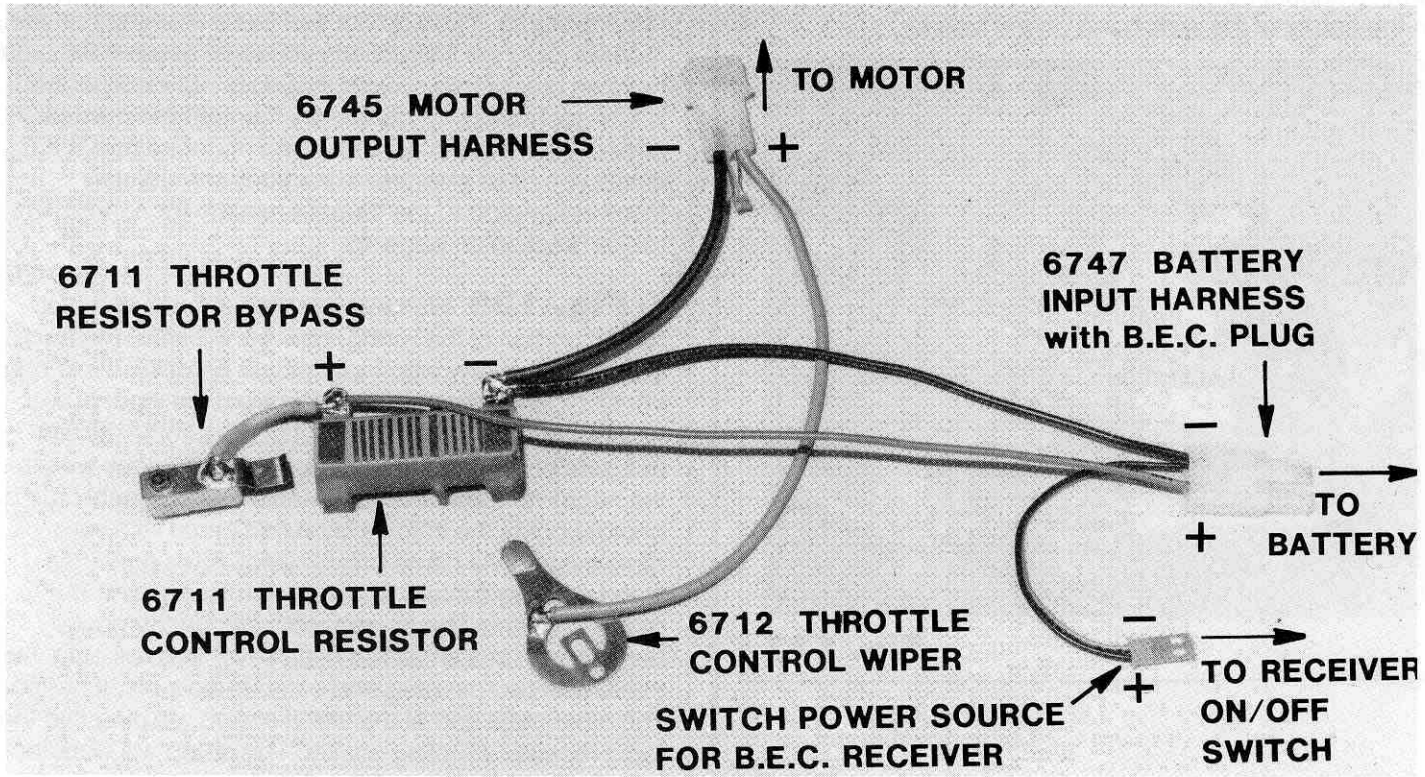
**WARNING:** The current radio instructions are for the newer B.E.C. (battery eliminator circuitry) type radio systems. If you do not see these markings on the receiver or in the instructions you must assume that you have an older radio system that does not incorporate B.E.C. technology. If necessary, contact the manufacturer of your system and ask them. In these non-B.E.C. cases you must skip the instructions immediately following and go to the "Supplementary for non-B.E.C. radios" section on page 45.

□ **Fig. 139** We have installed the #6745 motor output portion of the wiring, now we will finish installing the #6747 battery/radio input power harness. It's in bag #6-13. Solder the larger red wire from the input power harness to the positive terminal of the throttle resistor (left side of photo), then solder the larger black wire to the negative terminal of the throttle resistor (right side of photo) Locate the on/off switch that came with your radio system. All name brand radios have gone to a standard plug system for the switch harness on B.E.C. radios. The small black and red wires on the power harness end in a small red male plug. This will plug into the female two pin plug end of the radio's on/off switch. The other male end of the on/off switch will plug into the radio receiver's battery socket. This setup will work for both 6 cell (7.2 volt) and 7 cell (8.4 volt) battery packs.

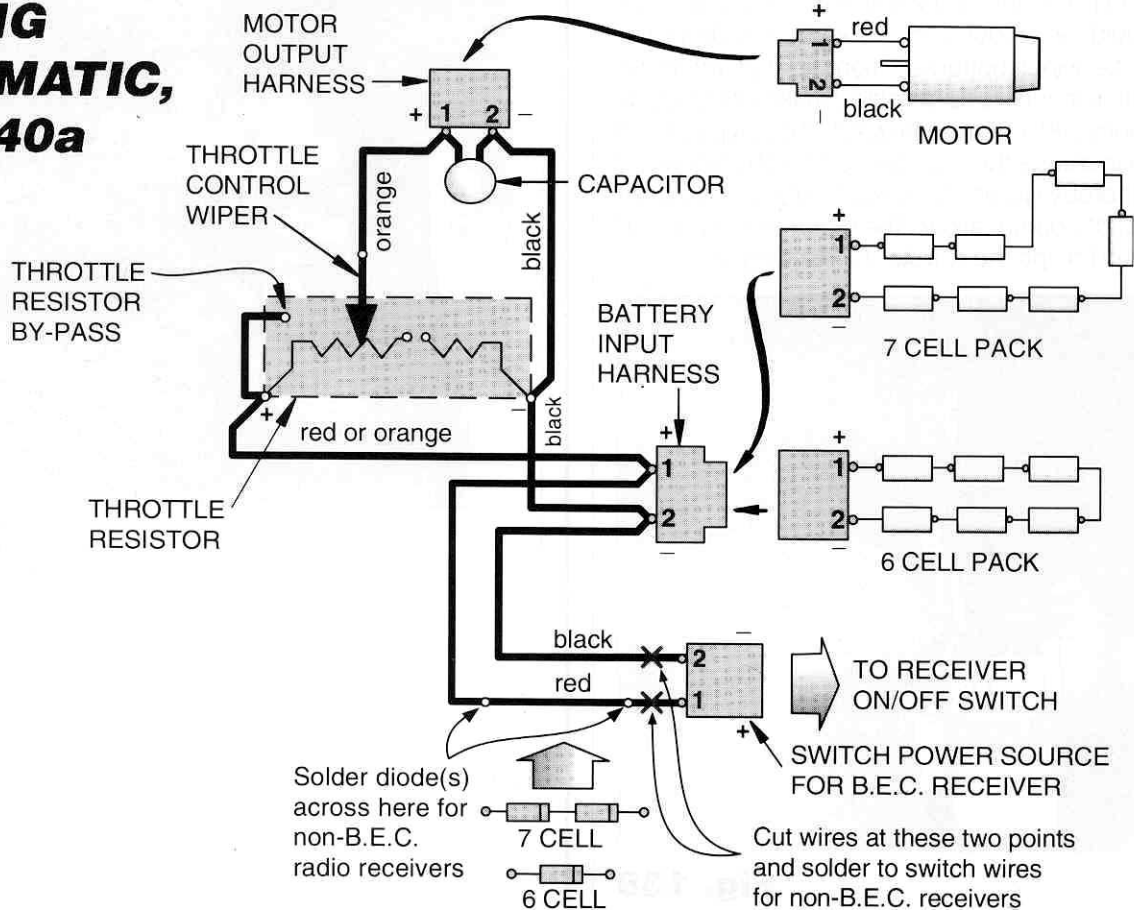


**Fig. 139**

# WIRING DIAGRAM, Fig. 140



# WIRING SCHEMATIC, Fig. 140a



### Supplementary for non-B.E.C. radios

For radios which do not have B.E.C. receivers, the voltage coming direct from a 7.2 or 8.4 volt battery is too high and would damage the receiver. In order to use the battery pack as a power source for the receiver you will have to reduce the voltage from the battery pack to the receiver. We have included two diodes which will allow you to do this.

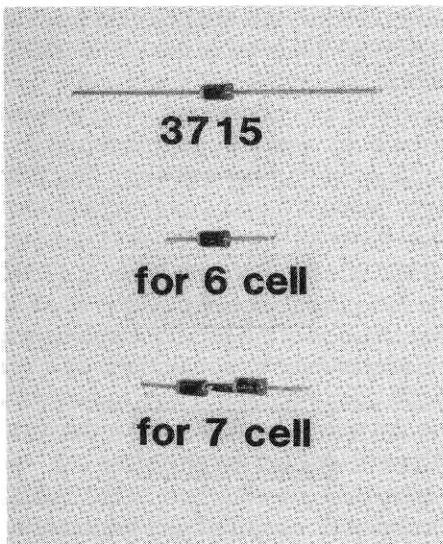
Now you must decide if you are going to run 6 cell or 7 cell battery packs because they will be wired differently. In bag #6-13 you will find a small plastic bag containing two #3715 diodes (see Fig. ). If you are going to be running **6 cell (7.2 volt) batteries** you will only need one diode. Cut the leads on the diode so that there is only 3/8" remaining on each lead. With a **7 cell (8.4 volt) battery** you would use both diodes and cut both of them the same length on the leads. For **either type of battery** you will need to cut off the red plug from the small wires and the battery pack/plug from the on/off switch harness. See wiring schematic, fig. 140a.

**CAUTION!** Make sure that you do not cut off the receiver plug side of the switch harness. A safe way to make sure is to plug the switch harness into the battery plug slot of your receiver before you cut the other end off.

Now cut off the small red plug from the #6747 input power harness (fig. 140a). For a **6 cell battery** you will solder the diode to the small red wire of the input harness. Be certain that the stripe on the diode is on the switch side, not the battery plug side. For a **7 cell battery** you will solder the diode as you did for a 6 cell but you will solder another diode to the first one with the stripe on the switch side. See fig. 140b.

Now that both diodes are soldered to the harness, you can solder the red positive wire from the switch to the end diode on the red wire from the input harness.

□ **Fig. 140b** Now solder black wire from switch to black wire from input harness. Check each of your solder connections and then tape up the solder joints and diodes so that they cannot short out on the chassis. (NOTE: If you can get some small shrink tubing, this will make for a cleaner-looking finished part.)

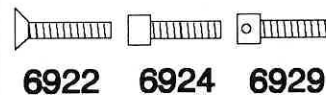
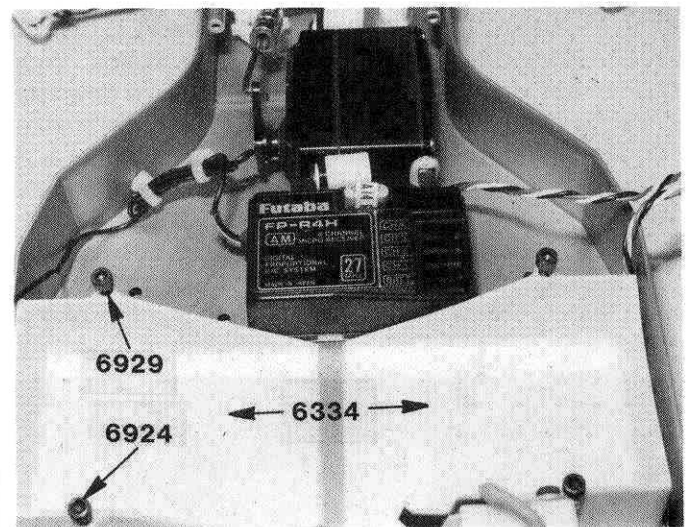


**Fig. 140b**

□ **Fig. 141** Open bag #6-7 and install the two #6334 battery trays to the chassis using four #6922 4/40 x 1/2" FHSScrews from the same bag. There are several sets of holes along each side of the chassis but you will only find four holes that are countersunk and will match up with the battery trays. In the same bag you will find two #6924 4/40 x 3/8" SHCScrews and two special #6929 4/40 x 3/8" SHCScrews with a hole cross-drilled through the head. The standard 4/40 x 3/8" SHCScrews will go in the holes on the battery trays closer to the transmission (or back of the car) while the special 4/40 x 3/8" SHCScrew (with the drilled hole) will be mounted in the two forward holes in the battery trays, where the arrow is pointing (see fig. 142). Do not tighten the screws all the way down. Leave them up about .065" (1.65mm).

Then in the two rear holes install the standard 4/40 x 3/8" SHCScrews, leaving them up about .085" (2.15mm). Now attach the on/off switch to the side of the chassis.

There is enough room for you to mount your receiver between the steering servo and the battery trays as shown. If you have either a large servo or receiver you can mount the receiver on its side in the same location.



**Fig. 141**