

Track Condition

- Composition: Asphalt Carpet
 Surface: Smooth Medium Bumpy
 Traction: Low Medium High
 Size: Tight Medium Open
 Track Temp.: _____ Air Temp.: _____

Electronics

- Motor: _____ Timing: _____
 ESC: _____ Battery: _____
 Spur: _____ Pinion: _____ Final Ratio: _____

Aerodynamics

- Body: _____ Wing: _____

- | | | |
|--------------|-----------------------|-------------|
| Front | Shocks | Rear |
| _____ | - Spring - _____ | _____ |
| _____ | - Oil - _____ | _____ |
| _____ | - Piston - _____ | _____ |
| _____ | - Rebound (%) - _____ | _____ |

Anti-Roll Bar

- Tires**
- _____ - Inserts - _____
 _____ - Rims - _____
 _____ - Additive - _____
 _____ - Additive Time - _____

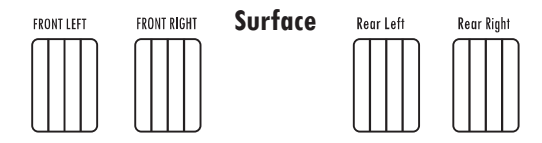

Transmission

- _____ - Oil - _____
 _____ - Oil Weight (Grs) - _____
 _____ - Setting - _____

Spool

Roll Center

- _____ - Setting - _____

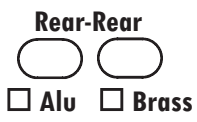
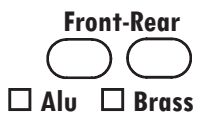
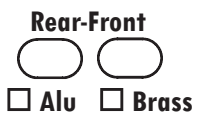
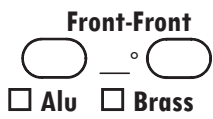

Inserts

- (2.5 2) (3 1.5) (3.5 1)

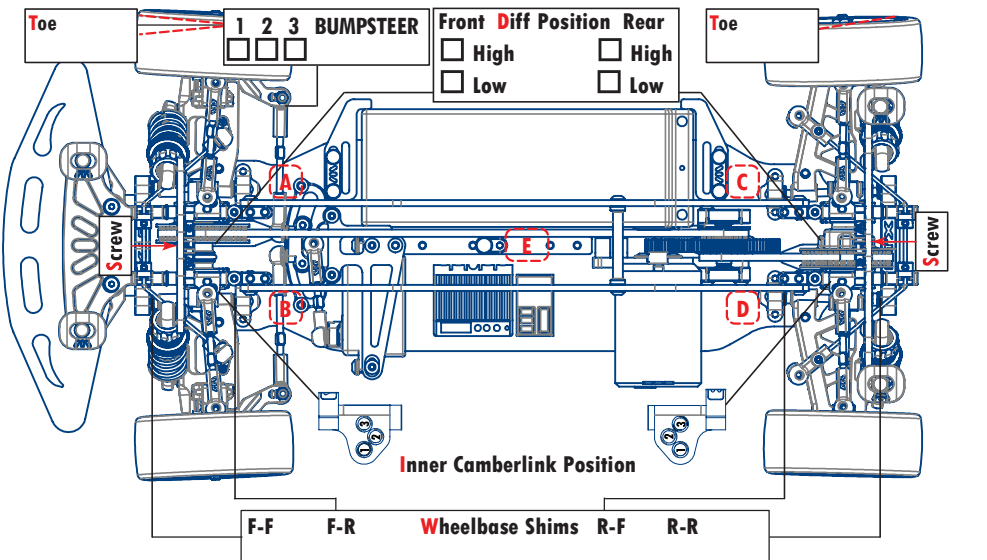
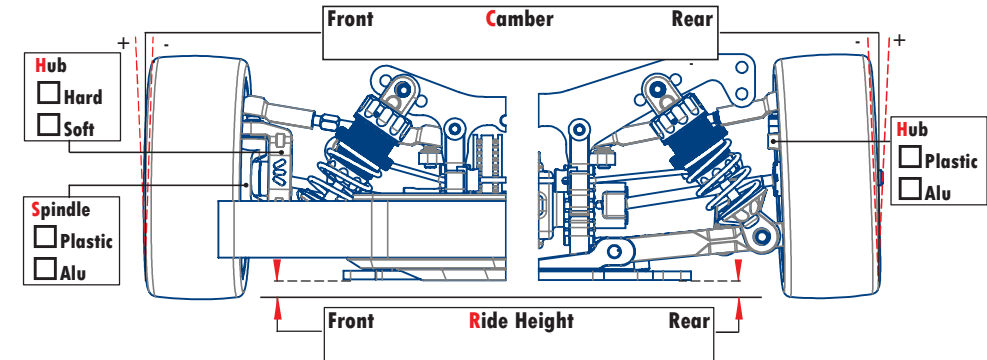
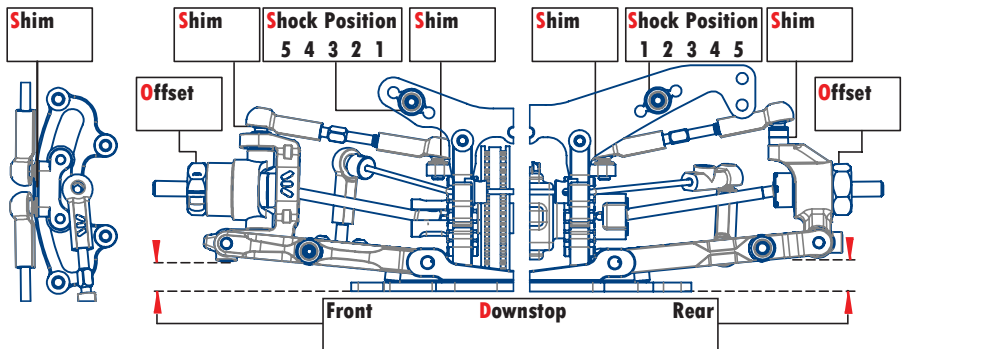

Balance Weight (Grs) - A: _____ B: _____ C: _____ D: _____ E: _____

Total Car Weight (Grs): _____



Notes