

セッティング記録 / SETUP RECORD

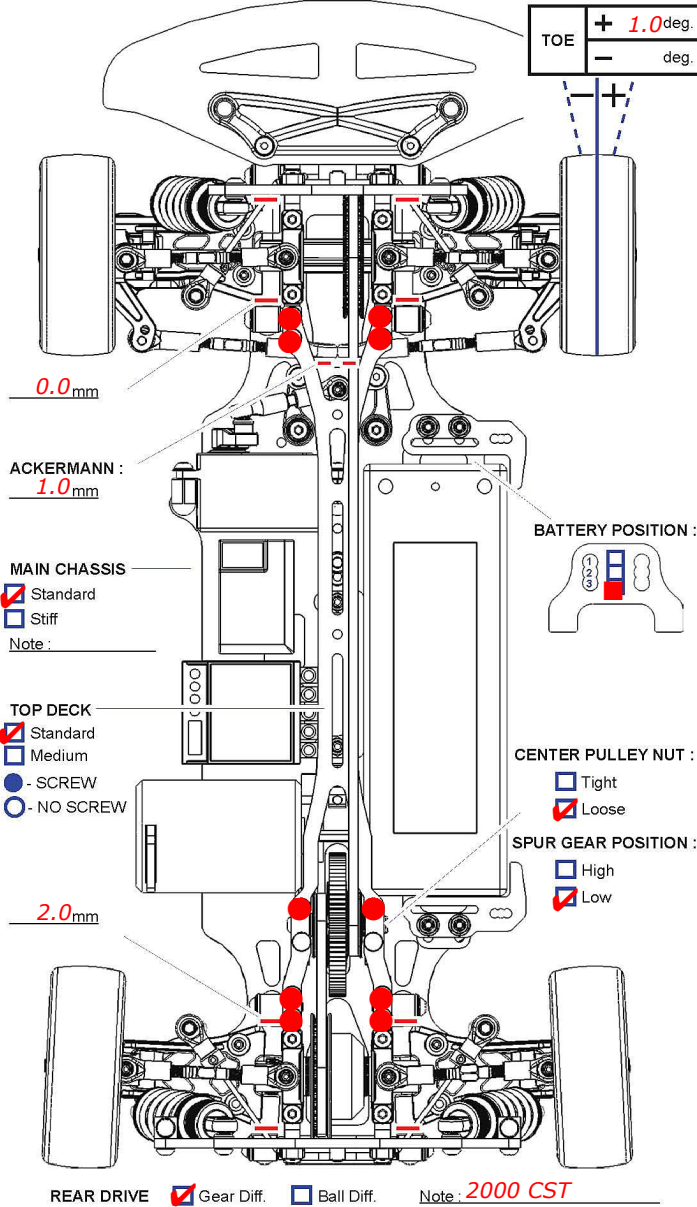

Name: Michael Hanulec Date: 7/14/2012 Air Temp: 90 °F
 Track: Jackson RC Country: USA Track Temp: °C
 Track Condition: Asphalt, Medium Grip
 Qualify: 2 Main: A Finish: 2 Fastest lap: 14.991

FRONT DRIVE Spool Gear Diff. Ball Diff. One-Way Note: Mira Outdrives



FRONT MEASUREMENTS

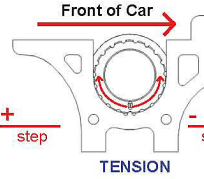

RIDE HEIGHT	<u>5.4mm</u>
CAMBER ANGLE	<u>2.0deg</u>
DOG BONE	<u>XRay ECS 50mm</u>
WHEEL HUBS	<u>5.2mm</u>
WHEEL SPACER	<u>NAmm</u>

FRONT SHOCKS

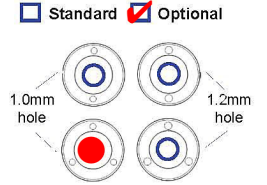

OIL WEIGHT	<u>Losi 45wt</u>
BLADDER	<u>Stock</u>
SPRING	<u>367</u>
NOTE	<u>Kyosho O-Rings</u>

REAR MEASUREMENTS

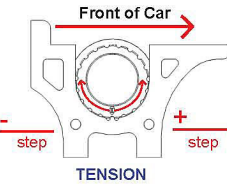

RIDE HEIGHT	<u>5.6mm</u>
CAMBER ANGLE	<u>2.25deg</u>
DOG BONE	<u>Top Alum 44.5mm</u>
WHEEL HUBS	<u>5.2mm</u>
WHEEL SPACER	<u>NAmm</u>

REAR SHOCKS

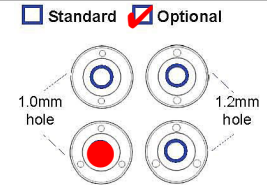

OIL WEIGHT	<u>Losi 42.5wt</u>
BLADDER	<u>Stock</u>
SPRING	<u>324</u>
NOTE	<u>Kyosho O-Rings</u>

MOTOR	<u>Hacker Skalar10 13.5</u>	FRONT	REAR
SPUR GEAR	<u>66</u>	BRAND	<u>Solaris</u>
PINION GEAR	<u>-BIG-</u>	COMPOUND	<u>Hard</u>
BATTERY	<u>OHP 60c 6000mah</u>	INSERT	<u>Premount</u>
BODY SHELLS	<u>LTC-R LtWt</u>	WHEEL	
WING		TIRE TREATMENT	<u>Buggy+Tweak</u>
ESC SETTING			
			<u>Blinky, 2x Tekin Caps</u>

FRONT

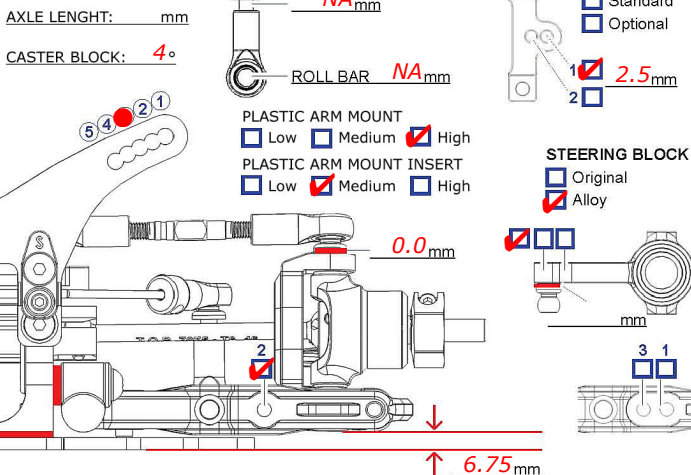

REAR

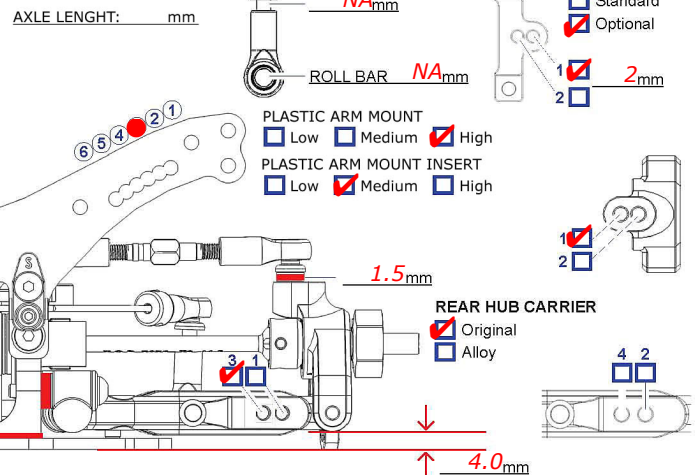

Side Piece Racing Mira Outdrives, Seis Fans, XRay 50mm ECS, XRay 4deg C-Hub, 2mm shim under dual bell crank

