

OWNER'S MANUAL

TEKIN RSX



- ◆ Sensored/Sensorless Compatible
- ◆ D2 Brushless Drive Technology
- ◆ Brushed/Brushless Compatible
- ◆ QuickTune™ Digital Setup
- ◆ HotWire & Datalogging Capability
- ◆ High Voltage Programmable BEC

FAN SHROUD & CAPACITORS

CAUTION: A power capacitor is supplied with the RSX and **MUST BE MOUNTED** on the ESC for proper operation (Figs. 2 & 3). Failure to use the power capacitor can cause irreparable damage to the ESC.

MOUNTING FAN SHROUD: Secure the included 7x23mm fan to the shroud using (4) 6/32 x 3/8 button head screws (sticker side down). Route fan wire as shown. The shroud is mounted to the RSX using (4) .08 x 1/2 screws and 3mm aluminum spacers. We also offer our "Worlds Kit" (TT3833) which includes a 10x23mm fan, new spacers and hardware for extra cooling in extreme conditions. (Fig. 1)

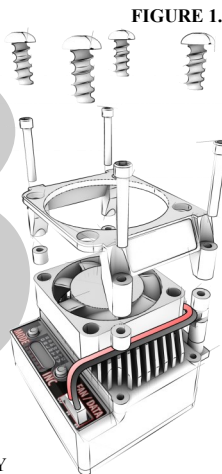

FIGURE 2.



POLARITY INDICATOR NEG (-).

SOLDERING CONT...

ATTACHING WIRES TO THE ESC:

1) RED is used for battery positive (+BATT) and "A" Phase of the motor. BLACK is for battery negative (-BATT) and "C" Phase. White is for "B" Phase.

2) Tin all the solder posts on the ESC. Apply solder to the iron tip, press it to the top of the post and feed more solder to fill the cradle in the post. This process should take no longer than 2-3 seconds repeat for remaining posts.

3) To tin the wires, strip the insulation back 3/32"- 1/8" and touch the iron tip to the exposed strands. Feed solder to the wire until it is evenly coated. 2-3 seconds again.

4) Attach the tinned wire to the tinned ESC post by heating both, bringing them together and heating again (Section 5). The solder should flow in 2-3 seconds. If you have trouble, clean and tin the solder tip and retry once the pieces have cooled.

ATTACHING WIRES TO THE MOTOR:

1) Be sure to connect your motor to your ESC with the proper wiring order: A - A, B - B, C - C.

2) Using the same techniques described above, solder the wires to your motor.

RADIO CALIBRATION

NOTE: Before Radio Calibrating, ensure the ESC is hooked up to the receiver in Channel 2 (CH2), a charged battery is properly connected, and the transmitter is turned on and bound to your receiver.

Refer to Section 10 below.

1) On your transmitter, set all trim adjustments to the middle, throttle/brake EPAs and Dual Rate set to 100.

2) Press and hold MODE for 3-5 seconds or until the ESC gives a 4 chime confirmation. It is now in calibration mode and will start by looking for the neutral signal first, while blinking the center (#4) LED with a simultaneous "beep" with each blink.

3) Once neutral is found, the 4 chime confirmation will sound again and the right (#7) LED will begin to blink, indicating the ESC is looking for a full throttle signal. Pull and hold full throttle until you hear the confirmation chime.

4) The ESC will then switch to the left (#1) LED and look for a full brake/reverse signal. Push and hold full brake until you hear the confirmation chime. After the confirmation, let go of the trigger and the ESC will arm, go to neutral and actively show the onboard temperature (Section 17 on reverse side).

QuickTune™

Tekin's QuickTune™

PRESS MODE TO ACCESS:
LED1 - DRAG BRAKE
LED2 - BRAKE STRENGTH
LED3 - CURRENT LIMITER
LED4 - NEUTRAL WIDTH
LED5 - TIMING PROFILES
LED6 - MOTOR TYPE
LED7 - VOLTAGE CUTOFF

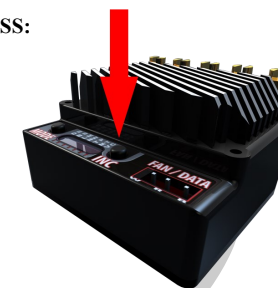

FIGURE 5.



PRESS INCR TO:
Adjust the feature currently selected. Refer to the QuickTune adjustments table below (section 13) for ranges of adjustment and what they accomplish.

INTRODUCTION

Congratulations and thank you for purchasing the RSX Brushless/Brushed Sensored Electronic Speed Control (ESC). The RSX comes from years of brushless R&D and supplies racers with the ultimate package for modified racing. The small footprint and optional fan shroud make the RSX versatile and able to cover a wide range of vehicles and applications.

BEFORE YOU BEGIN

Read through this manual and familiarize yourself with the terms, error codes and general workings of the ESC. Keep this manual for future reference.

- 1) The RSX is intended only for 1/10th scale and smaller vehicles that weigh under 4lbs ready to run.
- 2) Make sure the motor/battery are within recommended specs.
- 3) Check battery polarity; **NO** Reverse Polarity Protection.
- 4) Check polarity and labeling of solder posts before soldering.
- 5) Locate the power capacitor and note that it **MUST** be installed or warranty will be void.
- 6) Use in or around water can damage the ESC and void the warranty.

INSTALLATION

Plan Speed Control Placement

1) Choose a location for the ESC that is protected from debris and moving parts. Plan ahead with wire routing and try to keep the motor leads about the same length. Motor leads should be short, but not tight. Leave some slack in the wiring to account for chassis flex and vibrations while driving.

2) Mock up your wire lengths for your planned ESC placement. It is recommended to solder the power cap and all leads to the ESC before mounting to the chassis.

3) Choose a wiring method for the motor and battery leads. Direct wiring uses no plugs and provides the best connection between the motor and the ESC. You can use Tekin 4.0mm Hi-Power bullet connectors (TT3054, Fig 4.) for easy motor removal. Battery connector choice is up to you, use the female plug on the battery and the male on the ESC and double check the polarity.

4) To mount the ESC, clean the bottom with rubbing alcohol. NEVER use any chemicals such as motor spray or acetone as they will damage the plastic. Use the provided double sided tape or a 3M adhesive tape.

5) Secure the ON/OFF switch in a safe, accessible place away from moving parts and debris.

WIRING INSTRUCTIONS

1) CONNECT ESC TO RECEIVER

Plug the ESC into the throttle (TH) channel of the receiver.

- ◆ Channel 1: Servo
- ◆ Channel 2: ESC

"REMEMBER: 1 to Turn, 2 to Burn"

2) CONNECT ESC TO BATTERY

Visually verify that the connector on the battery pack and the ESC match the chart below then connect.

DO NOT CONNECT BATTERY INCORRECTLY TO ESC, VERIFY THAT THE BATTERY POSITIVE WIRE WILL CONNECT TO THE ESC POSITIVE WIRE BEFORE CONNECTING!

ESC	BATTERY
(B-) Black Wire	(-) Negative
(B+) Red Wire	(+) Positive

3) CONNECT ESC TO MOTOR

First, determine the type of motor you are using. **SENSORED** motors require the sensor harness, **SENSORLESS** motors do not. Wire as shown in Fig. 6 and the chart below.

Brushless Wiring

SPEED CONTROL	BRUSHLESS MOTOR
(A) Red Wire	(A) Red
(B) White Wire	(B) White
(C) Black Wire	(C) Black

Brushed Wiring

SPEED CONTROL	BRUSHED MOTOR
(-) Black Wire	(-) Negative
(+) Red Wire	(+) Positive

4.0 mm High power Connector Part # TT3054 (3 Pairs)

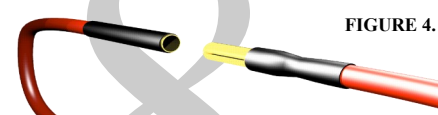

FIGURE 4.

FACTORY RESET

All Tekin ESCs have a built-in factory reset mode that resets all user programmable settings to the default values. To activate, turn the ESC on, then press/hold both the INCR and MODE buttons simultaneously for 3-5 seconds. The LEDs will ramp up in sets of three, confirming Factory Reset. **NOTE:** Performing a Factory Reset also resets all the radio calibration settings to their default values. A radio calibration will need to be done.

RADIO CALIBRATION, CONT...

STEP 1:



Power the transmitter and your ESC on.

STEP 2:

Press and hold MODE for 3 seconds.



LED BLINKING CENTER

LED BLINKING RIGHT

LED BLINKING LEFT

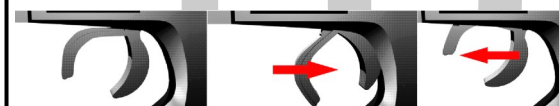

STEP 3: Leave trigger centered in Neutral. WAIT FOR CHIME

STEP 4: Pull and hold full throttle. WAIT FOR CHIME

STEP 5: Push and hold full brake. WAIT FOR CHIME

Hint: If the ESC fails to recognize your full throttle signal, try reversing the throttle channel in the transmitter system menu.

QUICKSTART

After properly installing your ESC, follow these steps for a quick setup:

- 1) With the ESC installed and properly wired, (Figs. 6, 7 & 8) connect the battery.
- 2) Turn the transmitter on FIRST, then the ESC.
- 3) Take note any codes that may be present. Refer to Section 18 on reverse side for codes.
- 4) Set transmitter throttle trims to 0 and throttle EPAs to 100. You can access these features in the system menu on the transmitter.
- 5) Perform a Radio Calibration, refer to Sections 9 & 10.
- 6) Factory default voltage cutoff is set for a 2S LiPo battery @ 6.4V. Double check the battery you are using and adjust Voltage Cutoff if needed.
- 7) Updating Firmware via HotWire:

You can connect to the RSX through the Fan/Data port as shown or through the receiver wire. Use the included adapter to connect through the port. Verify plug polarity, always black to the outside (black-out).

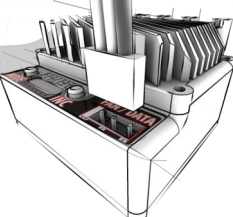

SOLDERING

Brushless wiring instructions refer to Fig. 6
Brushed, refer to Figs. 7 & 8 on reverse side.

Tips & Tricks

Placing the ESC in a vise (gently) provides a stable work area to do a quality job (Figure 3). Solder without the fan shroud/fan in place to avoid damaging them. The order for proper soldering is:

- ◆ Tin Posts
- ◆ Tin Wires
- ◆ Heat Posts
- ◆ Heat Wires
- ◆ Heat both and connect

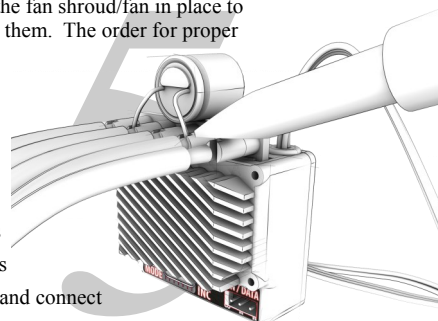

FIGURE 3.

Hint: If the wire is too hot to hold 2" away from the solder joint, the iron has been on for too long— stop, let everything cool and try again. Excessive heat can damage the ESC.

SPECIFICATIONS

Controls - RSX	Fwd/Brk or Fwd/Brk/Rev
Input (#Cells) RSX	4-9 NiCd/NiMH (2-3S LiPo)
Motor Limits - RSX	
Brushless (2S)	2.5Turn 2-Pole 36mm Can
Brushless (3S)	8.5Turn 2-Pole 36mm Can
Brushed (2S)	6Turn 36mm Can
Brushed (3S)	12Turn 36mm Can
Max Current RSX	180 Amps per Phase
Programmable BEC	6-7.4V / 5.5Amp
Dimensions With Fan Shroud	1.21 x 1.43 x .82" / 30 x 36 x 20mm 1.21 x 1.43 x 1.26" / 30 x 36 x 32mm
Weight	1.5oz / 42g

WARNING: Exceeding product specifications or using equipment outside of the specification ranges above automatically voids the 120-day manufacturer warranty. Any damage caused from misuse or use of equipment outside of the specifications will be subject to servicing and or replacement fees to be determined by the Tekin Service Department. For further warranty information, please refer to Section 26 or visit us on the web at www.teamtekin.com.

QuickTune™ MODES

MODE	RANGE	DEFAULT
DRAG BRAKE (DB)	1-13	1 (No Drag)
BRAKE/REVERSE STRENGTH (BS)—Brushless Mode Only	1-13	4&5
PUSH CONTROL ANTI DRAG (PC)—Brushed Mode Only	1-13	1 (Off)
CURRENT LIMITER (LM)	1-13	13 (No Limiter)
NEUTRAL WIDTH (NW)	1-13	2&3
TIMING PROFILE (TP)	1-7	1 (Spec Mode)
MOTOR TYPE (MT)	1-6	3 (Brushless)
VOLTAGE CUTOFF (VC)	1-4	2 (6.4V)

LED1: DRAG BRAKE provides immediate braking action in neutral. This gently slows the car down when you let off the trigger. Higher values increase the degree of drag braking.

LED2 (BRUSHLESS MODE): REV/BRAKE STRENGTH adjusts your maximum brake strength and reverse speed when in brushless mode. Higher values increase brake strength and increase reverse speed.

LED2 (BRUSHED MODE): PUSH CONTROL or ANTI-DRAG overcomes the natural drag of a brushed motor when throttle returns to neutral. Low values give you a short duration push, higher values a longer duration push.

LED3: CURRENT LIMITER adjusts the initial power delivered to the motor under acceleration. Low values will decrease the initial power and give a softer feel to the throttle. The highest value (13) gives full power to the motor, no limiter is in effect. Ex: Current Limiter at 80 gives 80% power.

LED4: NEUTRAL WIDTH adjusts the dead band around neutral. A low neutral width value will provide more precise and quick trigger sensitivity around neutral. Higher values decrease trigger sensitivity.

LED5: TIMING PROFILES are pre-programmed with 5 preset profiles and 2 Custom profiles. Setting 1-5 will put the speed control in Sensored Only mode and apply the preset amount of timing.
TP1: Spec Stock "blinky mode" 0*timing boost
TP2: 15* Timing Boost / RPM Range 5443-20,016
TP3: 25* Timing Boost / RPM Range 5443-20,016
TP4: 35* Timing Boost / RPM Range 5443-20,016
TP5: 45* Timing Boost / RPM Range 5443-20,016
RPM Ranges are divided in half when running in 1S LiPo Mode

QuickTune™ MODES CONT...



LED6: MOTOR TYPE

- 1) Brushless, Fwd/Brk (LED1 ON)
- 2) Brushless, Fwd/Immediate Rev (LED1-LED2 ON)
- 3) Brushless, Fwd/Brk/Rev Delay (LED1-LED3 ON)
- 4) Brushed, Fwd/Brk (LED1-LED4 ON)
- 5) Brushed, Fwd/Brk/Rev (LED1-LED5 ON)
- 6) Brushed, Fwd/Brk/Rev Delay (LED1-LED6 ON)

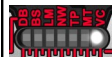

LED7: VOLTAGE CUTOFF

IMPORTANT: If using LiPo batteries, ensure a proper Voltage Cutoff is programmed.

- 1) 3.2 Volts (LED1 ON). 1 Cell LiPo (1S) and NiCd/NiMh
- 2) 6.4 Volts (LED1-LED2 ON). Use for 2 Cells LiPo (2S)
- 3) 9.6 Volts (LED1-LED3 ON). Use for 3 Cells LiPo (3S)
- 4) Custom (LED1-LED4 ON). HotWire required

LED Display: The LED light bar displays values and settings on your speed control in a few ways. Settings with a range of 1-7 are shown by just one LED at a time. Settings with a wider range of 1-13 are shown by a combination of 1 and 2 LEDs at the same time. While adjusting, the LEDs will "walk" up the ladder in a way that 1 will be lit, followed by 1&2, then 2&3 and so on. Critical settings (such as Motor Type and Voltage Cutoff) are always indicated by multiple LEDs at a time to ensure proper adjustment.

THROTTLE PROFILES

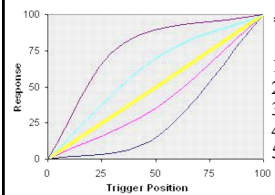

Accessible via HotWire

- 1) Mildest profile - concave
- 2) Mild profile - concave
- 3) Linear profile (DEFAULT)
- 4) Aggressive profile - convex
- 5) Most Aggressive profile - convex

OPERATING TIPS

DRAG BRAKE: Increased drag brake settings help by allowing you to concentrate less on braking, more on driving a good line and can also be very helpful with free-spinning slotless motors.

BRAKE STRENGTH: Reducing your brake strength helps control skidding during heavy braking and on loose surfaces.

NEUTRAL WIDTH: A tight neutral width can interfere with correct operation of Drag Brake and Push Control if your radio trigger does not return precisely to the same neutral position.

TIMING PROFILES: These are a huge performance increase and can damage equipment when not used properly. Too much Boost can cause problems and Boosting modified motors needs to be done with care and a proper setup.

TEMPERATURE MONITOR

The On-Board Temperature Monitor works to provide you with important feedback on ESC temperature, helping you to adjust gearing and avoid long term heat damage. To use;

- 1) The ESC must be calibrated to your transmitter and must be in neutral.
- 2) The middle LED will be on steady then blink out every 2 seconds. *Blinky mode will show LEDs 3 & 5 blinking rapidly in neutral and Locked Spec Mode will show LEDs 3, 4 & 5 blinking rapidly.*
- 3) At the moment that the center LED blinks out, one or more of the other LEDs will light up.
- 4) LED Temperature readings:

LED1	LED1-2	LED1-3	LED1-4	LED1-5	LED1-6	LED1-7
Ambient	120°F	140°F	160°F	180°F	200°F	220°F

Should your ESC show all 7 LEDs, stop driving and let it cool. The ESC will go into Thermal Shutdown if it is not allowed to cool down. You may need to lower your gearing, lower your Boost settings, change to a higher turn motor or repair any binding in the drivetrain. Continuous use at high temperatures and multiple "thermals" can damage the ESC.

IMPORTANT LED CODES

Your ESC is an intelligent piece of equipment and can usually tell you exactly what the problem is. Refer to this section should your ESC show you any LED sequence out of the ordinary. You can also go to www.teamtekin.com/rs_troubleshoot.html to see these codes in action. Each code will FLASH rapidly:

ALL LEDS FLASHING	No signal from receiver. Check that receiver bind light is on and ESC is plugged into CH2.
LEDS 1, 2, 6 & 7	Wrong motor type, or internal short in ESC or motor detected. Check motor wire solder joints.
LEDS 1, 2 & 3	LOW neutral signal. Adjust radio trims to center and perform radio calibration.
LEDS 5, 6 & 7	HIGH neutral signal. Adjust radio trims to center and perform radio calibration.
LEDS 1, 3 & 5	LOW VOLTAGE CUTOFF. Battery voltage is below programmed voltage cutoff. Charge battery.
LEDS 3 & 5	Spec Mode activated. Sensored-Only, no Timing or Boost. ROAR Legal.
LEDS 3, 4 & 5	Big Event Spec Lockout mode activated. Can only be undone via HotWire™. ROAR Legal.

TROUBLESHOOTING

HINT: When powered on, the ESC emits an all-systems-go chime if it is connected correctly to the motor and radio. Check the above chart for any codes that may be present.

NO LIGHTS COME ON

- ◆ Check battery charge and polarity.
- ◆ Verify that the switch is in the ON position.
- ◆ Check all solder joints and plugs for a good connection.
- ◆ Unplug your servo from your receiver. A shorted servo can cause power up issues.
- ◆ Unplug sensor harness, possible sensor board short.
- ◆ Check ESC receiver plug for proper polarity.
- ◆ Re-flash ESC with HotWire. Incomplete or interrupted updates can "brick" the ESC.

ALL LEDS FLASHING

- ◆ Check that transmitter and receiver are properly bound.
- ◆ Check ESC receiver plug for correct polarity and that it is plugged into CH2.

WILL NOT CALIBRATE

- ◆ Check transmitter batteries and replace if necessary.
- ◆ Reverse throttle channel on transmitter if necessary.
- ◆ Check that transmitter and receiver are properly bound.

NO STEERING OR THROTTLE

- ◆ Check battery voltage and polarity.
- ◆ Check that transmitter and receiver are properly bound.
- ◆ Check receiver plugs for correct polarity or damaged wires.

STEERING WORKS, NO THROTTLE

- ◆ Check for Low Voltage Cutoff code.
- ◆ Check battery voltage.
- ◆ Check motor connections, try another motor if possible.
- ◆ Check ESC plug for correct polarity and damaged wires.

THROTTLE WORKS, NO STEERING

- ◆ Shorted or broken servo.
- ◆ Check servo plug for correct polarity and damaged wires.
- ◆ Replace servo.

MOTOR RUNS BACKWARDS

- ◆ Check transmitter throttle reverse setting.
- ◆ Verify motor wires are connected A - A, B - B and C - C. Wiring improperly while running a sensored motor with the sensor harness will damage the ESC.

MOTOR RUNS WITH NO THROTTLE INPUT

- ◆ Set transmitter throttle trim to 0. If anything other than 0 is needed, perform a radio calibration with the trim at 0.

TROUBLESHOOTING CONT...

LEDS 1, 2, 6 & 7 FLASHING

- ◆ Wrong Motor Type Selected.
- ◆ Internal ESC or Motor Short Detected.
- ◆ Try a different brushless motor.

NO REVERSE

- ◆ Motor Type set to MT1 (no reverse.)
- ◆ Motor Type set to MT3 (reverse delay.) Needs 1 full second in neutral before reverse will activate.

NO BRAKES

- ◆ Check transmitter Low Throttle EPA adjustments.
- ◆ Check Brake Strength settings in the ESC.
- ◆ Check for proper radio calibration. All LEDs should flash at full throttle and full brakes/reverse.

DATALOGGING MEMORY GAUGE

You can check the memory usage of the Datalogging feature by pressing and releasing the INCR button once. 1LED means no data has been recorded and all 7LEDs means memory is full. To reset and erase the datalog memory, press and hold the INCR button. The ESC will chime and flash before going back to neutral. The HotWire is needed to open and view datalogs (Section 23).

D2™ & SENSORED OPERATION

The RSX speed control is capable of running all brushless motors in sensorless mode, whether or not they have a sensor harness. The RSX will auto-detect any sensors and if present will operate in Dual Drive mode as standard. If no sensors are detected, the RSX will run sensorless. Tekin's D2 Dual Drive technology allows the ESC to start in sensored mode and switch to sensorless mode at higher RPMs for efficiency. This is a great feature for modified racing. Dual Drive and sensorless use the Timing Advance function, while running in Sensored-Only utilize the Boost and Turbo functions. The RSX is a very versatile piece of equipment as it has the capability to run brushless motors with sensors and without, as well as brushed motors.

CHECKING SENSOR OPERATION

With Tekin ESCs you can quickly verify your ESC and sensored motor are communicating properly with the on-board sensor checker feature. Simply observe the right three LEDs (5, 6 & 7) with the ESC powered on and rotate the motor shaft slowly. If the sensor cable is plugged in and the sensors are operating correctly, you should see the three LEDs rotate through as each sensor is activated. This indicates that all sensors are functioning properly and the system is good to go. Should a sensor go bad or the cable become disconnected while driving, the RSX will automatically default to sensorless drive mode, allowing you to finish the race.

HotWire™ PROGRAMMING DEVICE

The HotWire PC Interface (TT1450) unlocks the full potential of your Tekin ESC. Offering a wide range of adjustable features and options, you can fully customize your setup to any particular track and any driving conditions. The HotWire can also be used to download Tekin Driver setups from the website and load them directly into your ESC. You want a pro racer's championship winning setup? No problem! The HotWire makes it easy to load custom setups and save your own for any track and any car for use later. Setup notes can be applied and saved with each user-created ESC profile so you can have the exact same setup you had before, which takes all the guess work out of the equation!

Tekin frequently releases new firmware for ESCs, which can be downloaded from the website and flashed to the ESC. This means a longer lifespan for your ESC! With access to tons of features not fully accessible from the onboard interface, the HotWire is a must have item. User-defined Custom Throttle Profiles, Custom Voltage Cutoffs, Custom Boost and Turbo settings, adjustable RPM Ranges for Boost and Turbo and even a new Datalogging feature can all be tuned via the HotWire on Windows XP or higher desktops, laptops, netbooks and tablets. It's all here at your fingertips, a fully customizable professional racing system.

Check out more at www.teamtekin.com/hotwire.html

BRUSHLESS MOTOR WIRING DIAGRAM

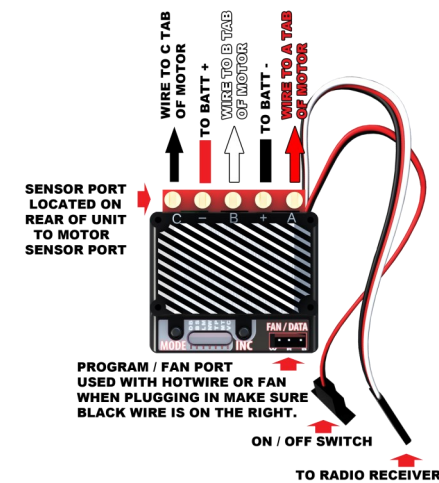

MOTOR TYPE (MT) SETTINGS
 MT1 / LED 1 - FWD/BRK
 MT2 / LED 2 - FWD/REV IMMEDIATE
 MT3 / LED 3 - FWD/BRK/REV DELAY

BRUSHED MOTOR WIRING DIAGRAM

FORWARD / REVERSE

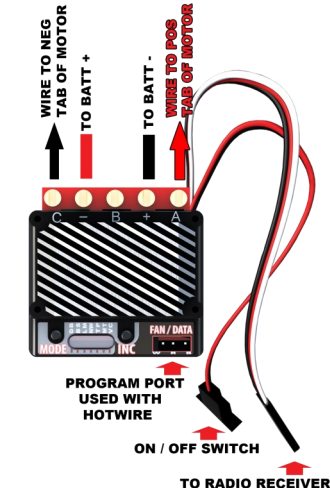

MOTOR TYPE (MT) SETTINGS
 MT5 / LED 5 - FWD/REV IMMEDIATE
 MT6 / LED 6 - FWD/BRK/REV DELAY

FORWARD ONLY

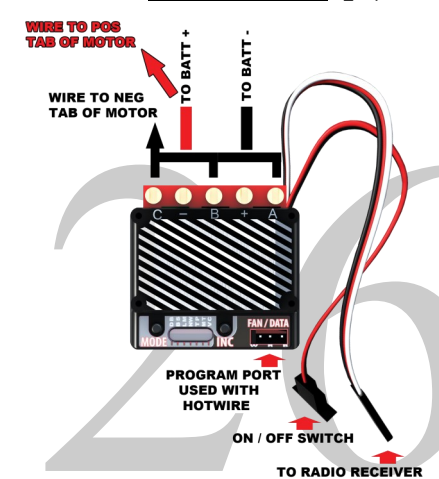

MOTOR TYPE (MT) SETTINGS
 MT4 / LED 4 - FWD/BRK

BRUSHLESS MOTORS

For Brushless Connection, Refer to Figure 6.

1) Wiring: Connect A, B and C wires from the motor to the A, B and C posts on the ESC, verify this is correct for proper function. Determine whether you would prefer to use connectors from ESC to motor. Refer to the instructions in the Soldering section of this manual for more information and refer to Figures 3 & 6.

2) Connect the battery pack: BATT (+) to ESC BATT (+) then BATT (-) to the ESC BATT (-).

3) Select Motor Type: Press and release the MODE button 6 times to get to the MOTOR TYPE selection in the user settings. Press and release the INC button once to view the current motor type selected (brushless types are indicated by LEDs 1-3 lit). If necessary, continue to press and release the INC button to scroll through the motor types until brushless motor type is selected.

4) Power off the ESC and connect the motor wires if using plugs, matching colors appropriately if applicable.

Remember (A - A, B - B and C - C ALWAYS.)

5) Power on the ESC, listen for the arming chime.

BRUSHED MOTORS

For Brushed Wiring Configurations Refer To Figs 7 or 8.

1) Wiring: Forward/Reverse Wiring (Motor Types 5&6): Refer to Fig. 7, connect motor NEG (-) terminal to speed control (C) post, then connect motor POS (+) terminal to ESC (A) post. NOTE: Speed control (B) post is not used.

2) Forward Only Wiring (use only Motor Type 4): Refer to Fig. 8. Connect all 3 ESC motor outputs (ABC) together, then connect them to the NEG (-) terminal of the motor. Connect another wire from the motor POS (+) terminal to the BATT (+) terminal on the ESC.

3) Connect the battery pack: BATT (+) to the speed control BATT (+) then BATT (-) to the speed control BATT (-).

4) Select Motor Type: Press and release the MODE button 6 times to get to the MOTOR TYPE selection in the user settings. Press and release the INC button once to view the current motor type selected (brushed types are indicated by LEDs 1-4, 1-5, or 1-6 lit—See QuickTune Modes section for motor type details).

5) Power off the ESC and connect the motor wires if using plugs, matching colors and polarity appropriately if applicable.

6) Power on the ESC, listen for the arming chime.

WARRANTY / REPAIR

TEKIN, INC. guarantees ESCs to be free from factory defects in materials and workmanship for a period of 120 days from date of purchase, when verified by sales receipt. This warranty does not cover: suitability for specific application, components worn by use or improper voltage, tampering, misuse, or shipping. Our warranty liability shall be limited to repairing unit to our original specifications. Because we have no control over the installation or use of this product, in no case shall we be liable for damages. Additionally, these items void the warranty:

- 1) Using the same polarity connectors on the battery and motor wires from the ESC.
- 2) Allowing water or moisture into the ESC.
- 3) Failure to attach the supplied capacitor.
- 4) Incorrect wiring or use inconsistent with the instructions.

WARRANTY SERVICE: For warranty work, you MUST CLAIM WARRANTY on A COMPLETELY FILLED OUT PRODUCT SERVICE FORM and include a VALID CASH REGISTER RECEIPT with purchase date, dealer name & phone# on it, or an invoice from previous service. If warranty provisions have been voided, there will be service charges.

REPAIR: Before sending your speed control in for service, please review the Instructions and Troubleshooting sections. After reviewing these instructions, if your speed control still requires service, please contact our customer service department for additional assistance.

NOTE: Hobby dealers or distributors are not authorized to replace TEKIN products thought to be defective.

Tekin, Inc.
 McCall, Idaho
 (208) 634-5559
www.teamtekin.com