

DRIVER, TRACK AND RESULTS

DRIVER	COUNTRY	WEATHER	AIR TEMP	TRACK TEMP	<input type="checkbox"/> DRY	<input type="checkbox"/> INTERMEDIATE	<input type="checkbox"/> WET
TRACK	SURFACE <input type="checkbox"/> ASPHALT <input type="checkbox"/> CARPET	TRACTION <input type="checkbox"/> LOW <input type="checkbox"/> MEDIUM <input type="checkbox"/> HIGH	COMMENTS				
RACE	DATE	QUALIFY	MAINS	FINAL			

FLEX CONFIGURATION

CHASSIS ALU CARBON

CENTER SHOCK ABSORBER

OIL REBOUND mm

PISTON

SPRING 6.5 8 10 12 14 16 18

OTHER:

CENTER TUBES

OIL ROLL LIMITER mm

FRONT **TYRES** Controlled Tyre REAR

TYRE

DIAMETER (mm)

ADDITIVE

ADDITIVE TIME (min)

SURFACE (%)

NOTES

ELECTRONICS

BATTERY

MOTOR

ESC

RATIO CONFIGURATION

PINION **SPUR** **PITCH**

FDR ROLLOUT mm

AERODYNAMIC CONFIGURATION

BODY

ARNO - PETITRE.COM

FRONT

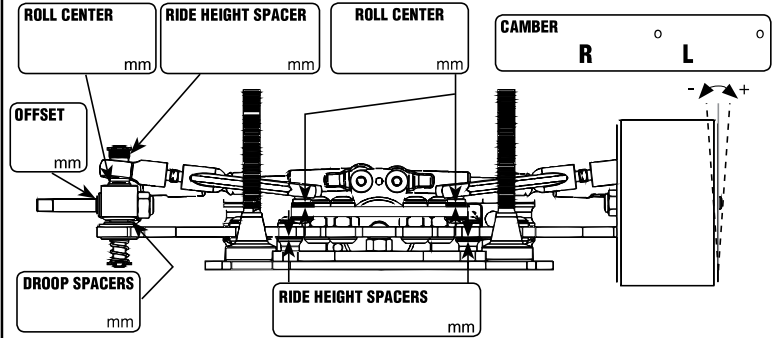

FRONT

REAR

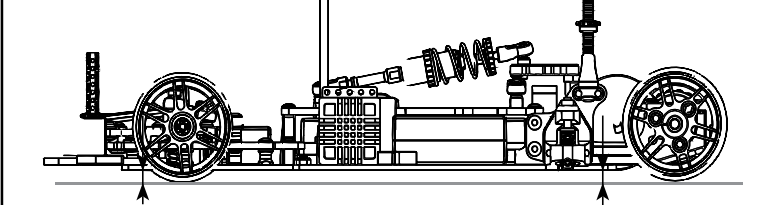

RIDE HEIGHT (mm)

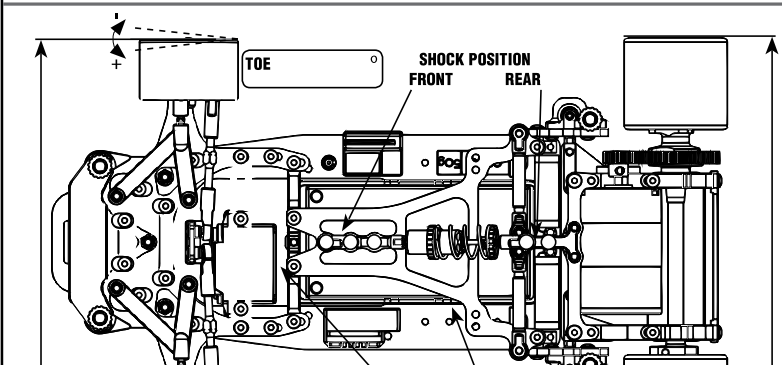
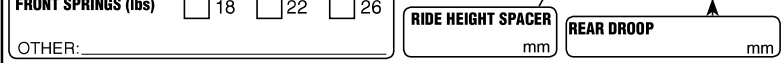
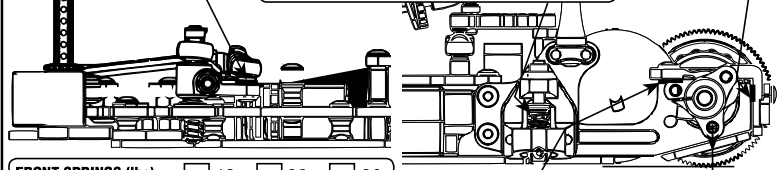
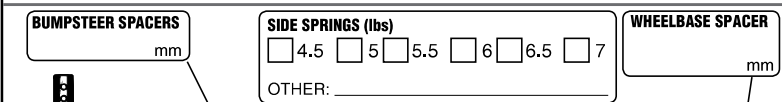
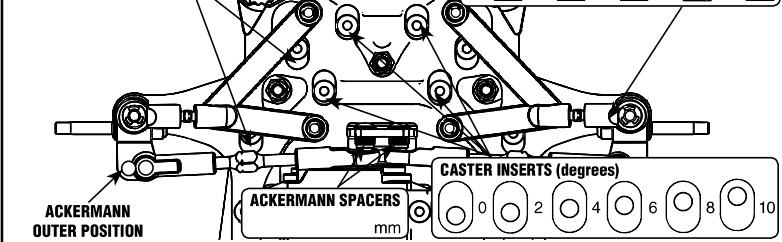
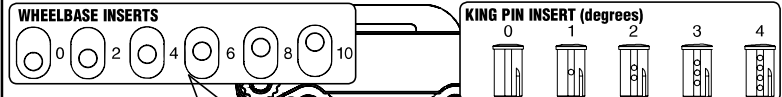

WEIGHT DISTRIBUTION

CAR WEIGHT grs

BATTERY POS. INLINE CROSS

ESC POS. RIGHT LEFT CENTER

BALAST FRONT LEFT RIGHT

g g g

REMARKS