

## DRIVER AND EVENT DETAILS

Name

Date

Event

Weather

Result

## CHASSIS AND ELECTRICS

Chassis

Top Deck

Bodyshell

Wing

E.S.C

Servo

Receiver

Cells

## TRACK CONDITIONS

Grip Level High  Medium  Low

Type Tight  Open  Both

Surface Carpet  Tarmac  Wood

Condition Smooth  Bumpy

Temperature  °C  °F

Venue Indoor  Outdoor



## MOTOR AND GEARING

Motor

Rotor Diameter

Timing

Gear Pitch 48Dp  64Dp

Spur Size

Pinion Size

Transmission  
Option 1  Option 2

## WHEELS, TYRES AND INSERTS

Wheels

Tyres

Inserts

Tyre Additive

Additive Time MIN (R)  MIN (F)

Tyre Warmers Yes  No

## DRIVER NOTES

## Front Shocks

Oil  WT

Springs

Piston Holes 2  3

length

Rebound  %

## FRONT SETTINGS

Drive Diff  Spool  One-Way  Height High  Low

Servo Saver Yes  No  Yoke Flex X  M  STD

Pivot Blocks Moulded (std)  Alloy

Screw Block Spacers Front  mm Rear  mm

Wishbone Quik-Klips Front  mm Rear  mm

Toe In-Out In-board  Out-board  °

Ride Height (Chassis to Floor)  mm

Droop On 10mm Block  Axle Height  mm

Anti-roll Bar No  1.20  1.40  1.60

Castor 0°  2°  4°  6°

Camber Positive  Negative  Deg

Link Washers Under Ball  Under Bracket  mm

Inboard Pin Kick-up  Anti-dive  Horizontal

Pivot Block Spacers Front  mm Rear  mm

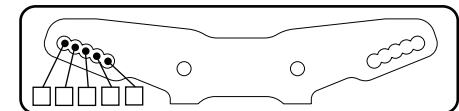
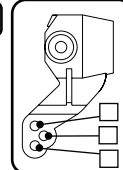
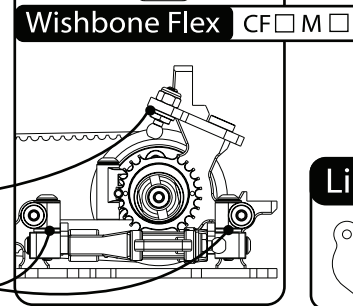
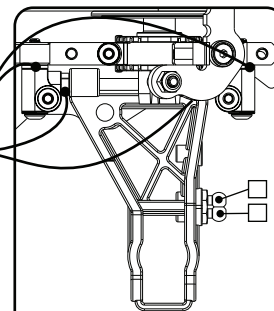

## Centre Track Rod

Washers  mm

## Link Mount

1 Groove - 45mm

2 Groove - 42mm

3 Groove - 39mm

4 Groove - 37mm

## REAR SETTINGS

Drive Height High  Low

Pivot Blocks Moulded (std)  Alloy

Screw Block Spacers Front  mm Rear  mm

Wishbone Quik-Klips Front  mm Rear  mm

Toe In In-board  ° Out-board  °

Ride Height (Chassis to Floor)  mm

Droop On 10mm Block  Axle Height  mm

Anti-roll Bar No  1.20  1.40  1.60

Camber Positive  Negative  Deg

Link Washers Under Ball  Under Bracket  mm

Inboard Pin Pro-Squat  Anti-Squat  Horizontal

Pivot Block Spacers Front  mm Rear  mm

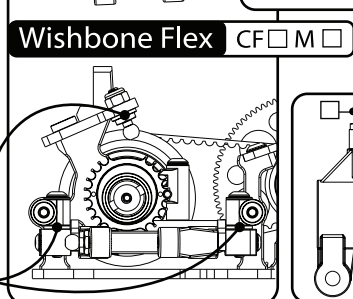
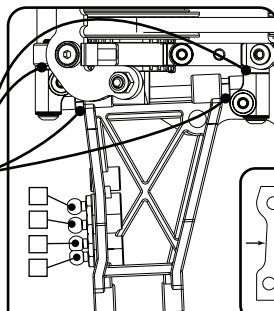

## Link Mount

1 Groove - 45mm

2 Groove - 42mm

3 Groove - 39mm

4 Groove - 37mm

1.4mm

2.4mm

3.4mm

4.4mm

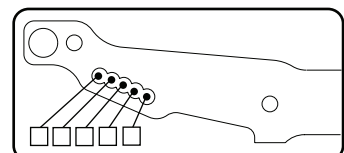

## Wishbone Flex

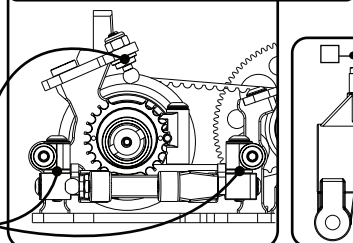

## Rear Shocks

Oil  WT

Springs

Piston Holes 2  3

length

Rebound  %