

**DRIVER AND EVENT DETAILS**

Name **Alexandre Laurent**  
 Date **23 Mar 2008**  
 Event **French Nationals Rd1**  
 Weather  
 Result **Qualify 3rd, Finish 1st**

**CHASSIS AND ELECTRICS**

Chassis **5 cells Euro Spec**  
 Top Deck **Flex**  **Standard**  **Stiff**   
 Bodyshell **Mazda B Light**  
 Wing **--**  
 E.S.C. **NOGRAM**  
 Servo **KO 2314**  
 Receiver **Ko Propo**  
 Number of Cells **4**  **5**  **6**   
 Type of Cells **1B4600**

**TRACK CONDITIONS**

Grip Level **High**  **Medium**  **Low**   
 Track Type **Tight**  **Open**  **Both**   
 Surface **Carpet**  **Tarmac**  **Wood**   
 Venue **Indoor**  **Outdoor**   
 Track Condition **Smooth**  **Bumpy**   
 Track Temperature **25 °C** °F

**DRIVER NOTES**

Short center track rod

**MOTOR AND GEARING**

Type **Brushed**  **Brushless**   
 Motor **3.5**  
 Brush **--**  
 Spring **--**  
 Timing  
 Gear Pitch **48Dp**  **64Dp**   
 Spur Size **118**  
 Pinion Size **20**

**WHEELS, TYRES AND INSERTS**

Wheels **GM**  
 Tyres **Sorex 36**  
 Inserts **GM Green**  
 Tyre Additive **Fish**  
 Additive Time **45 MIN (R) 45 MIN (F)**  
 Tyre Warmers **Yes**  **No**

**FRONT SETTINGS**

Drive **Diff**  **Spool**  **One-Way**  Height **High**  **Low**

Servo Saver **Yes**  **No**   
 Toe In-Out **In-board**  **Out-board**  **0° Toe-out**  
 Screw Block Spacers **Front 2 mm** **Rear 2 mm**  
 Wishbone Quik-Klips **Front 1.5 mm** **Rear 1.5 mm**  
 Link Washers (Horizontal) **3** mm  
 Ride Height (Chassis to Floor) **5** mm  
 Droop (Chassis to Floor) **Middle Axle 25** mm  
 Anti-roll Bar **Yes**  **No**  **1.20**  **1.40**  **1.60**   
 Castor **0°**  **2°**  **4°**  **6°**   
 Camber **Positive**  **Negative**  **1** Deg  
 Link Washers (Vertical) **1** mm  
 Inboard Pin **Kick-up**  **Anti-dive**  **Horizontal**   
 Pivot Block Spacers **Front 1 mm** **Rear 1 mm**

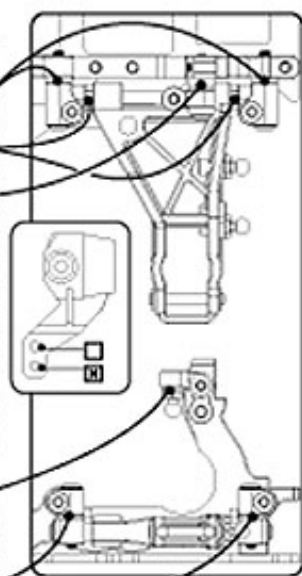
**Front Shocks**

Oil **30** WT  
 Springs **Blue**  
 Piston Holes **2**  **3**   
 length **62**  
 Rebound **50** %

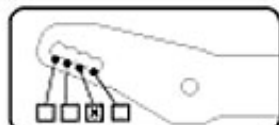
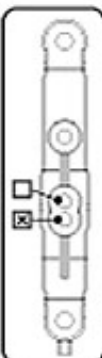
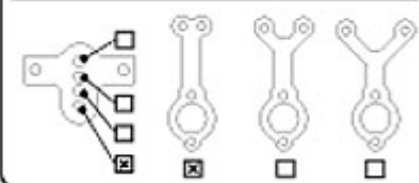
**Centre Track Rod****REAR SETTINGS**

Drive Height **High**  **Low**

Toe In **In-board**  **3°** **Out-board**  **0°**  
 Screw Block Spacers **Front 2 mm** **Rear 2 mm**  
 Wishbone Quik-Klips **Front 1.5 mm** **Rear 0.5 mm**  
 Link Washers (Horizontal) **2** mm  
 Ride Height (Chassis to Floor) **5.5** mm  
 Droop (Chassis to Floor) **Middle Axle 24.5** mm  
 Anti-roll Bar **Yes**  **No**  **1.20**  **1.40**  **1.60**   
 Camber **Positive**  **Negative**  **1.5** Deg  
 Link Washers (Vertical) **1** mm  
 Inboard Pin **Pro-Squat**  **Anti-Squat**  **Horizontal**   
 Pivot Block Spacers **Front 2 mm** **Rear 2 mm**

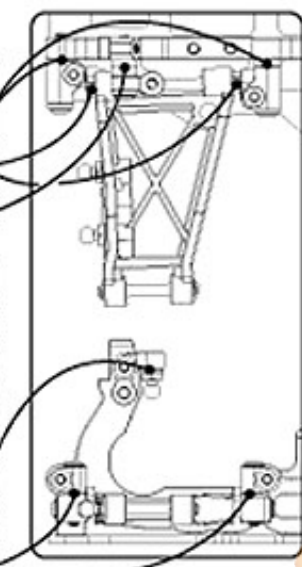
**Rear Shocks**

Oil **35** WT  
 Springs **White**  
 Piston Holes **2**  **3**   
 length **62.5**  
 Rebound **50** %

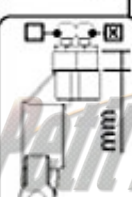
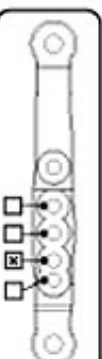
**Driver Notes**