

DRIVER DETAILS

NAME Martin Hofer

DATE -

EVENT standard setup

WEATHER -

RESULT -

CHASSIS AND ELECTRICS

CHASSIS standard Rear Motor Mid Motor

TOP DECK standard

BODYSHELL Pf Speed 6 LW, 5mm forward

WING Mr33, 17mm high, 10mm overhang

E.S.C GM Genius Pro

SERVO GM HGM SLP (SHR mode)

RECIEVER Sanwa 451R

CELLS GM V-Maxx

CELL POSITION Forward Middle Rearward

TRACK CONDITIONS

GRIP LEVEL High Medium Low

TYPE Tight Open Mixed

SURFACE Carpet Tarmac

CONDITION Smooth Bumpy

TEMPERATURE °C °F

VENUE Indoor Outdoor

NOTES

ride 32 tires: 5.5/4.5 droop, because those are bigger

outdoor / on tarmac:
schumacher green springs
allround and 3000cst diff-oil

Mi5

Schumacher
racing-cars.com

MOTOR AND GEARING

MOTOR GM Race 5.5T

ROTOR DIAMETER 12.5

TIMING std

GEAR PITCH 48DP 64DP

SPUR SIZE 114

PINION SIZE 25

WHEELS, TYRES AND INSERTS

WHEELS preglued

TYRES VTEC CPX / Ride 32 / REX34

INSERTS

TYRE ADDITIVE LRP 3

ADDITIVE TIME Front 15 Minutes Rear 15 Minutes

TYRE WARMERS Yes No Temp °C Time Minutes

REAR

Ball Diff
 Gear Diff



Diff Oil 5000 cTs



1.1mm - Yellow
 1.2mm - Red
 1.3mm - Green
 1.4mm - Blue
 1.5mm - Grey
 1.6mm - Orange

Droop..... 4.0 mm
On 10mm Block

Ride Height 5.2 mm
Camber..... 2.0 Degree's

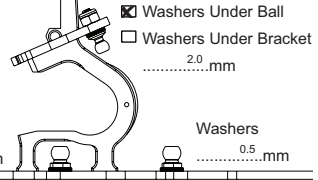

Washers Under Ball
 Washers Under Bracket 2.0 mm

Washers 0.5 mm

3 Groove 39mm
 4 Groove 37mm

(4 Groove shown)

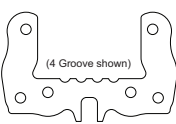

Washers 1.0 mm

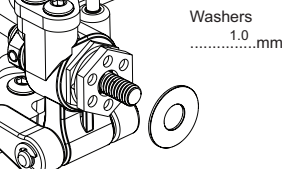

(2 Pip shown)

0 Groove
 1 Groove
 2 Groove

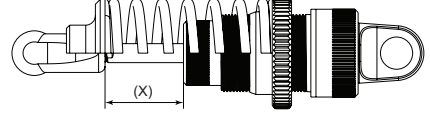
CAP TYPE Vented Sealed Emulsion

OIL..... 500 cTs

SPRING..... Yokomo blue

PISTON..... standard

DRILLED Yes No

DRILLED PISTON HOLE SIZE..... mm

SHOCK LENGTH (X)..... 10.5 mm

REBOUND minimum (10%)

0 Pip 3.0°
 1 Pip 2.5°
 2 Pip 2.0°

(2 Pip shown)

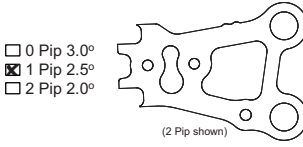
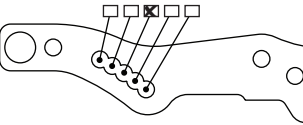
Washers 1.0 mm

WheelBase
 Short
 Middle
 Long

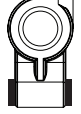

Alloy Steel



FRONT

Spool
 Gear Diff



Diff Oil cTs



1.1mm - Yellow
 1.2mm - Red
 1.3mm - Green
 1.4mm - Blue
 1.5mm - Grey
 1.6mm - Orange

Washers Under Ball
 Washers Under Bracket 1.5 mm

Droop..... 5.0 mm
On 10mm Block

Ride Height 5.0 mm
Camber..... 1.5 Degree's
Toe-in..... Degree's
Toe-out..... 1.0 Degree's

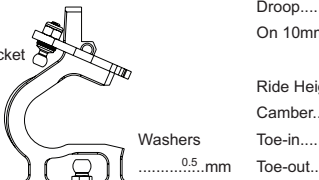

Washers 0.5 mm

3 Groove 39mm
 4 Groove 37mm

(4 Groove shown)

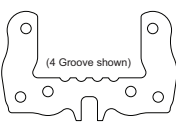

Washers mm

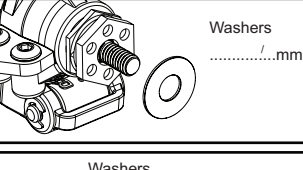

Washers 1.5 mm

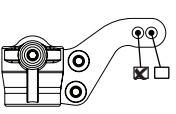
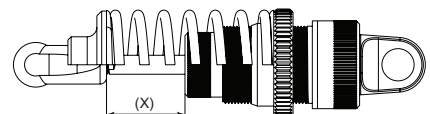
CAP TYPE Vented Sealed Emulsion

OIL..... 450 cTs

SPRING..... Yokomo pink

PISTON..... standard

DRILLED Yes No

DRILLED PISTON HOLE SIZE..... mm

SHOCK LENGTH (X)..... 10.5 mm

REBOUND minimum (10%)

4° Yoke
 6° Yoke

Yes No

SERVO SAVER

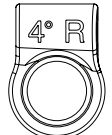

Washers 0 mm

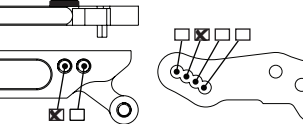

Washers 1.0 mm

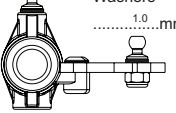

Alloy Steel Double Joint

