

TRACK CONDITION

ENVIRONMENT: INDOOR OUTDOOR
 COMPOSITION: CARPET ASPHALT
 TRACTION: LOW MEDIUM HIGH
 LAYOUT: SLOW MIXED FAST
 SURFACE: BUMPY SMOOTH
 NOTE: _____

ELECTRONICS

MOTOR: _____ TIMING: _____
 PINION: _____ SPUR: _____
 ESC: _____
 BATTERY: _____
 SERVO: _____
 RECEIVER: _____

SHOCK ABSORBERS

FRONT _____ REAR _____
 PISTON: _____ PISTON: _____
 OIL: _____ OIL: _____
 SPRING: _____ SPRING: _____
 REBOUND: _____ REBOUND: _____
 NOTE: _____

ANTI-ROLL BAR

FRONT: 1.2 1.3 1.4 1.5 _____
 REAR: 1.1 1.2 1.3 1.4 _____

TIRES & WHEELS

TIRE: _____
 INSERT: _____
 WHEEL: _____
 TREATMENT: _____
 NOTE: _____

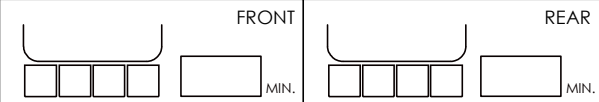

SERVO SAVER POSITION



TRANSMISSION HEIGHT

SPOOL _____ DIFFERENTIAL _____
 HIGH HIGH OIL: _____
 LOW LOW

FLEX

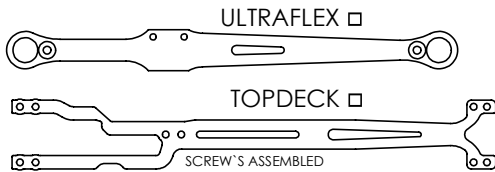

AERODYNAMICS

BODY: _____
 WING: _____

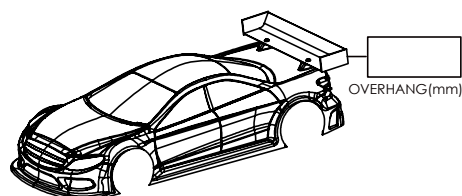

CASTER POSITION

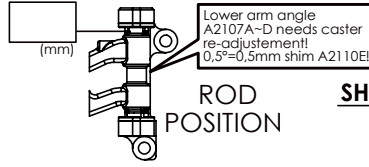

FF: A2105A/A2104
 1pc. 2pcs.

FR: A2105B/A2104
 1pc. 2pcs.

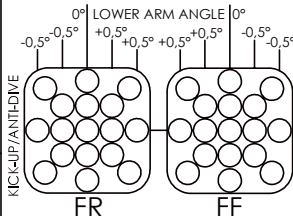

KICK-UP/ANTI-DIVE

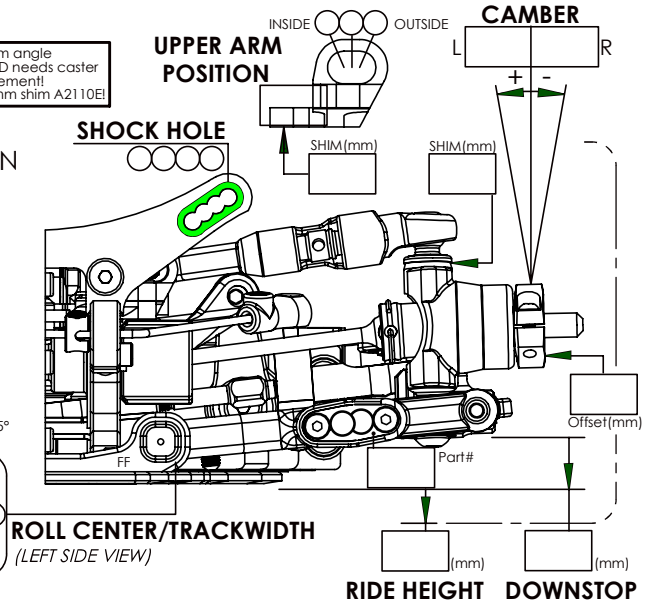

CAMBER LINK POSITION

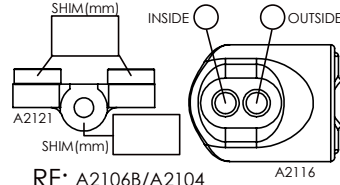

RF: A2106B/A2104
 1pc. 2pcs.

RR: A2106A/A2104
 1pc. 2pcs.

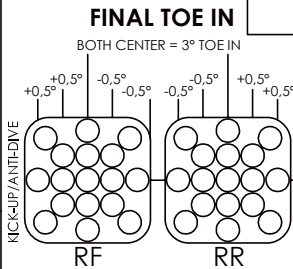

KICK-UP/ANTI-DIVE

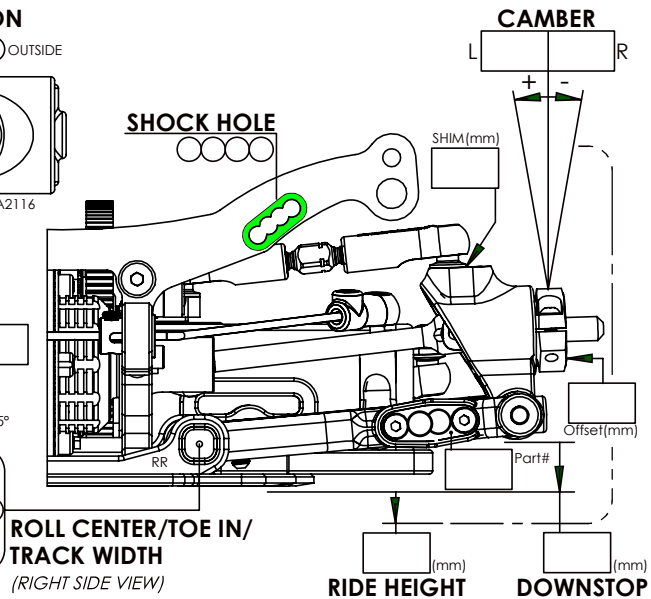

A2404

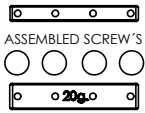

A2405

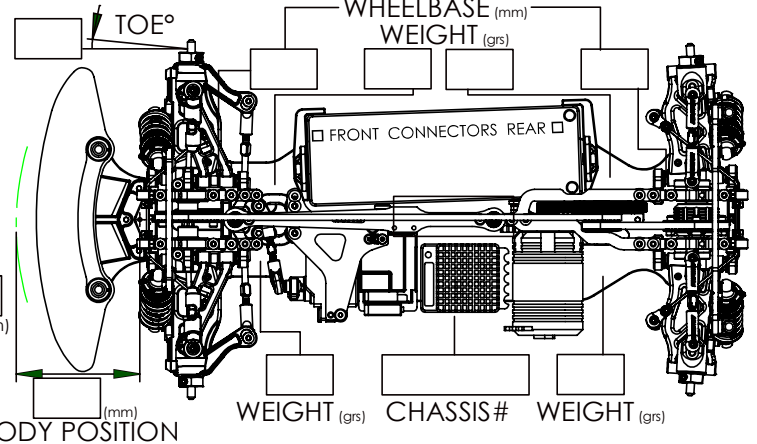
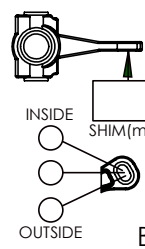

STEERING SHAFT MOUNTED ON

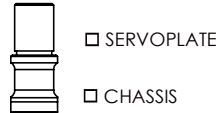

STEERING STOPPER A2304/A2305/A2306

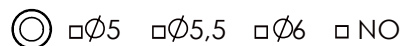

NOTES: