

**TRACK CONDITION**

ENVIRONMENT: INDOOR  OUTDOOR   
 COMPOSITION: CARPET  ASPHALT   
 TRACTION: LOW  MEDIUM  HIGH   
 LAYOUT: SLOW  MIXED  FAST   
 SURFACE: BUMPY  SMOOTH   
 NOTE: \_\_\_\_\_

**ELECTRONICS**

MOTOR: \_\_\_\_\_ TIMING: \_\_\_\_\_  
 PINION: \_\_\_\_\_ SPUR: \_\_\_\_\_  
 ESC: \_\_\_\_\_  
 BATTERY: \_\_\_\_\_  
 SERVO: \_\_\_\_\_  
 RECEIVER: \_\_\_\_\_

**SHOCK ABSORBERS**

FRONT \_\_\_\_\_ REAR \_\_\_\_\_  
 PISTON: \_\_\_\_\_ PISTON: \_\_\_\_\_  
 OIL: \_\_\_\_\_ OIL: \_\_\_\_\_  
 SPRING: \_\_\_\_\_ SPRING: \_\_\_\_\_  
 REBOUND: \_\_\_\_\_ REBOUND: \_\_\_\_\_  
 NOTE: \_\_\_\_\_

**ANTI-ROLL BAR**

FRONT: 1.2  1.3  1.4  1.5  \_\_\_\_\_   
 REAR: 1.1  1.2  1.3  1.4  \_\_\_\_\_

**TIRES & WHEELS**

TIRE: \_\_\_\_\_  
 INSERT: \_\_\_\_\_  
 WHEEL: \_\_\_\_\_  
 TREATMENT: \_\_\_\_\_  
 NOTE: \_\_\_\_\_

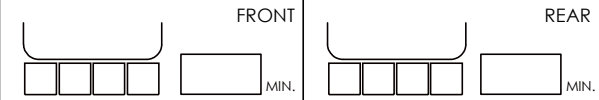

**SERVO SAVER POSITION**



**TRANSMISSION HEIGHT**

SPOOL \_\_\_\_\_ DIFFERENTIAL \_\_\_\_\_  
 HIGH  HIGH  OIL: \_\_\_\_\_  
 LOW  LOW

**FLEX**

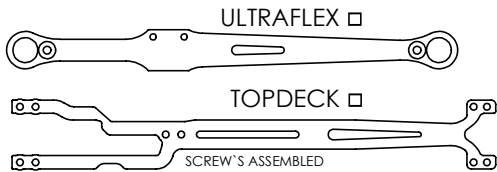

**AERODYNAMICS**

BODY: \_\_\_\_\_  
 WING: \_\_\_\_\_

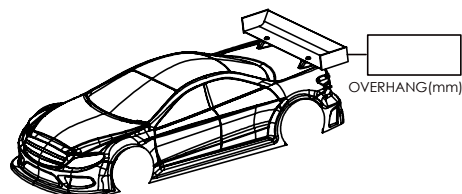

OVERHANG(mm)

**CASTER POSITION**

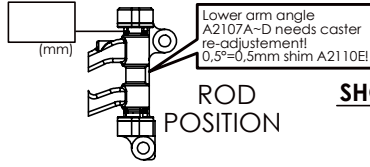

FF: A2105A/A2104  
1pc.  2pcs.

FR: A2105B/A2104  
1pc.  2pcs.

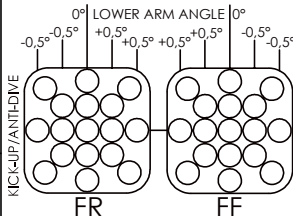

KICK-UP/ANTI-DIVE

**CAMBER LINK POSITION**

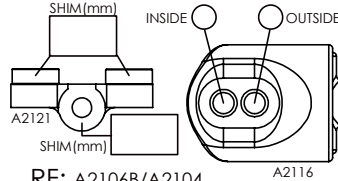

RF: A2106B/A2104  
1pc.  2pcs.

RR: A2106A/A2104  
1pc.  2pcs.

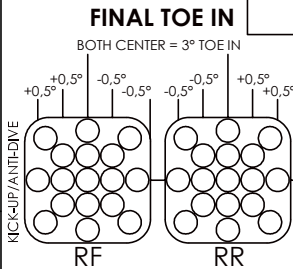

KICK-UP/ANTI-DIVE

**A2404**

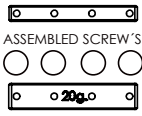

**A2405**

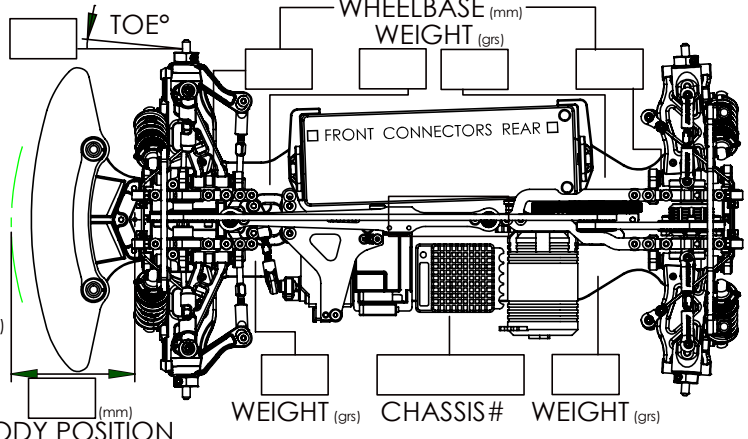
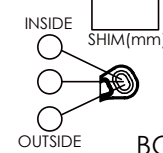
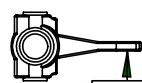

**STEERING SHAFT MOUNTED ON**

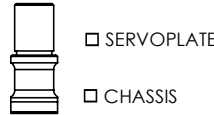

**STEERING STOPPER** A2304/A2305/A2306

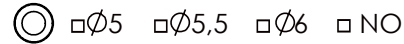

**NOTES:**

\_\_\_\_\_