





TE03Pro Setup Sheet

Capricorn RC

FRONT YES NO   REAR YES NO  

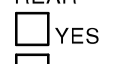
Race

Track

Name

City

Date

Air Temp. Track Temp.

Qualifying Best Lap sec Final Position Race Length min

TRACK CONDITION Carpet Asphalt Indoor Outdoor Bumpy Smooth Technical Mixed Fast Low Medium High

FRONT **REAR**

GEAR DIFF. CST CST

SPOOL NUMBER OF GEAR 2 4 2 4

PINION T SPUR T

INT. RATIO 2.0 RATIO

OIL OIL

PISTON PISTON

SPRING SPRING

REBOUND REBOUND

TIRES

WHEEL

ADDITIVE

SURFACE

CHASSIS TYPE Std XFlex Aluminum

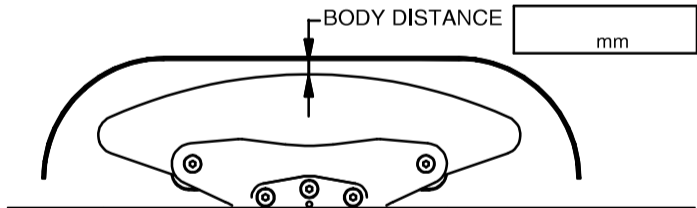

BODY

WING

UPPER DESK STD BRIDGE

BRIDGE LINK FRONT REAR

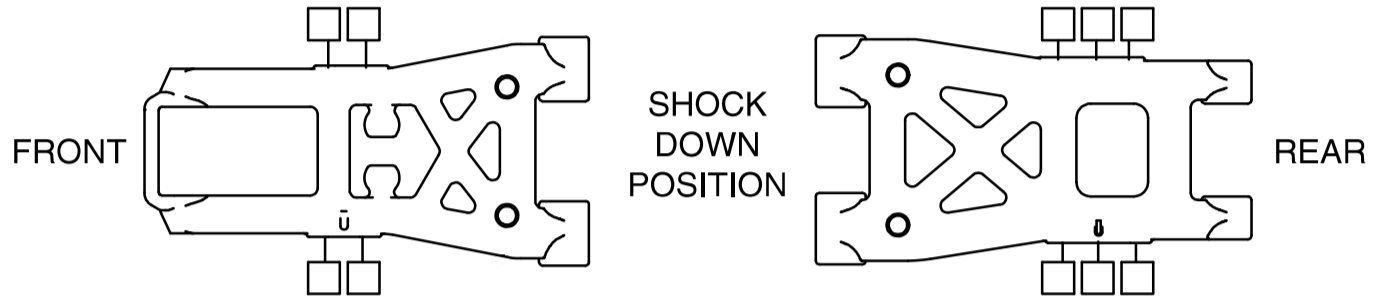
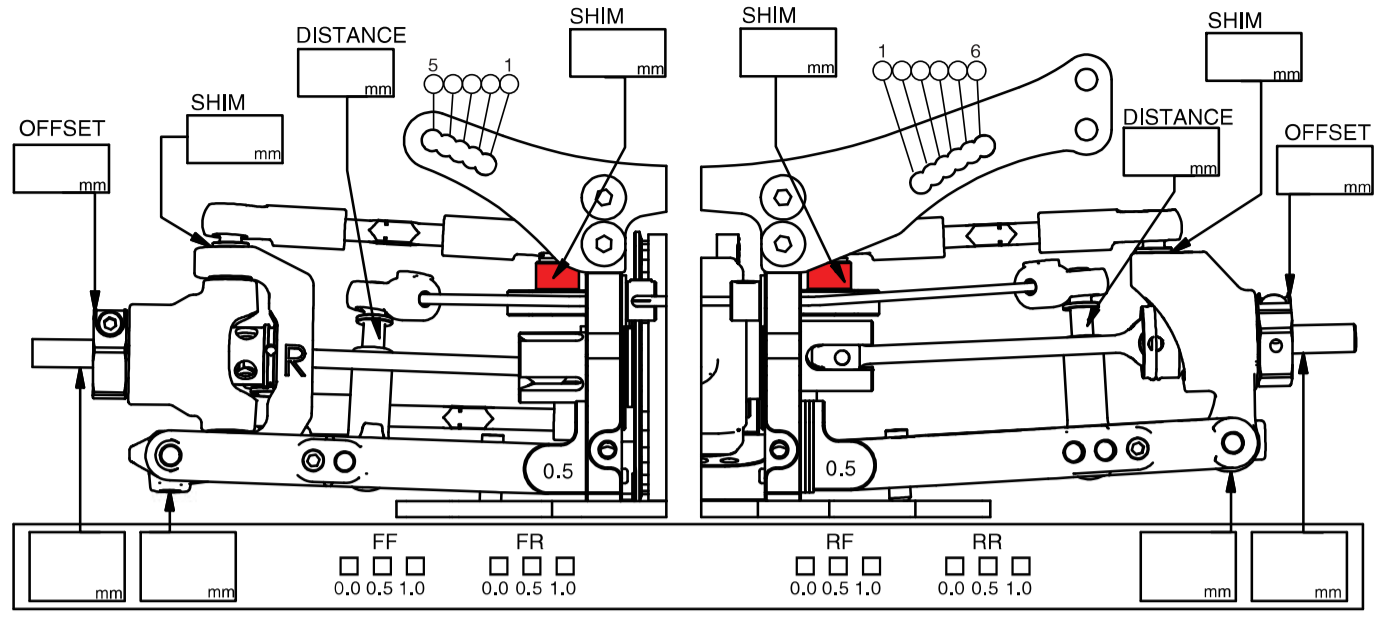

CAMBER

