

NAME \_\_\_\_\_  
 COUNTRY \_\_\_\_\_  
 RACE \_\_\_\_\_  
 TRACK \_\_\_\_\_

DATE \_\_\_\_\_ TEMP. °C AIR / TRACK \_\_\_\_\_ /  
 ASPHALT  (OUTDOOR  INDOOR  ) CARPET   
 TRACK CONDITION TECHNICAL  MIXED  FAST   
 TRACTION LOW  MEDIUM  HIGH

### FRONT

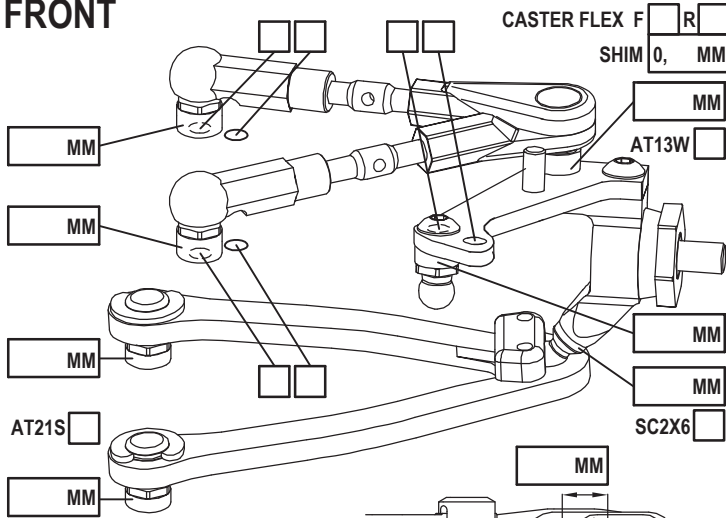

CAMBER ANGLE / ° \_\_\_\_\_  
 CASTER ANGLE / ° \_\_\_\_\_  
 TOE ANGLE / ° \_\_\_\_\_  
 RIDE HEIGHT / MM \_\_\_\_\_  
 DOWNSTOP / MM \_\_\_\_\_  
 UPWNSTOP / MM \_\_\_\_\_  
 STABILIZER Ø / MM \_\_\_\_\_  
 LOW ARM C04M1    
 STEER. ARM AM14A    
 WHEEL SPACER / MM \_\_\_\_\_  
 FRONT DRIVE GD3  SPOOL  GB2B  LOW  HIGH   
 DIFF. OIL \_\_\_\_\_ DIFF WASHERS \_\_\_\_\_  
 DOGBONE DRIVE ST17  ST11  ST12  BB  ST02   
 WHEELHUB AM06WL  AM06S-M  AM06W

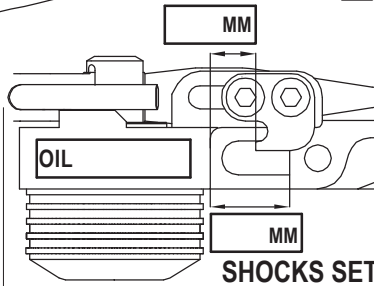

ROTOR STD    
 SPRING STD  S   
 DAMPER D2.2    
 ACTION SYM.  ASYM.   
 SRS/RHS ARR. I  II

### REAR

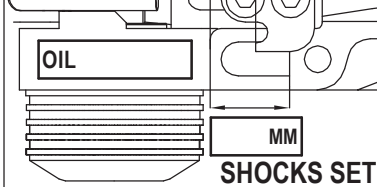
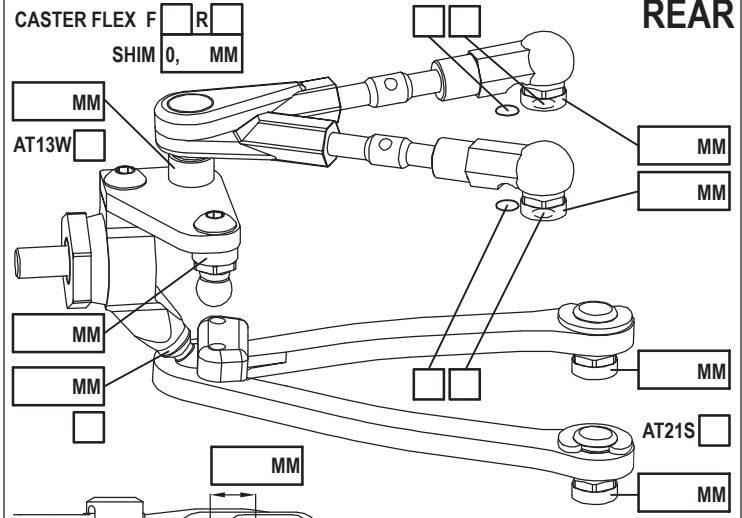

ROTOR STD    
 SPRING STD  S   
 DAMPER D2.2    
 ACTION SYM.  ASYM.   
 SRS/RHS ARR. I  II

CAMBER ANGLE / ° \_\_\_\_\_  
 CASTER ANGLE / ° \_\_\_\_\_  
 TOE ANGLE / ° \_\_\_\_\_  
 RIDE HEIGHT / MM \_\_\_\_\_  
 DOWNSTOP / MM \_\_\_\_\_  
 UPWNSTOP / MM \_\_\_\_\_  
 STABILIZER Ø / MM \_\_\_\_\_  
 LOW ARM C04M1    
 STEER. ARM AM23    
 WHEEL SPACER / MM \_\_\_\_\_  
 REAR DRIVE GD3R  GB2B  LOW  HIGH   
 DIFF. OIL \_\_\_\_\_ DIFF WASHERS \_\_\_\_\_  
 DOGBONE DRIVE ST11  ST12  BB  ST17  EVD   
 WHEELHUB AM06WL  AM06S-M  AM06W

### FRAME FLEX SETTING

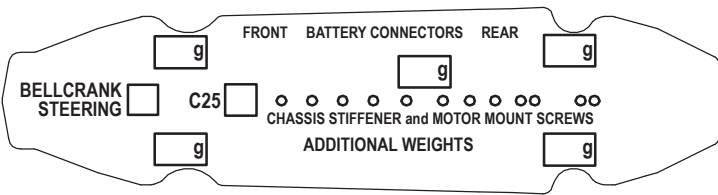

### LOWER DECK

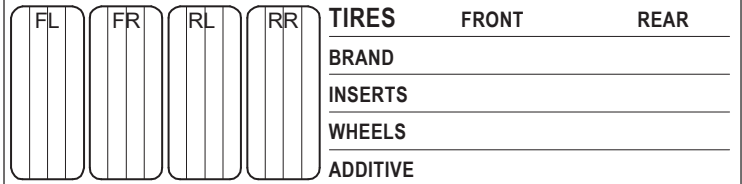
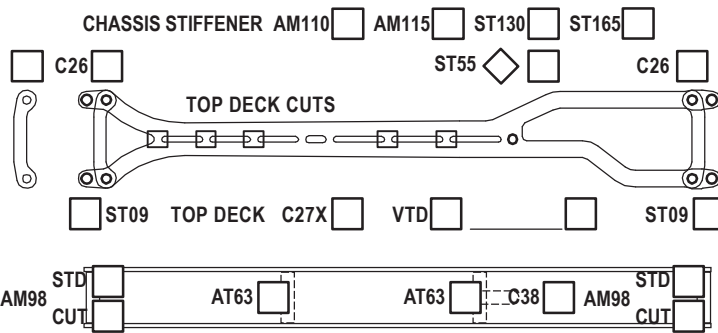

MOTOR LATERAL SHIFT / MM \_\_\_\_\_ ACKERMANN SHIMS / MM \_\_\_\_\_  
 MOTOR \_\_\_\_\_ SERVO \_\_\_\_\_  
 SPUR PINION RATIO \_\_\_\_\_ STEER TRAVEL IN \_\_\_\_\_ OUT \_\_\_\_\_  
 BODY \_\_\_\_\_ BATTERY \_\_\_\_\_  
 WING \_\_\_\_\_ RECEIVER \_\_\_\_\_  
 ESC \_\_\_\_\_ RADIO \_\_\_\_\_  
 ESC SETTING \_\_\_\_\_  
 BEST LAPTIME \_\_\_\_\_ QUALIF./FINAL POSITION \_\_\_\_\_ /  
 CONTACT \_\_\_\_\_

COMMENTS