

NAME _____
 COUNTRY _____
 RACE _____
 TRACK _____

DATE _____ TEMP. °C AIR / TRACK _____ /
 ASPHALT (OUTDOOR INDOOR) CARPET
 TRACK CONDITION TECHNICAL MIXED FAST
 TRACTION LOW MEDIUM HIGH

FRONT

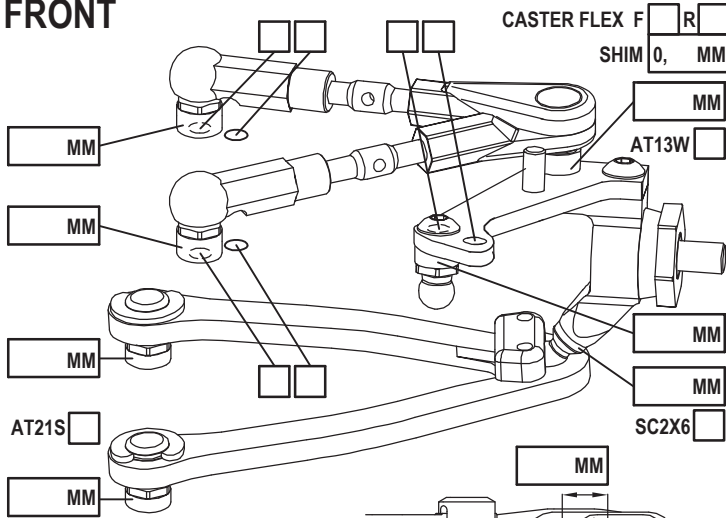

CAMBER ANGLE / ° _____
 CASTER ANGLE / ° _____
 TOE ANGLE / ° _____
 RIDE HEIGHT / MM _____
 DOWNSTOP / MM _____
 UPWNSTOP / MM _____
 STABILIZER Ø / MM _____
 LOW ARM C04M1
 STEER. ARM AM14A
 WHEEL SPACER / MM _____
 FRONT DRIVE GD3 SPOOL GB2B LOW HIGH
 DIFF. OIL _____ DIFF WASHERS _____
 DOGBONE DRIVE ST17 ST11 ST12 BB ST02
 WHEELHUB AM06WL AM06S-M AM06W

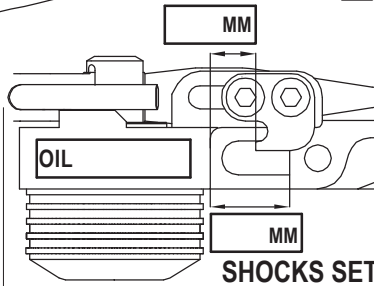

ROTOR STD
 SPRING STD S
 DAMPER D2.2
 ACTION SYM. ASYM.
 SRS/RHS ARR. I II

REAR

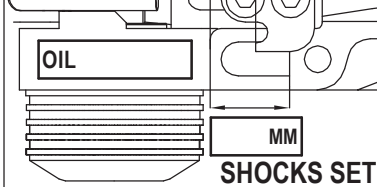
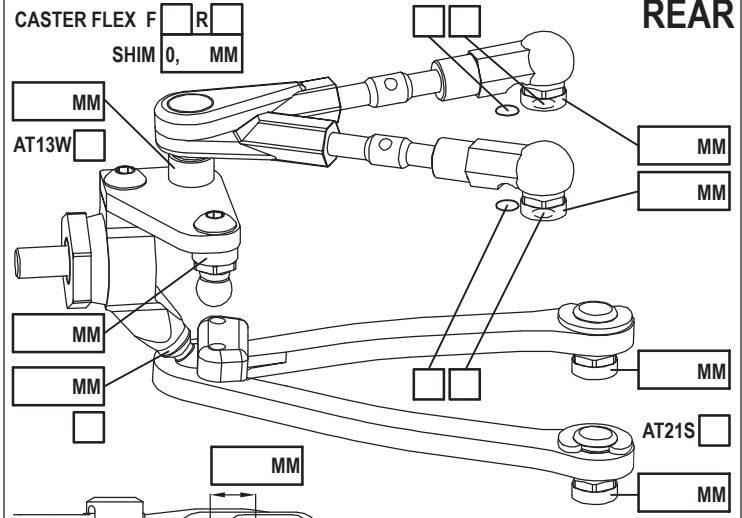

ROTOR STD
 SPRING STD S
 DAMPER D2.2
 ACTION SYM. ASYM.
 SRS/RHS ARR. I II

CAMBER ANGLE / ° _____
 CASTER ANGLE / ° _____
 TOE ANGLE / ° _____
 RIDE HEIGHT / MM _____
 DOWNSTOP / MM _____
 UPWNSTOP / MM _____
 STABILIZER Ø / MM _____
 LOW ARM C04M1
 STEER. ARM AM23
 WHEEL SPACER / MM _____
 REAR DRIVE GD3R GB2B LOW HIGH
 DIFF. OIL _____ DIFF WASHERS _____
 DOGBONE DRIVE ST11 ST12 BB ST17 EVD
 WHEELHUB AM06WL AM06S-M AM06W

FRAME FLEX SETTING

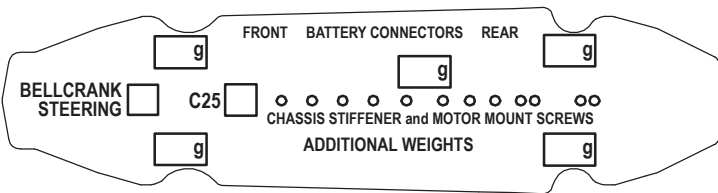

LOWER DECK

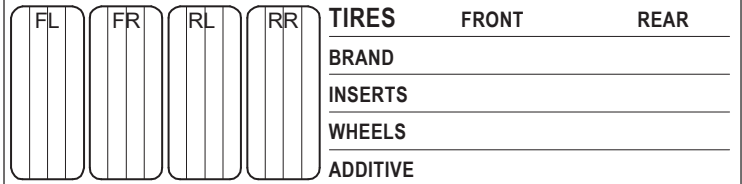
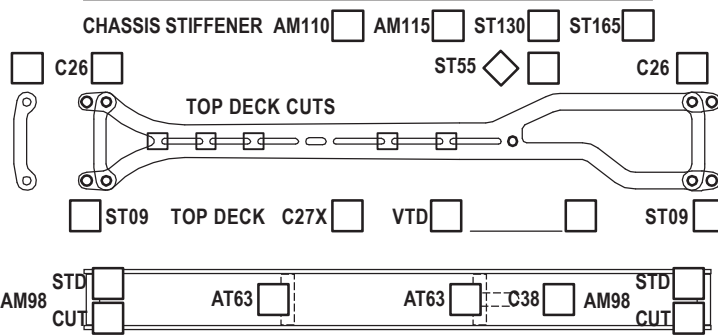

MOTOR LATERAL SHIFT / MM _____ ACKERMANN SHIMS / MM _____
 MOTOR _____ SERVO _____
 SPUR PINION RATIO _____ STEER TRAVEL IN _____ OUT _____
 BODY _____ BATTERY _____
 WING _____ RECEIVER _____
 ESC _____ RADIO _____
 ESC SETTING _____
 BEST LAPTIME _____ QUALIF./FINAL POSITION _____ /
 CONTACT _____

COMMENTS