

RACE

TRACK

NAME

CITY

DATE

TEMPERATURE		AIR	TRACK	
QUALIFYING	BEST LAP TIME	FINAL	RACE LENGTH	
	SEC		MIN	

TRACK CONDITION

CARPET     ASPHALT (  INDOOR     OUTDOOR )

BUMPY     SMOOTH

TECHNICAL     MIXED     FAST

TRACTION  LOW     MEDIUM     HIGH

TRANSMISSION

GEAR DIFF     CST    Number of Gears

SPOOL     2     4

MOTOR     ESC

PINION DP     T     SPUR GEAR DP     T

FINAL DRIVE RATIO (IR = 2.11)

SHOCK PDS CYLINDER

FRONT+PDS     REAR+PDS

FRONT		REAR	
<input type="text"/> CST	OIL <input type="text"/>	<input type="text"/> CST	
	SPRING <input type="text"/>		
	PISTON <input type="text"/>		
<input type="text"/> % REBOUND		<input type="text"/> %	

ANTI-ROLL BAR

FRONT  mm    REAR  mm

TIRES

FL     FR     RL     RR

TREATED AREA

TIRES

RIM

INSERTS

ADDITIVE

FL     FR     RL     RR

TREATED AREA

BODY MOUNT DISTANCE  mm

BODY     WING

STEER BLOCK SHIMS

STEER BLOCK SETUP

1.0mm / 0mm  
0.5mm / 0.5mm  
0mm / 1.0mm

R118041

BUMP STEER SHIMS  mm

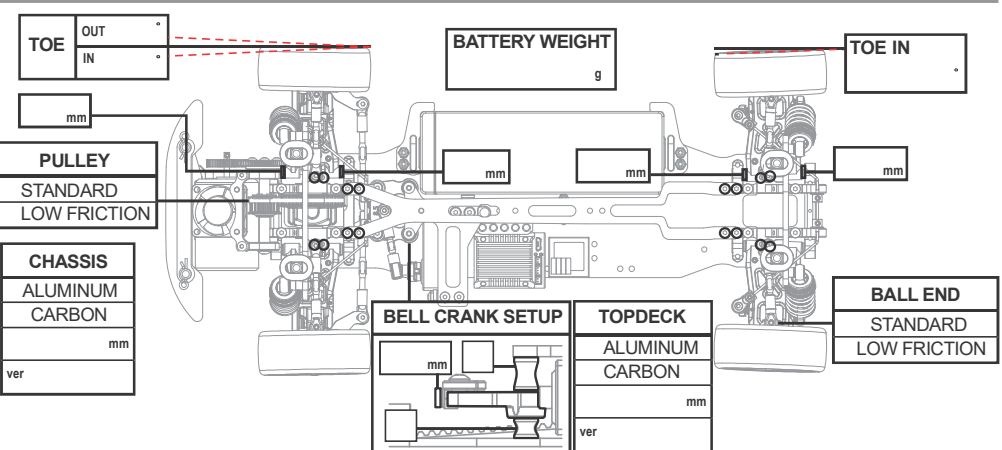
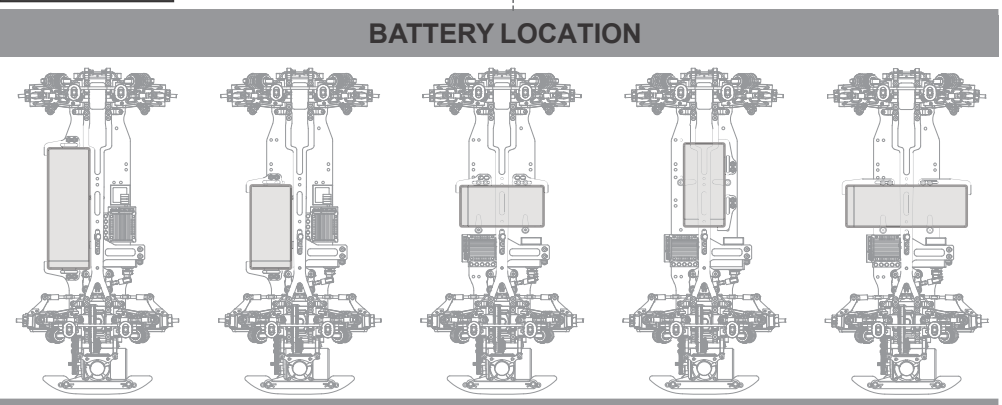
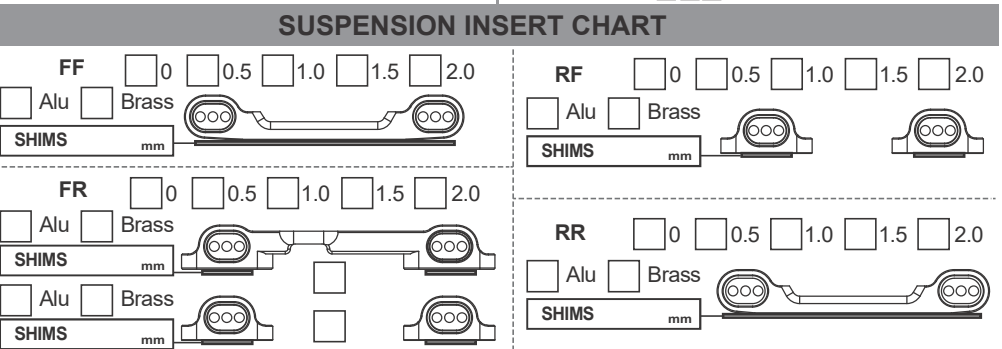
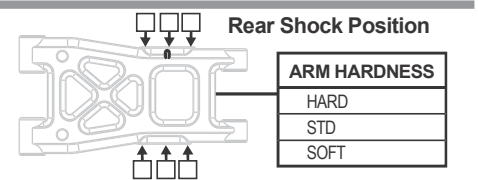
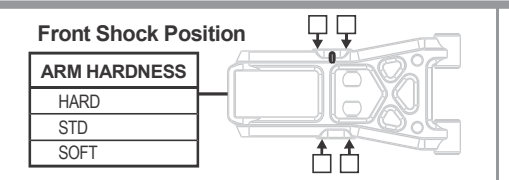
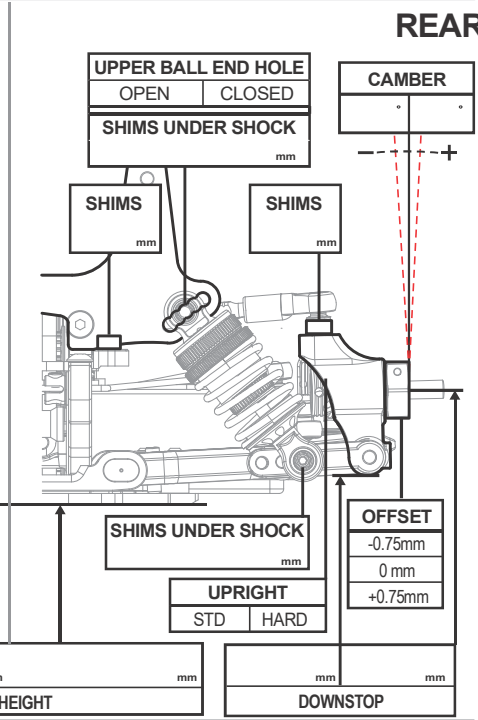
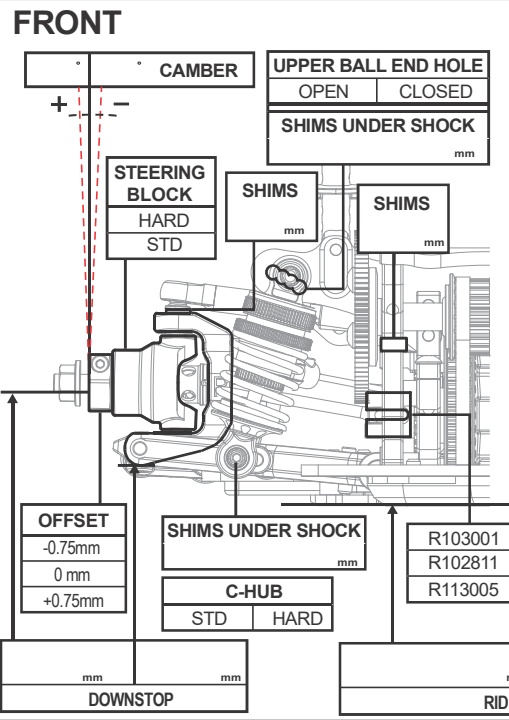

# NOTES